



**00103B**  
oliv/OD green

**US/BW T-Shirt**

klassisches Armee- T-Shirt,

halbarm, verstärkter Rundhals, 160 g/m<sup>2</sup>

Material: 100 % Baumwolle/Cotton

Größen/Sizes: S, M, L, XL, XXL, XXXL

**US/BW T-Shirt**

classic Army T-shirt, reinforced neck ring, 160 g/m<sup>2</sup>



**00103I**  
CCE tarn/CCE camo



**00103J**  
Typ 95 CZ tarn/CZ camo



**00103L**  
vegetato  
Größen/Sizes:  
XS, S, M, L, XL, XXL, XXXL



**00103M**  
grau/grey



**00103R**  
coyote



**00103T**  
woodland



**00103U**  
urban



**00103V**  
flecktarn/BW camo



**00103W**  
6 Farben desert/6 colour desert



**00103X**  
skyblue



**00103Y**  
BW tropentarn/BW tropical camo



**00103Z**  
3 Farben desert/3 colour desert



# Shirts



**00104A**  
digital-desert

### US T-Shirt

klassisches Armee-T-Shirt, in neuen Tarnfarben, verstärkter Rundhals, 170g/m<sup>2</sup>

Material: 100 % Baumwolle/Cotton

Größen/Sizes: S, M, L, XL, XXL, XXXL

### US T-Shirt

classic Army T-shirt in new camo colours, reinforced neck ring, 170g/m<sup>2</sup>



**00104B**  
digital-urban



**00104C**  
digital-woodland



**00104D**  
night-camo



**00104G**  
DPM-camo



**00104K**  
combat-camo



**00104M**  
vegetato desert  
Größen/Sizes: XS, S, M, L, XL, XXL, XXXL



**00105A**  
huntergrün/huntergreen



**00104O**  
BW winter-tarn/BW winter-camo



**00104Q**  
AT-digital



**00105E**  
huntersnow  
Größen/Sizes: S, M, L, XL, XXL, XXXL



**00105G**  
hunterbraun/hunterbrown

### US T-Shirt

halbarm, verstärkter Rundhals, 170g/m<sup>2</sup>

Material: 100 % Baumwolle/Cotton

Größen/Sizes: XS, S, M, L, XL, XXL, XXXL

### US T-Shirt

reinforced neck ring, 170g/m<sup>2</sup>





00153T  
woodland

**US/BW Tank-Top**

160g/m<sup>2</sup>

Material: 100 % Baumwolle/Cotton

Größen/Sizes: S, M, L, XL, XXL, XXXL

**US/BW Tank-Top**

160g/m<sup>2</sup>



00153A  
schwarz/black



00153B  
oliv/OD green



00153L  
weiß/white



00153U  
urban



00153V  
flecktarn/BW camo



00153X  
skyblue



00153Z  
3 Farben desert/3 colour desert



**BW Tank-Top**

mit Aufnäher „Bundeswehr“

Material: 100 % Baumwolle/Cotton

Größen/Sizes: S, M, L, XL, XXL, XXXL

**BW Tank-Top**

with patch „Bundeswehr“



00203A  
schwarz/black



00203L  
weiß/white





00109

Russ. Marine T-Shirt

halbarm

Material: 100 % Baumwolle/Cotton

Größen/Sizes: S, M, L, XL, XXL, XXXL

Russian marine T-Shirt

short-armed

00173

Russ. Marine Tank-Top

Material: 100 % Baumwolle/Cotton

Größen/Sizes: S, M, L, XL, XXL, XXXL

Russian marine tank-top





00114

**Russ. Marine Shirt, langarm**

Sommerausführung

Material: 100 % Baumwolle/Cotton

Größen/Sizes: S, M, L, XL, XXL

**Russian marine shirt, longsleeve  
summer**

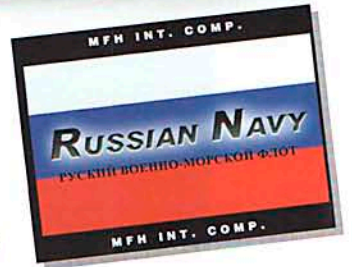

00682

**Russ. Marine Shirt, langarm**

Winterausführung

Material: 100 % Baumwolle/Cotton

Größen/Sizes: S, M, L, XL, XXL

**Russian marine shirt, longsleeve  
winter**



00113T

**US Tarn-Shirt, langarm**

woodland, verstärkter Rundhals, 160g/m<sup>2</sup>

Material: 100 % Baumwolle/Cotton

Größen/Sizes: S, M, L, XL, XXL

**US camo longsleeve-shirt**

woodland, reinforced neck ring, 160g/m<sup>2</sup>





00702A

T-Shirt, „Pro Company“

schwarz, verstärkter Rundhals, 160g/m<sup>2</sup>

Material: 100 % Baumwolle/Cotton

Größen/Sizes: S, M, L, XL, XXL, XXXL, 4XL

T-Shirt, „Pro Company“

black, reinforced neck ring, 160g/m<sup>2</sup>

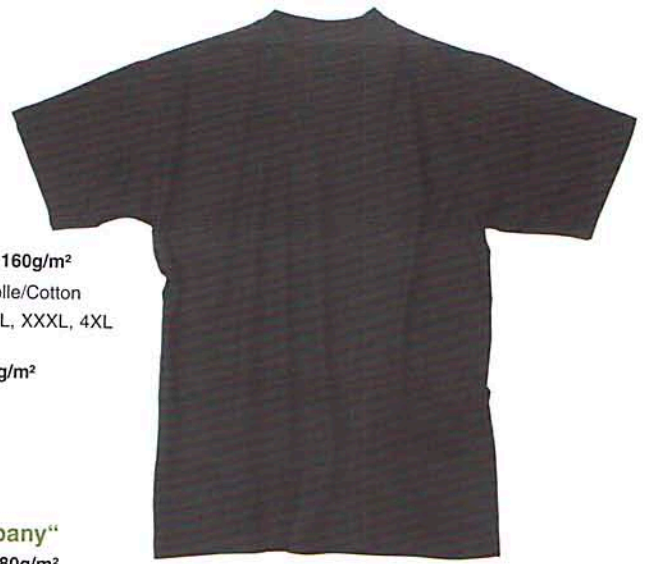

T-Shirt, „Pro Company“

verstärkter Rundhals, 180g/m<sup>2</sup>

Material: 100 % Baumwolle/Cotton

Größen/Sizes: S, M, L, XL, XXL

T-Shirt, „Pro Company“

reinforced neck ring, 180g/m<sup>2</sup>



00722G  
blau/blue



00722A  
schwarz/black  
Größen/Sizes: S, M, L, XL, XXL, XXXL



00722L  
weiß/white





00253M  
grau/grey



00253B  
oliv/OD green

**T-Shirt, „Army“**

bedruckt, verstärkter Rundhals

Material: 100 % Baumwolle/Cotton

Größen/Sizes: S, M, L, XL, XXL, XXXL

**T-Shirt, „Army“**

printed, reinforced neck ring



**00855A**

**T-Shirt, „Security“**

schwarz, bedruckt, verstärkter Rundhals

Material: 100 % Baumwolle/Cotton

Größen/Sizes: S, M, L, XL, XXL, 3XL, 4XL

**T-Shirt, „Security“**

black, printed, reinforced neck ring



**00873A**

**Poloshirt**

schwarz, rot-weiße Streifen, mit Knopfleiste

Material: 60 % Baumwolle/Cotton, 40 % Polyester

Größen/Sizes: S, M, L, XL, XXL, XXXL

**Poloshirt**

black, red-white stripes, button border



**00512L**

**Sweatshirt, „Deutschland“**

weiß, II. Wahl, leichte Verfärbung

Material: 100 % Baumwolle/Cotton

Größen/Sizes: S, M, L, XL, XXL

**Sweatshirt, „Germany“**

white, second quality, with stain





00933U  
urban



00933A  
schwarz/black



00933T  
woodland



**US T-Shirt, Damen**

klassisches Armee-T-Shirt im tailliertem Damen-Schnitt

Material: 100 % Baumwolle/Cotton

Größen/Sizes: S, M, L, XL, XXL

**US T-shirt, ladies**

classic Army T-shirt for ladies, slightly waisted



00943T  
woodland



00943U  
urban



00943V  
fleckarn/BW Camo  
Größen/Sizes: L, XL



00943Y  
BW tropentarn/  
BW tropical camo



**US Tank-Top, Damen**

im tailliertem Damen-Schnitt

Material: 100 % Baumwolle/Cotton

Größen/Sizes: S, M, L, XL, XXL

**US Tank Top, ladies**

in ladies-cut, waisted







00953T  
woodland



00953U  
urban

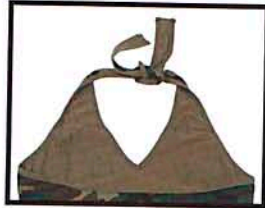

**Neckholder**

V-Neck, im Nacken zum Binden

Material: 100 % Baumwolle/Cotton

Größen/Sizes: XS, S, M, L, XL

**Neckholder shirt**

neck attaching



**String-Tanga**

Material: 86 % Nylon, 14 % Elasthan

**String-Tanga**



11801T  
woodland  
Größen/Sizes: XS



11801U  
urban  
Größen/Sizes: S, M, L





00353A  
schwarz/black T104

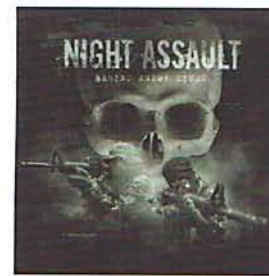

00353B  
schwarz/black T103

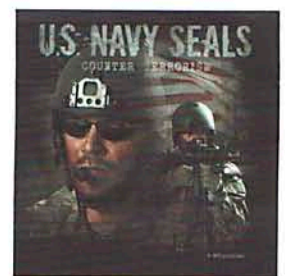

00353C  
schwarz/black T106

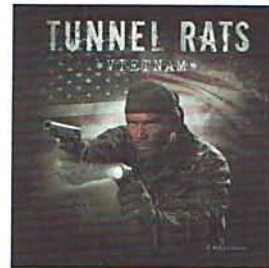

00353D  
schwarz/black T107

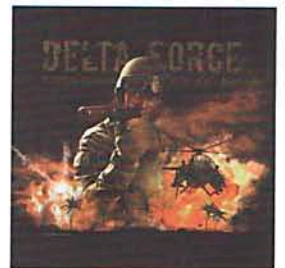

00353E  
schwarz/black T108



00353F  
schwarz/black T109

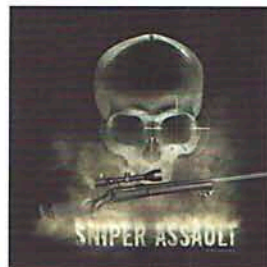

00353G  
schwarz/black T110

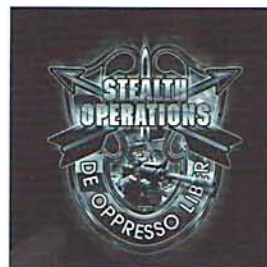

00353H  
schwarz/black T111



00353I  
schwarz/black T126

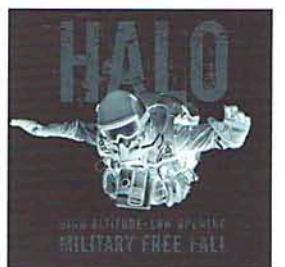

00353J  
schwarz/black T118



00353K  
schwarz/black T114

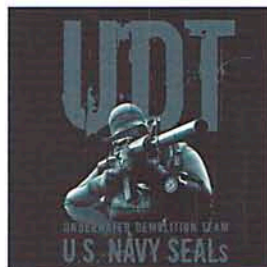

00353L  
schwarz/black T117



00353M  
schwarz/black T119

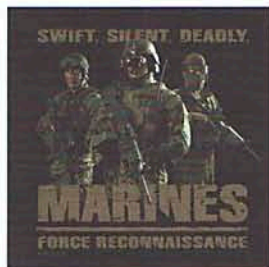

00353N  
schwarz/black T122



00353O  
schwarz/black T123



00353P  
schwarz/black T124

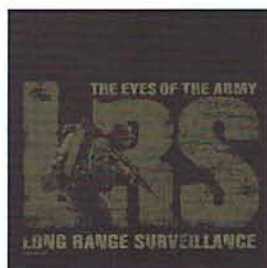

00353Q  
schwarz/black T125



00353R  
oliv/OD green T127



00353S  
schwarz/black T130

T-Shirt „MILpictures“  
bedruckt, verstärkter Rundhals  
Material: 100 % Baumwolle/Cotton  
Größen/Sizes: S, M, L, XL, XXL  
T-Shirt „MILpictures“  
printed, reinforced neck ring

**MILpictures**  
[www.milpictures.com](http://www.milpictures.com)



00532B  
oliv/OD green

T-Shirt, „Vintage“  
halbarm, verstärkter Rundhals, Pure Trash  
Material: 100 % Baumwolle/Cotton  
Größen/Sizes: S, M, L, XL, XXL  
T-Shirt, „Vintage“  
reinforced neck ring



00532A  
schwarz/black



00532L  
weiß/white



00565  
T-Shirt, „Vintage“  
Pure Trash, Applikation, blau-gelb,  
verstärkter Rundhals  
Material: 100 % Baumwolle/Cotton  
Größen/Sizes: S, M, L, XL, XXL  
T-Shirt, „Vintage“  
blue-yellow, reinforced neck ring



# Shirts



00566

T-Shirt, „Vintage“

Pure Trash, Applikation, oliv, verstärkter Rundhals

Material: 100 % Baumwolle/Cotton

Größen/Sizes: S, M, L, XL, XXL

T-Shirt, „Vintage“

OD green, reinforced neck ring, application

00572

Achsel-Shirt, „Vintage“

Pure Trash, mit Knopfleiste, schwarz

Material: 100 % Baumwolle/Cotton

Größen/Sizes: S, M, L, XL, XXL

Tank Top, „Vintage“

button border, black

00571

Achsel-Shirt, „Vintage“

Pure Trash, oliv

Material: 100 % Baumwolle/Cotton

Größen/Sizes: S, M, L, XL, XXL

Tank Top, „Vintage“

OD green



00561

Poloshirt, „Vintage“

Pure Trash, geschnürt, grau-gelb

Material: 100 % Baumwolle/Cotton

Größen/Sizes: S, M, L, XL, XXL

Poloshirt, „Vintage“

laced, grey-yellow



00562

Poloshirt, „Vintage“

Pure Trash, geschnürt, grau-gelb, washed

Material: 100 % Baumwolle/Cotton

Größen/Sizes: S, M, L, XL, XXL

Poloshirt, „Vintage“

laced, grey-yellow, washed



00563

Poloshirt

Pure Trash, mit Knopfleiste, blau

Material: 100 % Baumwolle/Cotton

Größen/Sizes: S, M, L, XL, XXL

Poloshirt

with button border, blue





00552B  
oliv/OD green



00552A  
schwarz/black

**Langarm-Shirt, „Vintage“**

Pure Trash, verstärkter Rundhals  
Material: 100 % Baumwolle/Cotton  
Größen/Sizes: XS, S, M, L, XL, XXL  
**Long sleeve shirt, „Vintage“**  
reinforced neck ring



00568

**Langarm-Shirt, „Vintage“**

Pure Trash, oliv, verstärkter Rundhals  
Material: 100 % Baumwolle/Cotton  
Größen/Sizes: S, M, L, XL, XXL  
**Long sleeve shirt, „Vintage“**  
OD green, reinforced neck ring





00570

**Langarm-Shirt**

Pure Trash, grau-blau, gestreift  
 Material: 100 % Baumwolle/Cotton  
 Größen/Sizes: S, M, L, XL, XXL  
**Long sleeve shirt**  
 grey-blue, striped



00569

**Langarm-Shirt**

Pure Trash, mit Kapuze, oliv-blau, gestreift  
 Material: 100 % Baumwolle/Cotton  
 Größen/Sizes: S, M, L, XL, XXL  
**Long sleeve shirt**  
 with hood, OD green/blue, striped





00575

Kapuzen-Sweatshirtjacke, „Vintage“

Pure Trash, 2 Einschubtaschen, Reißverschluss, schwarz

Material: 100 % Baumwolle/Cotton

Größen/Sizes: S, M, L, XL, XXL

Hooded sweatshirt jacket, „Vintage“

Pure Trash, 2 slanted pockets, with zipper, black



00582B

oliv/OD green

Größen/Sizes: M, L, XL, XXL

Kapuzen-Sweatshirtjacke, „Vintage“

Pure Trash, Beuteltasche am Bauch, Reißverschluss

Material: 100 % Baumwolle/Cotton

Hooded sweatshirt jacket, „Vintage“

Pure Trash, pouch pocket, with zipper



00582A

schwarz/black

Größen/Sizes: M, XL







00583

**Strickjacke mit Kapuze**

Pure Trash, grau-schwarz, Beuteltasche am Bauch, Reißverschluss, Bündchen am Bund und Ärmel

Material: 80 % Baumwolle/Cotton, 20 % Polyester

Größen/Sizes: S, M, L, XL, XXL

**Hooded sweatshirt jacket**

grey-black, Pure Trash, pouch pocket, with zipper, cuffs

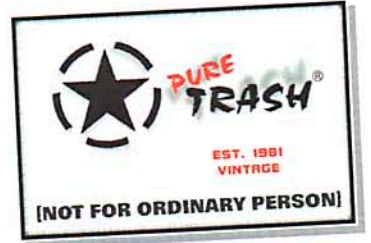

00584

**Sweatshirtjacke mit Kapuze**

Pure Trash, schwarz, 2 Einschubtaschen, abgedeckter Reißverschluss, Bündchen am Bund und Ärmel

Material: 80 % Baumwolle/Cotton, 20 % Polyester

Größen/Sizes: S, M, L, XL, XXL

**Hooded sweater**

black, Pure Trash, 2 slanted pockets, covered zipper, with cuffs





00585

**Kapuzensweatjacke**

oliv, Pure Trash, mit Beuteltasche, abgedeckter Reißverschluss, Bündchen am Bund und Ärmel

Material: 80 % Baumwolle/Cotton, 20 % Polyester

Größen/Sizes: S, M, L, XL, XXL

**Hooded sweatshirt jacket**

OD green, Pure Trash, pouch pocket, covered zipper, with cuffs

00586

**Sweatshirtjacke**

Pure Trash, schwarz, 2 Einschubtaschen mit Reißverschluss, Bündchen am Bund und Ärmel, Schulter-, Kragen- und Ärmelbesatz, abgedeckter Reißverschluss

Material: 80 % Baumwolle/Cotton, 20 % Polyester

Größen/Sizes: S, M, L, XL, XXL

**Sweatshirt jacket**

Pure Trash, black, 2 slanted pockets with zipper, with cuffs, patch on the shoulders, collar and sleeves, covered zipper





**00622A**  
schwarz/black  
Größen/Sizes:  
S, M, L, XL, XXL, XXXL, 4XL



**00622T**  
woodland  
Größen/Sizes:  
XS, S, M, L, XL, XXL



**00622K**  
night-camo  
Größen/Sizes:  
S, M, L, XL, XXL, XXXL



**00622U**  
urban  
Größen/Sizes:  
S, M, L, XL, XXL, XXXL

**Kapuzen-Sweatshirt-Jacke**  
Beuteltasche am Bauch, Reißverschluss,  
Bündchen am Bund und Ärmel, 340g/m<sup>2</sup>  
Material: 80 % Baumwolle/Cotton,  
20 % Polyester  
**Hooded sweater jacket**  
pouch pocket, zipper, with cuffs, 340g/m<sup>2</sup>



**00602A**  
**Sweatshirt**  
schwarz, Bündchen am Bund und Ärmel,  
verstärkter Rundhals, 340g/m<sup>2</sup>  
Material: 80 % Baumwolle/Cotton  
20 % Polyester  
Größen/Sizes: S, M, L, XL, XXL, XXXL, 4XL  
**Sweatshirt**  
with cuffs, black, reinforced neck ring, 340g/m<sup>2</sup>





00612A

schwarz/black  
Größen/Sizes:

XS, S, M, L, XL, XXL, XXXL, 4XL



00612K

night-camo  
Größen/Sizes:

XS, S, M, L, XL, XXL, XXXL



00612T

woodland  
Größen/Sizes:  
XS, S, M, L, XL, XXL



00612U

urban  
Größen/Sizes:  
XS, S, M, L, XL, XXL

**Kapuzen-Sweatshirt**

Beuteltasche am Bauch,  
Bündchen am Bund und Ärmel, 340g/m<sup>2</sup>

Material: 80 % Baumwolle/Cotton,  
20 % Polyester

**Hooded sweatshirt**

pouch pocket, with cuffs, 340g/m<sup>2</sup>



00652T  
woodland



00652A  
schwarz/black

**Kapuzen-Sweatshirt, Damen**

Beuteltasche am Bauch,  
Bündchen am Bund und Ärmel, 340g/m<sup>2</sup>

Material: 80 % Baumwolle/Cotton,  
20 % Polyester

Größen/Sizes: S, M, L, XL

**Hooded sweatshirt, ladies**

pouch pocket, with cuffs, 340g/m<sup>2</sup>

**Kapuzen-Sweatshirt-Jacke, Damen**

Beuteltasche am Bauch, Reißverschluss,  
Bündchen am Bund und Ärmel, 340g/m<sup>2</sup>

Material: 80 % Baumwolle/Cotton,  
20 % Polyester

Größen/Sizes: S, M, L, XL

**Hooded sweatshirt jacket, ladies**

pouch pocket, zipper, with cuffs, 340g/m<sup>2</sup>



00662T  
woodland



00662A  
schwarz/black



**01101B**  
oliv/OD green



**01101A**

schwarz/black  
Größen/Sizes:

1, 2, 3, 4, 5, 6, 7, 8, 9, 10, 11, 12, 13, 14, 15

**01102A** schwarz/black

**BW Moleskinhose, groß**

Größen/Sizes: 58, 60, 62, 64, 66

**BW field pants, large sizes**

**01102B** oliv/OD green

**BW Moleskinhose, groß**

Größen/Sizes: 58, 60, 62, 64, 66, 28, 29, 30, 31

**BW field pants, large sizes**



**BW Moleskinhose**

original BW Moleskinhose, mit 2 seitl. Einschubtaschen, Gesäßtasche, 2 seitl. aufgesetzte Bein-Pattentaschen

Material: 100 % Baumwolle/Cotton

Größen/Sizes: 38, 40, 1, 2, 3, 4, 5, 6, 7, 8, 9, 10, 11, 12, 13, 14, 15

**BW field pants**

the original BW field pants, with 2 button-down cargo pockets, 1 back pocket, 2 side flap pockets



**01155B** oliv/OD green

**BW Moleskinhose mit Steppfutter**

2 seitl. Einschubtaschen, Gesäßtasche,  
2 seitl. aufgesetzte Bein-Pattentaschen

Material: 100 % Baumwolle/Cotton

Innenmaterial/Lining: 100 % Baumwolle/Cotton

Futter/Padding: 100 % Polyester

Größen/Sizes: 2, 3, 4, 4,5, 5, 6, 7, 8, 9, 10, 11, 12, 13, 14, 15

**BW field pants, lining**

2 button-down cargo-pockets, 1 back pocket,  
2 side flap pockets

**01165B** oliv/OD green

**BW Moleskinhose, groß**

Größen/Sizes: 58, 60, 62, 64, 28, 29, 30, 31

**BW field pants, large sizes**

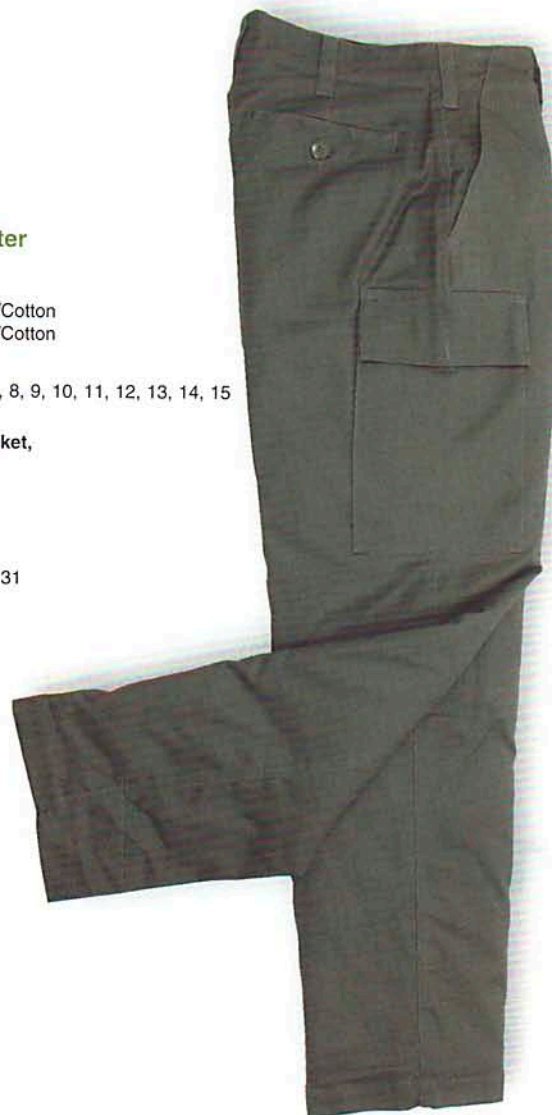



**011030**  
schwarz-stonewashed/  
black-stonewashed  
Größen/Sizes: 0-13



**01103P**  
oliv-stonewashed/  
OD green-stonewashed  
Größen/Sizes: 1-15



**01103S**  
khaki-stonewashed  
Größen/Sizes: 0, 1, 2, 6

**BW Moleskinhose, Mod., stonewashed**

Ein Nachbau der BW Moleskinhose in originalem Schnitt und identischem Material. 2 seittl. Einschubtaschen, Gesäßtasche, 2 seittl. aufgesetzte Bein-Pattentaschen

Material: 100 % Baumwolle/Cotton

**BW field pants**

a remake of the BW field pants with original cut and identical material, with 2 button-down cargo pockets, 1 back pocket, 2 side flap pockets



**01175A**

**US Kampfhose, gefüttert**

schwarz, 2 seittl. Einschubtaschen, 2 Gesäß-Pattentaschen, 2 seittl. aufgesetzte Bein-Pattentaschen, Bandzug am Beinende, verstellbare Taillenweite, doppelte Knie, doppelter Hintern, Reißverschluss am Hosenschlitz

Material: 65 % Polyester, 35 % Baumwolle/Cotton

Innenmaterial/Lining: 100 % Nylon

Futter/Padding: 100 % Polyester

Größen/Sizes: XS, S, M, L, XL, XXL, XXXL, 4XL

**US field pants, lining**

black, 2 front slash pockets, 2 back and 2 side flap pockets, drawstring ankle ties, adjustable waist tabs, reinforced seat and knees, zipper fly

**Franz. Feldhose F1**

Die klassische „F1“- Hose im originale Design!  
 2 geknöpfte Oberschenkeltaschen,  
 2 Schubtaschen vorne, RV am Hosenschlitz,  
 elastischer Beinabschluss, Kniebereich verstärkt

Material: 65 % Baumwolle/Cotton, 35 % Polyester

Größen/Sizes: S, M, L, XL, XXL

**French fieldpants F1**

The classic „F1“ - fieldpants in original design!  
 2 buttoned cargo pockets, 2 slanted pockets in front,  
 reinforced knees, zip fly, elastic bottom



01252B  
 oliv/OD green



01252I  
 CCE tarn/CCE camo



01255B  
 oliv/OD green



01255I  
 CCE tarn/CCE camo

**Franz. Feldhose F2**

Die klassische „F2“- Hose im originale Design!  
 2 geknöpfte Oberschenkeltaschen,  
 2 Schubtaschen vorne, RV am Hosenschlitz,  
 elastischer Beinabschluss mit Kordel,  
 Kniebereich verstärkt

Material: 65 % Baumwolle/Cotton, 35 % Polyester

Größen/Sizes: S, M, L, XL, XXL

**French fieldpants F2**

The classic „F2“ - fieldpants in original design!  
 2 buttoned cargo pockets, 2 slanted pockets in front,  
 zip fly, elastic bottom, reinforced knees



ORIGINAL MILSPEC



01264A  
schwarz/black



01264B  
oliv/OD green



01264T  
woodland

**US Kampfhose M65, original Ny/Co**

Die klassische US ARMY Hose, „M 65“, original Material, originales Design, 2 große Seitentaschen mit angenähten Bändern, 2 Gesäßtaschen mit Deckel und Druckknöpfe, 2 Schubtaschen mit Deckel und Druckknopf vorne, Bandzug am Beinende

Material: 50 % Nylon, 50 % Baumwolle/Cotton

Größen/Sizes: XXS, XS, S, M, L, XL, XXL

**US field pants M65, original, Ny/Co**

The classic US ARMY pants, „M 65“, original material, original design!

2 big cargo pockets with sewed on ribbons, 2 back pockets with flaps and push button, 2 front slash pockets with flaps and push button, drawstring ankle ties







**01294A**  
schwarz/black  
Größen/Sizes: S, M, L, XL, XXL, XXXL



**01294B**  
oliv/OD green



**01294F**  
khaki  
Größen/Sizes: S, M, L, XL, XXL



**01294T**  
woodland



**01294G**  
blau/blue



**01294U**  
urban



Sehr robust durch Verstärkung  
am Knie und Hintern!



**US Kampfhose BDU, Mod.**

klassische US Army Hose, 2 seittl. Einschubtaschen, 2 Gesäß-Pattentaschen, 2 seittl. aufgesetzte Bein-Pattentaschen, Bandzug am Beinende, verstellbare Taillenweite, doppelte Knie, doppelter Hintern, Knöpfe am Hosenschlitz

Material: 65 % Polyester, 35 % Baumwolle/Cotton

Größen/Sizes: XS, S, M, L, XL, XXL

**US BDU field pants**

classic US army pants, 2 front slash pockets, 2 back flap pockets, 2 cargo pockets, drawstring ankle ties, adjustable waist tabs, reinforced knees and seat, button fly





**01304A**  
schwarz/black  
Größen/Sizes:  
S, M, L, XL, XXL, XXXL



**01304B**  
oliv/OD green



**01324C**  
splinter-tarn/splinter-camo



**01324Y**  
BW tropentarn/  
BW tropical camo



**01304G**  
blau/blue



**01324Q**  
sumptarn/BGS camo



**01324T**  
woodland



**01324U**  
urban

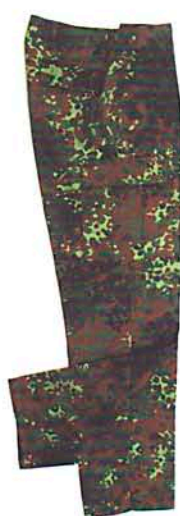

**01324V**  
flecktarn/BW camo



**01324W**  
6 Farben desert/6 colour desert



**01324X**  
skyblue



**01324Z**  
3 Farben desert/  
3 colour desert



### US Kampfhose BDU, Fashion Typ

2 seil. Einschubtaschen, 2 Gesäß-Pattentaschen, 2 seil. aufgesetzte Bein-Pattentaschen, Bandzug am Beinende, verstellbare Tailleweite, Reißverschluss am Hosenschlitz

Material: 65 % Polyester, 35 % Baumwolle/Cotton

Größen/Sizes: S, M, L, XL, XXL

### US BDU field pants, fashion type

2 front slash pockets, 2 back flap pockets, 2 cargo pockets, drawstring ankle ties, adjustable waist tabs, zipper fly

passende Jacken, Seite 58  
Artikel-Nr.: 03482



01352B  
oliv/OD green



01352A  
schwarz/black



01352T  
woodland



Sehr robust durch Verstärkung  
am Knie und Hintern!



#### Kommandohose, „Smock“

Rip Stop, 2 seitt. Einschubtaschen, 2 Gesäß-Pattentaschen, 2 seitt. aufgesetzte Bein-Pattentaschen mit Wasserösen, Gesäßverstärkung, verstärkter Kniebereich mit herausnehmbarer Polsterung, weitenverstellbarer Bund per Klett und Stellband, seitliche Reißverschlüsse am Beinabschluss, Hosenschlitz mit RV, Bandzug am Beinende

Material: 65 % Polyester, 35 % Baumwolle/Cotton

Größen/Sizes: S, M, L, XL, XXL, 3XL

#### Commandopants, „Smock“

rip stop, 2 side pockets, 2 back flap pockets, 2 side flap patch pockets with water eyelets, reinforced seat, reinforced knees with removable padding, adjustable waistband with velcro and adjustable pull tab, side zippers at the leg border, trouser fly with zipper, drawstring bottom



Hosen



01334A  
schwarz/black



01334B  
oliv/OD green



01334E  
hunter-snow



01334C  
tiger stripe

ORIGINAL MILSPEC



01334F  
khaki



01334G  
hunter-braun/hunter-brown



01334H  
hunter-grün/hunter-green



01334I  
CCE tarr/CCE camo



01334J  
Typ 95 CZ tarr/CZ camo



01334K  
night-camo



01334L  
vegetato



01334N  
snow tarr/snow camo





01334T  
woodland



01334U  
urban



01334V  
flecktarn/BW camo



01334W  
6 Farben desert/  
6 colour desert



01334Y  
BW tropentarn/  
BW tropical camo



01334Z  
3 Farben desert/  
3 colour desert



Sehr robust durch Verstärkung  
am Knie und Hintern!



ORIGINAL MILSPEC

**US Kampfhose BDU, Rip Stop**

Die klassische US ARMY Hose! RIP STOP,  
2 seittl. Einschubtaschen, 2 Gesäß-Pattentaschen, 2 seittl. aufgesetzte Bein-Pattentaschen,  
Bandzug am Beinende, verstellbare Taillenweite, doppelte Knie, doppelter Hintern,  
Knöpfe am Hosenschlitz

Material: 100 % Baumwolle/Cotton

Größen/Sizes: S, M, L, XL, XXL, XXXL

**US BDU field pants, rip stop**

The classic US ARMY pants! RIP-STOP,  
2 front slash pockets, 2 back flap pockets, 2 cargo pockets, drawstring ankle ties,  
adjustable waist tab, reinforced knees and seat, button fly



**US Kampf hose M65, Rip Stop**

Die klassische US ARMY Hose, „M65“,  
2 große Seitentaschen mit angenähten Bändern,  
2 Gesäßtaschen mit Deckel und Druckknöpfe,  
2 Schubtaschen mit Deckel und Druckknopf vorne,  
Bandzug am Beinende

Material: 100 % Baumwolle/Cotton

Größen/Sizes: XS, S, M, L, XL, XXL

**US BDU field pants, Rip stop**

Die klassische US ARMY pants „M65“,  
2 big cargo pockets with sewed on ribbons,  
2 back pockets with flaps and push button,  
2 front slash pockets with flaps and push button,  
drawstring bottom



01364T  
woodland-stonewashed



**Stonewashed**



01364A  
schwarz-stonewashed/  
black-stonewashed



01364B  
oliv-stonewashed/  
OD green-stonewashed

ORIGINAL MILSPEC

**US ACU Army-Combat-Uniform Hose, Rip Stop**

2 seittl. Einschubtaschen, 2 Gesäß-Pattentaschen,  
4 seittl. aufgesetzte Bein-Pattentaschen mit Klett,  
2 Einschubtaschen mit Klett im Kniebereich,  
doppelte Knie, doppelter Hintern, Bandzug am Beinende,  
Knöpfe am Hosenschlitz

Material: 100 % Baumwolle/Cotton

Größen/Sizes: S, M, L, XL, XXL, XXXL

**US ACU field pants, rip stop**

2 front slash pockets, 2 back flap pockets,  
4 side flap pockets on the legs with velcro,  
2 thrust in pockets with velcro on the knees,  
reinforced knees, reinforced seat,  
drawstring bottom, button fly



01383Q  
AT-digital



01383M  
vegetato desert



01383R  
coyote tan



01383S  
digital woodland

passende Jacken, Seite 63  
Artikel-Nr.: 03383





passende Jacken, Seite 62  
Artikel-Nr.: 03374, 03375



01374B  
oliv/OD green



01375B  
oliv-stonewashed/  
OD green-stonewashed



01375C  
tiger stripe-stonewashed



01374C  
tiger stripe

**US Kampfhose, „Vietnam“, Rip Stop**

Vietnam-Style, 2 seitliche Einschubtaschen, 2 Gesäß-Pattentaschen, 2 seitlich aufgesetzte Bein-Pattentaschen, Bandzug am Beinende, verstellbare Taillenweite, Reißverschluss am Hosenschlitz

Material: 100 % Baumwolle/Cotton

Größen/Sizes: S, M, L, XL, XXL

**US field pants, „Vietnam“, rip stop**

vietnam-style, 2 front slash pockets, 2 back flap pockets, 2 cargopockets, drawstring bottom, adjustable waist tab, zipper fly

*Stonewashed*

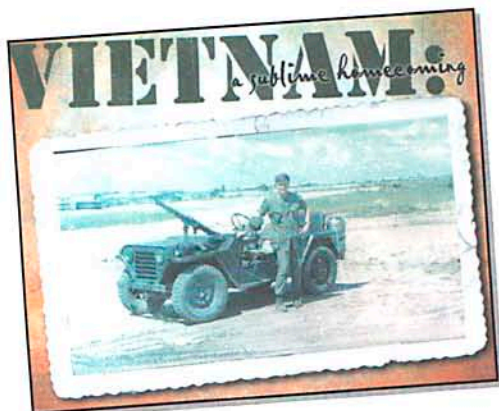





**01512A**  
schwarz/black  
Größen/Sizes:  
S, M, L, XL, XXL, XXXL



**01512C**  
tiger stripe



**01512F**  
khaki



**01512J**  
Typ 95 CZ tarn/CZ camo



**01512K**  
night-camo



**01512P**  
oliv-stonewashed/  
OD green-stonewashed



**01512S**  
woodland-stonewashed



**01512T**  
woodland



**01512Z**  
3 Farben desert/  
3 colour desert



**US BDU Bermuda, Rip Stop**

2 seittl. Einschubtaschen, 2 Gesäß-Pattentaschen,  
2 seittl. aufgesetzte Bein-Pattentaschen, verstellbare Taillenweite  
Material: 100 % Baumwolle/Cotton

Größen/Sizes: S, M, L, XL, XXL

**US BDU bermuda, rip stop**

2 front slash pockets, 2 back flap pockets, 2 cargo pockets,  
adjustable waist tabs



**01512B**  
oliv/OD green



**01453P**  
oliv-stonewashed/OD green-stonewashed



**01453O**  
schwarz-stonewashed/black-stonewashed

**BW Moleskin-Bermuda, stonewashed**

2 seittl. Einschubtaschen, Gesäßtasche,  
2 seitlich aufgesetzte Bein-Pattentaschen  
Material: 100 % Baumwolle/Cotton

Größen/Sizes: S, M, L, XL, XXL, XXXL, 4XL

**BW moleskin-bermuda, stonewashed**

2 front slash pockets, back pocket, 2 cargo pockets



alle Teile mit  
Pure Trash-Flaschenöffner



**01403K**  
combat camo-stonewashed

**Bermuda, „Combo“**

2 Einschubtaschen vorne, 2 Gesäßtaschen, 2 seitlich aufgesetzte Beintaschen, alle Taschen mit Druckknopf, abgedeckter Reißverschluss am Hosenlatz, Verstellbänder in der Taille und am Beinabschluss

Material: 100 % Baumwolle/Cotton

Größen/Sizes: XS, S, M, L, XL, XXL

**Bermuda, „Combo“**

2 front slash pockets, 2 back pockets, 2 cargo pockets, all pockets with snaps, covered zipper fly, adjustable waist tabs and drawstring bottom



**01403A**  
schwarz-stonewashed/  
black-stonewashed  
Größen/Sizes: S, M, L, XL, XXL, XXXL



**01403B**  
oliv-stonewashed/  
OD green-stonewashed  
Größen/Sizes: S, M, L, XL, XXL, XXXL



**01403F**  
khaki-stonewashed



**01403T**  
woodland-stonewashed



**01413K**  
combat camo-stonewashed



**01413B**  
oliv-stonewashed/OD green-stonewashed



**01413D**  
night camo-stonewashed

**Bermuda, „Neon“**

2 Einschubtaschen mit jeweils einer kleinen Zusatztasche vorne, 2 Gesäß- und 2 seittl. Beintaschen mit Druckknopf, doppelter Hintern, Beine unten zum Krempeln, abgedeckte Knopfleiste am Hosenlatz, Verstellbänder in der Taille und am Beinabschluss

Material: 100 % Baumwolle/Cotton

Größen/Sizes: XS, S, M, L, XL, XXL

**Bermuda, „Neon“**

2 front slash pockets with small additional pocket in front, 2 back and 2 cargo pockets with buttons, reinforced seat, covered zipper fly, adjustable waist tabs and drawstring bottom



**01414B**  
hell oliv-stonewashed/  
light OD green-stonewashed



**01414Z**  
3 Farben desert-stonewashed/  
3 colour desert-stonewashed



**01414M**  
grau/blau-stonewashed/grey/blue-stonewashed

**Bermuda, „Trinity“**

2 Einschubtaschen vorne, 2 Gesäß- und 2 seittl. aufgesetzte Beintaschen mit Knöpfe, abgedeckte Knopfleiste am Hosenlatz, Verstellbänder in der Taille und am Beinabschluss, doppelter Hintern

Material: 100 % Baumwolle/Cotton

Größen/Sizes: XS, S, M, L, XL, XXL

**Bermuda, „Trinity“**

2 front slash pockets, 2 back pockets and 2 cargo pockets with buttons, covered zipper fly, adjustable waist tabs and drawstring ankle ties, reinforced bottom





01433M

grau camo-stonewashed/  
grey camo-stonewashed



01433B

oliv-stonewashed/OD green-stonewashed



01433F

khaki-stonewashed



01433Z

3 Farben desert-stonewashed/  
3 colour desert-stonewashed  
Größen/Sizes: S, M



01433T

woodland-stonewashed

**Bermuda, „Eagle1“**

robuste Bermuda von Pure Trash aus Canvasmaterial mit Gürtel, 1 Einschubtasche mit Reißverschluss und 1 aufgesetzte Tasche vorne, 2 aufgesetzte Beintaschen, 2 Gesäßtaschen mit Reißverschluss, abgedeckter Reißverschluss am Hosenlatz, Verstellbänder am Beinabschluss

Material: 100 % Baumwolle/Cotton

Größen/Sizes: XS, S, M, L, XL, XXL

**Bermuda, „Eagle1“**

solid bermuda-pants, Pure Trash, made of canvas material with belt, 1 front slash pocket with zipper, 1 external front pocket, 2 cargo pockets, 2 back pockets with zipper, covered zipper fly, drawstring leg ties



alle Teile mit  
Pure Trash-Flaschenöffner





**01424A**  
schwarz-stonewashed/black-stonewashed



**01424D**  
combat-camo



**01424K**  
night-camo



**Bermuda, „Nighthawk“**

2 Einschubtaschen und eine kleine Zusatztasche vorne, 2 Gesäß- und 2 seittl. Beintaschen mit Druckknöpfen, doppelter Hintern, abgedeckter RV am Hosenlatz, Verstellbänder in der Taille und am Beinabschluss  
Material: 100 % Baumwolle/Cotton

Größen/Sizes: S, M, L, XL, XXL, XXXL

**Bermuda, „Nighthawk“**

2 slanted pockets and a small front accessory pocket, 2 hip pockets, 2 leg pouches with buttons, reinforced seat, covered zipper fly, adjustable waist tabs and drawstring ankle ties



**01443B**  
oliv-stonewashed/OD green-stonewashed



**01443A**  
schwarz-stonewashed/  
black-stonewashed



**01443L**  
sand

**Bermuda, „Spirit“**

2 Einschubtaschen vorne, 2 Gesäßtaschen mit Knöpfe, 2 seittl. Beintaschen davon eine mit Knöpfen und eine mit RV, doppelter Hintern, abgedeckter RV am Hosenlatz, Verstellbänder in der Taille

Material: 100 % Baumwolle/Cotton

Größen/Sizes: S, M, L, XL, XXL, XXXL

**Bermuda, „Spirit“**

2 thrust- in-pocket at the front, 2 hip pockets with buttons, 2 side cargo pockets with buttons and zipper, reinforced seat, covered zipper at the trousers bottom, adjustable waist tabs





**01502B**  
oliv/OD green  
Größen/Sizes: S, M, L, XL, XXL, XXXL



**01502F**  
khaki



**01502A**  
schwarz/black  
Größen/Sizes: S, M, L, XL, XXL, XXXL



**01502T**  
woodland  
Größen/Sizes: XS, S, M, L, XL, XXL



**01502U**  
urban



**01502V**  
flecktarn/BW camo



**01502W**  
6 Farben desert/6 colour desert



**01502X**  
skyblue



**01502Y**  
BW tropentarn/  
BW tropical camo



**01502Z**  
3 Farben desert/  
3 colour desert



**US BDU Bermuda**

2 seittl. Einschubtaschen, 2 Gesäß-Pattentaschen,  
2 seittl. aufgesetzte Bein-Pattentaschen,  
verstellbare Taillenweite

Material: 65 % Polyester, 35 % Baumwolle/Cotton

Größen/Sizes: S, M, L, XL, XXL

**US BDU bermuda**

2 front slash pockets, 2 back pockets, 2 cargo pockets,  
adjustable waist tabs



01583Z

3 Farben desert-stonewashed/  
3 colour desert-stonewashed

Stonewashed



01583T

woodland-stonewashed



01583B

oliv-stonewashed/  
OD green-stonewashed

**US Cargohose**

Modische 3/4 US Cargo Hose! RIP STOP,  
2 seittl. Einschubtaschen, 2 Gesäß-Pattentaschen,  
2 seittl. aufgesetzte Bein-Pattentaschen, Reißverschluss  
am Hosenschlitz

Material: 100 % Baumwolle/Cotton

Größen/Sizes: XS, S, M, L, XL, XXL

**US cargo pants**

stylish 3/4 length US cargo pants, rip stop, 2 front slash  
pockets, 2 back pockets, 2 cargo pockets, zipper fly



# Hosen



01612B

oliv-stonewashed/OD green-stonewashed



01612K

combat camo-stonewashed



01612Z

3 Farben desert-stonewashed/  
3 colour desert-stonewashed



01612T

woodland-stonewashed



alle Teile mit  
Pure Trash-Flaschenöffner

**-VINTAGE-**



## Cargohose PT, „Pilot“

robuste Cargohose mit Gürtel, aus Canvasmaterial, 2 seitt. Einschubtaschen, 1 Balgtasche mit Reißverschluss am linken Bein, 1 Schubtasche mit Reißverschluss und 1 aufgesetzte Tasche mit Druckknöpfe am rechten Bein, 2 Gesäßtaschen mit Reißverschluss, Beinweite verstellbar durch Reißverschluss

Material: 100 % Baumwolle/Cotton

Größen/Sizes: XS, S, M, L, XL, XXL

## Cargo pants PT, „Pilot“

solid cargo pants with belt, made of canvas, with 2 front slash pockets, 1 bag pocket with zipper on the left, 1 batch pocket with zipper on the right, 1 cargo pocket with snaps on the right, 2 back pockets with zipper, adjustable leg width by zipper







**01642M**  
 grau camo-stonewashed/  
 grey camo-stonewashed



**01642A**  
 schwarz-stonewashed/black-stonewashed  
 Größen/Sizes: S, M, L, XL, XXL



**01642F**  
 khaki-stonewashed  
 Größen/Sizes: XS, S, M, L



**01642T**  
 woodland-stonewashed  
 Größen/Sizes: XS, S, M, L, XL



alle Teile mit  
 Pure Trash-Flaschenöffner



**Survivalhose PT, „Vintage“**

2 seitl. Einschubtaschen, 1 aufgesetzte Beintasche mit Druckknöpfe rechts und auf der linken Beinseite eine Einschubtasche mit aufgesetzter Handytasche, 1 aufgesetzte Tasche am linken Bein unten mit Reißverschluss und Stiftehalter, Taillenweite und Beinabschluss verstellbar, abgedeckter Reißverschluss am Hosenlatz

Material: 100 % Baumwolle/Cotton

Größen/Sizes: XS, S, M, L, XL, XXL

**Survival pants PT, „Vintage“**

2 front slash pockets, 1 cargo pocket on the right with snaps and one batch pocket with an inbuilt cell-phone pocket, another cargo pocket on the left below with zipper and pen pocket, adjustable waist tabs, drawstring ankle ties, covered zipper fly





**01652K**  
combat camo



**01652A**  
schwarz/black



**01652B**  
oliv/OD green



**01652L**  
sandcamo  
Größen/Sizes: XS, S, M, L, XL, XXL



**01652T**  
woodland  
Größen/Sizes: XS, S, M, L, XL, XXL



**Cargohose PT, „Defense“**

Modische Cargo-Hose von Pure Trash, 2 Schubtaschen, 4 seitlich aufgesetzte Beintaschen vorne, die 2 aufgesetzten Gesäßtaschen haben Druckknöpfe, auf der linken oberen Tasche sind 2 Stifthalter und auf der rechten unteren Tasche 2 Schlaufen aufgenäht, geknöpfter Hosenlatz, Beinabschlusskordel

Material: 100 % Baumwolle/Cotton

Größen/Sizes: XS, S, M, L, XL, XXL, XXXL

**Cargo pants PT, „Defense“**

stylish cargo pants by Pure Trash, 2 back pockets, 4 cargo pockets on the front, 2 back pockets with snaps, left pocket on top with 2 pen pockets, right pocket below with sewed on clews, snapped fly, drawstring ankle ties

**VINTAGE**

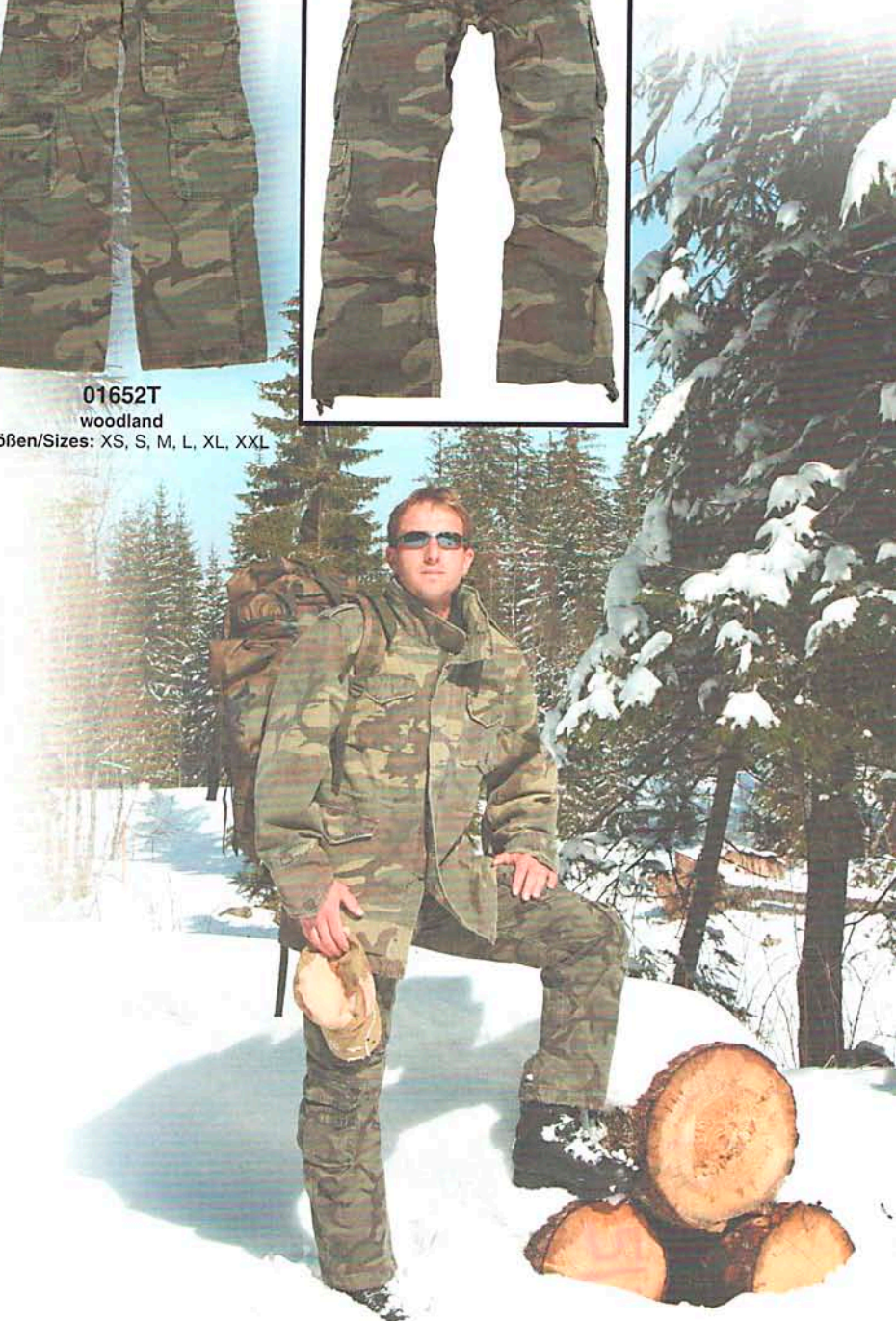



01703F  
khaki



01703A  
schwarz/black

01703B  
oliv/OD green

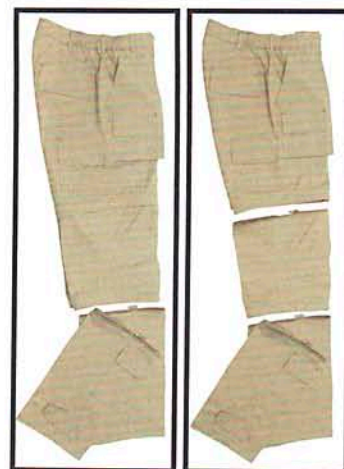

doppelt abzippbare Beine!

**Multifunktion-Hose, Microfaser**

doppelt abzippbare Beine, als Bermuda oder 3/4-Hose tragbar, mit div. Taschen, teils mit Klettverschluss, elastischer Bund mit Gürtelschlaufen, Klettflasche am Beinabschluss

Material: 70 % Baumwolle/Cotton, 30 % Nylon

Größen/Sizes: S, M, L, XL, XXL

**Multifunctional pants, microfiber**

double zipp-off legs, wearable as bermuda or 3/4-pants, with various pockets, partly with velcro, elastic band with belt loops, velcroclew at leg-end



passende Hemden, Seite 51  
Artikel-Nr.: 02303

passende Westen, Seite 75  
Artikel-Nr.: 04303





01763G

hunter-braun/hunter-brown



01763B

oliv/OD green

Größen/Sizes:

S, M, L, XL, XXL, XXXL, 4XL

passende Jacken, Seite 58  
Artikel-Nr.: 03443

**Outdoorhose, Poly Tricot**

wasserdicht, atmungsaktiv, geräuscharm, Gummibund, Zugband mit Kordelstopper an Taille, doppelte Knie, doppelter Hintern, 2 seitl. Einschubtaschen, 2 schräg aufgesetzte Bein-Taschen mit Druckknopf, abgedeckter Reißverschluss an Beinenden, Netzfutter, verstellbarer Beinabschluss per Klett

Material: 100 % Polyester

Größen/Sizes: S, M, L, XL, XXL, XXXL, 4XL, 5XL

**Outdoor pants, Poly Tricot**

waterproof, breathable, low-noise, elastic waistband, drawstring with cord stopper waist, reinforced knees and bottom, 2 side pockets, 2 leg pockets with buttons, covered zipper at leg bottom, mesh lining, elastic leg bottom with velcro





01463C

**BW Bermuda, Jeans**

blau-stonewashed, 2 seittl. Einschubtaschen, Gesäßtasche, 2 seittl. aufgesetzte Bein-Pattentaschen, aus Denim

Material: 100 % Baumwolle/Cotton

Größen/Sizes: XS, S, M, L, XL

**BW bermuda, jeans**

blue-stonewashed, 2 front slash pockets, back pocket, 2 cargo pockets, Denim

01123C

**BW Feldhose, Jeans**

blau-stonewashed, Nachbau der BW Moleskinhose in originalem Schnitt, aus Denim-Material, 2 seittl. Einschubtaschen, Gesäßtasche, 2 seittl. aufgesetzte Bein-Pattentaschen.

Material: 100 % Baumwolle/Cotton

Größen/Sizes: 6, 7, 8

**BW pants, jeans**

blue-stonewashed, remake of the BW field pants in original cut, Denim, with 2 button-down cargo pockets, 1 back pocket, 2 front slash pockets

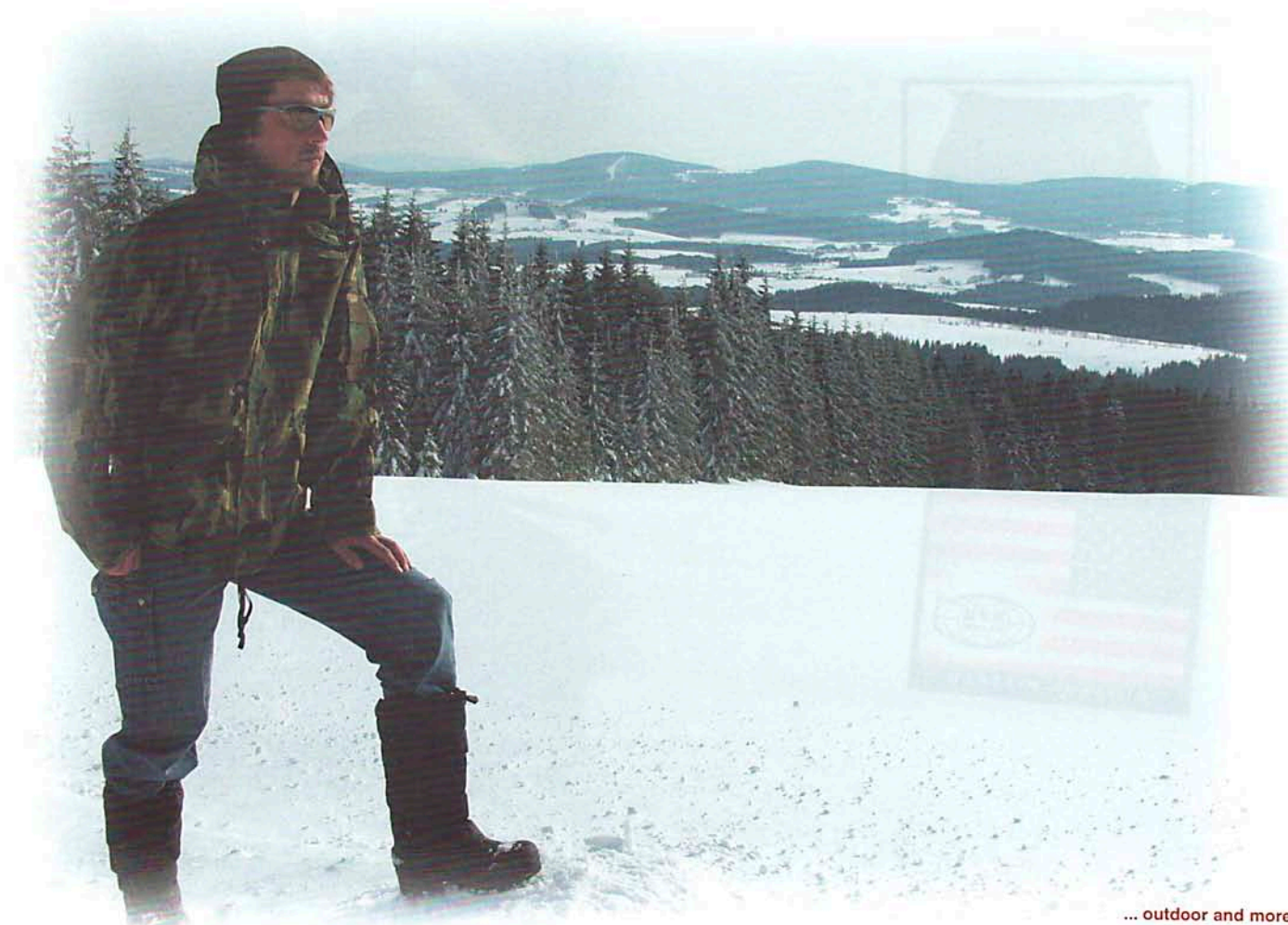



01853T  
woodland



01853A  
schwarz/black



01853U  
urban

**US BDU Hose, Damen**

US ARMY Hose in modischer Damenform,  
2 seitr. Einschubtaschen, 2 Gesäß-Pattentaschen,  
2 seitr. aufgesetzte Bein-Pattentaschen,  
Bandzug am Beinende, verstellbare Tailleweite,  
geknöpfter Hosenschlitz

Material: 65 % Polyester, 35 % Baumwolle/Cotton

Größen/Sizes: XS/34, S/36, M/38, L/40, XL/42, XXL/44

**US BDU ladies pants**

US ARMY pants in stylish ladyform,  
2 side slidepockets, 2 back flap pockets,  
2 side put-on leg flap pockets, drawstring at leg-end,  
adjustable waist tab, button fly



Sehr robust durch Verstärkung  
am Knie und Hintern!



**-VINTAGE-**



01883K

combat camo-stonewashed



01883A

schwarz-stonewashed/black-stonewashed



01883L

sand camo-stonewashed



01883M

grau camo-stonewashed/  
grey camo-stonewashed



01883T

woodland-stonewashed



alle Teile mit  
Pure Trash-Flaschenöffner



**US Cargo Hose, „Combat“, Damen**

modische Damen-Cargo-Hose mit Gürtel,  
2 seittl. Einschubtaschen mit Reißverschluss,  
4 Beintaschen mit Reißverschluss,  
2 aufgesetzte Gesäßtaschen mit Knöpfe,  
Beinweite verstellbar durch Reißverschluss,  
abgedeckter Reißverschluss am Hosenlatz

Material: 100 % Baumwolle/Cotton  
Größen/Sizes: XS/34, S/36, M/38, L/40, XL/42, XXL/44

**US cargo pants, „Combat“, ladies**

stylish ladies cargo pants with belt,  
2 front slash pockets with zipper,  
4 leg pockets with zipper,  
2 back pockets with push buttons,  
width-adjustable leg via zipper, covered zipper fly





01983B

oliv-stonewashed/OD green-stonewashed



alle Teile mit  
Pure Trash-Flaschenöffner

•VINTAGE•

**Damenrock, „Cargo“**

modischer Damenrock von Pure Trash, abgedeckter Front-Reißverschluss mit Knopfabschluss, Gehschlitz vorne, 2 Schubtaschen vorne, 4 aufgesetzte Fronttaschen mit Druckknopf, 1 Handytasche, 2 Gesäßtaschen mit Reißverschluss

Material: 100 % Baumwolle/Cotton  
Größen/Sizes: XXS/32, XS/34, S/36, M/38, L/40, XL/42

**Skirt, „Cargo“**

stylish skirt by Pure Trash, covered front zipper, walking slit in front, 2 patch pockets, 4 pockets with snaps, 1 cell-phone pocket, 2 back pockets with zipper



01983F

khaki-stonewashed



01983L

sand camo-stonewashed



01983T

woodland-stonewashed

Größen/Sizes:

XXS/32, XS/34, S/36, M/38, L/40



01983Z

grau camo-stonewashed/

grey camo-stonewashed

Stonewashed

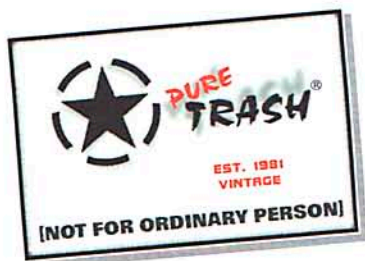





**02303F**  
khaki



**02303A**  
schwarz/black



**02303B**  
oliv/OD green

**Outdoor Hemd**

kurzarm, Microfaser, 2 Brusttaschen  
 Material: 70 % Baumwolle/Cotton, 30 % Nylon  
 Größen/Sizes: S, M, L, XL, XXL  
**Outdoor shirt**  
 short sleeves, microfibre, 2 breast-pockets



**02712A**  
US Hemd, kurzarm

schwarz, Freizeithemd mit Schulterklappen und Brusttaschen  
 Material: 65 % Polyester, 35 % Baumwolle/Cotton  
 Größen/Sizes: S, M, L, XL, XXL  
**US Shirt, short sleeves**  
 black, casual shirt with epaulettes and breast-pockets



**02752A**  
US Hemd, langarm

schwarz, Freizeithemd mit Schulterklappen und Brusttaschen  
 Material: 65 % Polyester, 35 % Baumwolle/Cotton  
 Größen/Sizes: S, M, L, XL, XXL  
**US Shirt, long sleeves**  
 black, casual shirt with epaulettes and breast-pockets

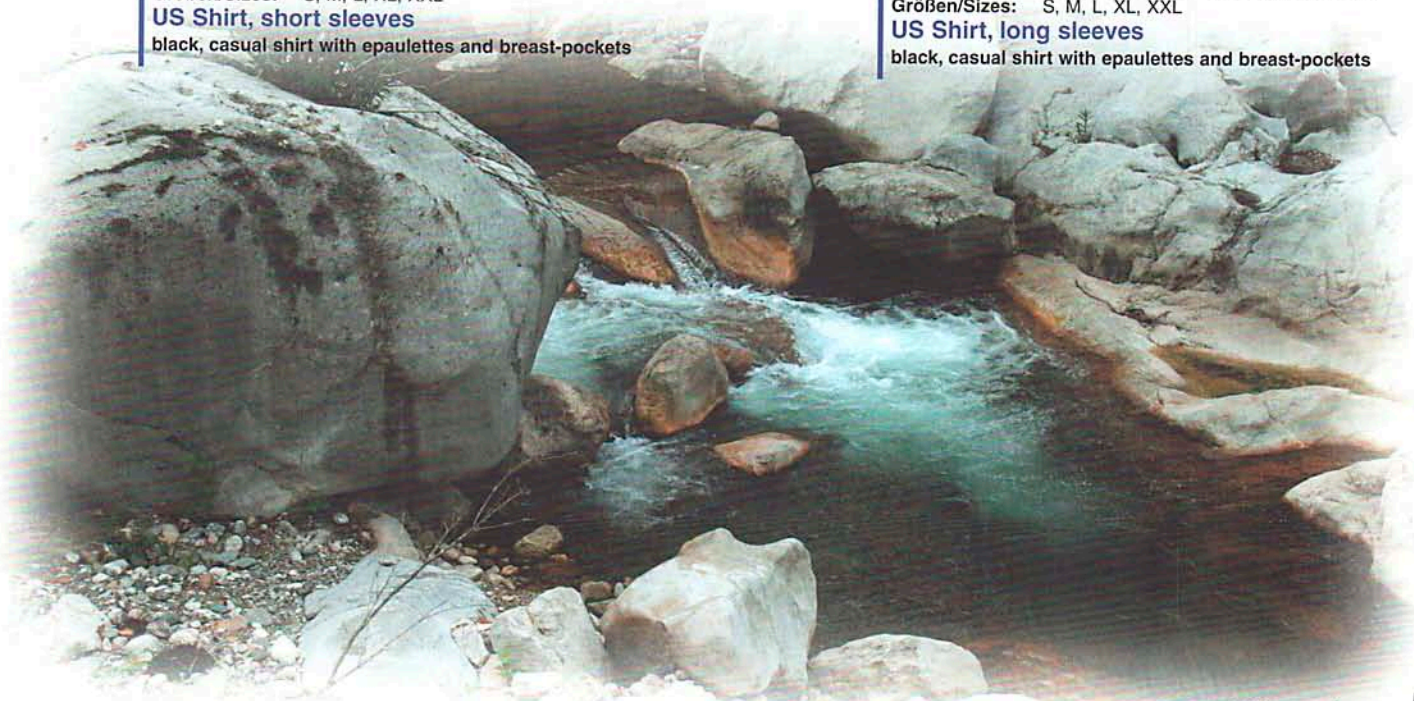



02601Q  
AT-digital

## US Combat Hemd

Armprotektoren abnehmbar,  
Ärmeltaschen mit RV und Klettflauschpatches,  
PVC und Schaumstoff Ellbogenprotektoren abnehmbar,  
verstellbarer Ärmelabschluss per Klettband  
Material: Torso/body: 100 % Polyester Spandex  
Ärmel, Kragen und Schulter/sleeves, collar and shoulders:  
60 % Baumwolle/Cotton, 40 % Polyester

Größen/Sizes: S, M, L, XL, XXL

## US combat shirt

with arm pad, sleeves with zip and velcro patches,  
PVC and padding elbow protectors, detachable,  
adjustable velcro wrist cuffs



02601A  
schwarz/black



02601B  
oliv/OD green





**03072A**  
schwarz/black



**03072B**  
oliv/OD green

**US Feldjacke M65**

Top-US Feldjacke mit Baumwollfutter und ausknöpfbarem Zweitfutter, 4 aufgesetzten Pattentaschen, im Kragen eingearbeitete Kapuze (Reißverschluss), Kordelzug am Saum und Taille (weitenverstellbar), mit Klettverschluss für weitenverstellbare Ärmel, Mod.

Obermaterial/Shell: 65 % Polyester, 35 % Baumwolle/Cotton

Innenfutter/Lining: 100 % Baumwolle/Cotton

Zweitfutter/Inner Lining: 100 % Polyester

Größen/Sizes: S, M, L, XL, XXL, XXXL, 4XL

**US field jacket M65**

top US field jacket with cotton lining and removable second lining, 4 put-on flap pockets, hood inside collar (zipper), drawstring on the seam and waist (adjustable), with velcro to adjust the sleeves



**03092B**  
oliv/OD green



**03092A**  
schwarz/black

**Futter für US Feldjacke M65**

Rip-Stop

Material: 100 % Nylon

Größen/Sizes: S, M, L, XL, XXL

**Lining for US field jacket M65**

rip stop

**-VINTAGE-**

03112T

## Feldjacke, „Defense“

woodland, modische M65 Feldjacke, austrennbares Teddyfutter mit Reißverschluss, 4 aufgesetzte Pattentaschen mit Druckknopf, im Kragen eingearbeitete Kapuze (Reißverschluss), Kordelzug an der Taille, weitenverstellbare Ärmel mit Klettverschluss

Außenmaterial/Outside: 100 % Baumwolle/Cotton

Innenfutter/Lining: 80 % Acryl, 20 % Polyester

Größen/Sizes: S, M, L, XL, XXL

## Field jacket, „Defense“

woodland, stylish M65 fieldjacket by Pure Trash, detachable teddy-lining with zipper, 4 put-on flap pockets, hood inside collar (zipper), drawstring in waist (adjustable), velcro for adjustable sleeves





03401R  
coyote tan

WATERPROOF - WINDPROOF - BREATHABLE

**US Soft Shell Jacke, „Level 5“**

PCU- Protective Combat Uniform, wasserdicht, winddicht, atmungsaktiv, Ärmeltaschen mit Klettverschluss und Klettflauschpatches, verstellbarer Ärmelabschluss per Klettband, 2 Einschubtaschen auf Brust mit RV, Bund mit elastischem Kordelzug, Unterarm-RV zur Belüftung, div. Klettflauschpatches, integrierte Kapuze am Kragen, Front RV mit hinterlegter Windleiste

Außenmaterial/Outside: 98 % Nylon, 2 % Spandex

Größen/Sizes: S, M, L, XL, XXL

**US soft shell jacket, „Level 5“**

PCU- protective combat uniform, waterproof, windproof, breathable, sleeves with velcro closure and velcro patches, adjustable velcro wrist cuffs, 2 cargo breast pockets with zipper, waistband with elastic drawstring, zippered arm for ventilation, diff. velcro patches, concealed hood in collar, front zip with wind selvage



03401A  
schwarz/black



03401B  
oliv/OD green

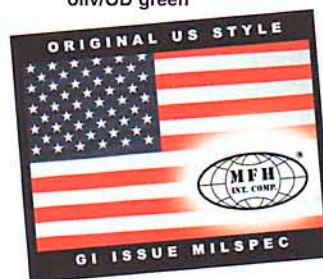

03411B  
oliv/OD green

WATERPROOF - WINDPROOF - BREATHABLE

**Soft Shell Jacke, „High Defence“**

wasserdicht, winddicht, atmungsaktiv, 2 Ärmeltaschen mit RV und Klettflauschpatches, verstellbarer Ärmelabschluss per Klettband, Ärmelwindfang, 1 Einschubtasche auf Brust mit RV, 2 geräumige Fronteinschubtaschen mit RV, Unterarm-RV zur Belüftung, 2 Seiten RV, Kordelzug an Kragen, wasserdichter RV an vorderer Mitte, Front- und Ärmeltaschen, Ellbogenbesätze, 1 Innentasche mit aufgesetzter Handytasche, 2 Klettaufnahmen für Rang und Namen

Außenmaterial/Outside: 94 % Polyester, 6 % Elasthan

Futter/Lining: 100 % Polyester-Fleece

Größen/Sizes: S, M, L, XL, XXL, XXXL

**Soft shell jacket, „High Defence“**

waterproof, windproof, breathable, 2 sleeve pockets with velcro closure and velcro patches, adjustable velcro wrist cuffs with velcro, wind selvage, 1 zipped thrust in pocket in the front, 2 cargo breast pockets with zipper, forearm zipper for ventilation, 2 side zippers, cord at the collar, waterproof zipper in the front middle, front and sleeve pockets, reinforced elbows, 1 inner pocket with handy pocket, 2 velcro for rank insignia



03411A  
schwarz/black

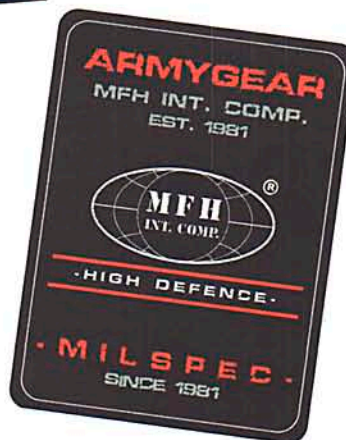

WATERPROOF - WINDPROOF - BREATHABLE

03421A

**Soft Shell Jacke, „Protect“**

schwarz, wasserdicht, winddicht, atmungsaktiv,  
 Bund mit elastischem Kordelzug, 4 geräumige Einschubtaschen auf der  
 Front und 2 Ärmeltaschen mit wasserfesten RV,  
 2 Innen- und eine Rückentasche mit RV, weitenverstellbare Ärmel mit  
 Klettverschluss, Unterarm-RV zur Belüftung, 2 Seitenschlitze mit RV  
 Außenmaterial/Outside: 94 % Polyester, 6 % Elasthan/Elastane  
 Futter/Lining: 100 % Polyester-Fleece  
 Wassersäule/water column: bis/up to 8000 mm  
 Größen/Sizes: S, M, L, XL, XXL, XXXL

**Soft shell jacket, „Protect“**

black, waterproof, windproof, breathable,  
 waistband with elastic drawstring, 4 spacious pockets cargo in front and  
 2 sleeves pockets with waterproof zipper, 2 inner and 1 pocket on the  
 back with zipper, adjustable cuffs with velcro,  
 zippered arm for ventilation, 2 side vents with zipper





03431A  
schwarz/black

**Soft Shell Jacke, „Flying“**

wasserdicht, winddicht, atmungsaktiv, Bund mit elastischem Kordelzug, wasserfeste Reißverschlüsse an den 2 geräumigen Einschubtaschen, Ärmeltasche und Front, Einschubtasche Brust links mit RV, weitenverstellbare Ärmel mit Klettverschluss

Außenmaterial/Outside: 94 % Polyester, 6 % Elasthan/Elastane

Futter/Lining: 100 % Polyester-Fleece

Wassersäule/water column: bis/up to 8000 mm

Größen/Sizes: S, M, L, XL, XXL, XXXL

**Soft shell jacket, „Flying“**

waterproof, windproof, breathable, waistband with elastic drawstring, waterproof zippers at the 2 spacious cargo pockets, sleeve pocket and front, chest slanted pockets to the left with zipper, adjustable cuffs with velcro



03431H  
oliv-schwarz/OD green-black



03431B  
oliv/OD green

WATERPROOF - WINDPROOF - BREATHABLE



03451A

**Soft Shell Jacke, „Lusen“**

schwarz, Bund mit elastischem Kordelzug, 2 seitliche Einschubtaschen mit RV, Einschubtasche Brust links mit RV

Außenmaterial/Outside: 94 % Polyester, 6 % Elasthan/Elastane

Futter/Lining: 100 % Polyester-Fleece

Größen/Sizes: S, M, L, XL, XXL, XXXL

**Soft shell jacket, „Lusen“**

black, waistband with elastic cord, 2 side thrust in pockets with zipper, thrust in pocket, breast left with zipper



passende Hosen, Seite 46  
 Artikel-Nr.: 01763



**03443G**

hunter-braun/hunter-brown  
 Größen/Sizes: S, M, L, XL, XXL, XXXL



**03443B**

oliv/OD green

### Outdoorjacke, „Poly Tricot“

atmungsaktiv, wasserdicht, geräuscharm, 2 aufgesetzte Taschen mit Druckknopf, 2 Einschubtaschen mit Druckknopf auf Brust, 1 große Rückentasche mit 3 Reißverschlüssen zum Öffnen und gummiertem Futter, abnehmbare Kapuze mit Kordelzug im Kragen, abgedeckter Frontreißverschluss, Netzfutter im oberem Rückenbereich, Rückenfalte

Material: 100 % Polyester

Größen/Sizes: S, M, L, XL, XXL, XXXL, 4XL

### Outdoorjacket, „Poly Tricot“

waterproof, breathable, silence material, 2 patch pockets with press buttons, 2 thrust-in-pockets with press buttons at the breast, 1 big bag pocket with 3 zippers for opening and ribberized lining, removable hood with cord in the collar, covered frontal zipper, mesh lining in the upper back side, back box pleat

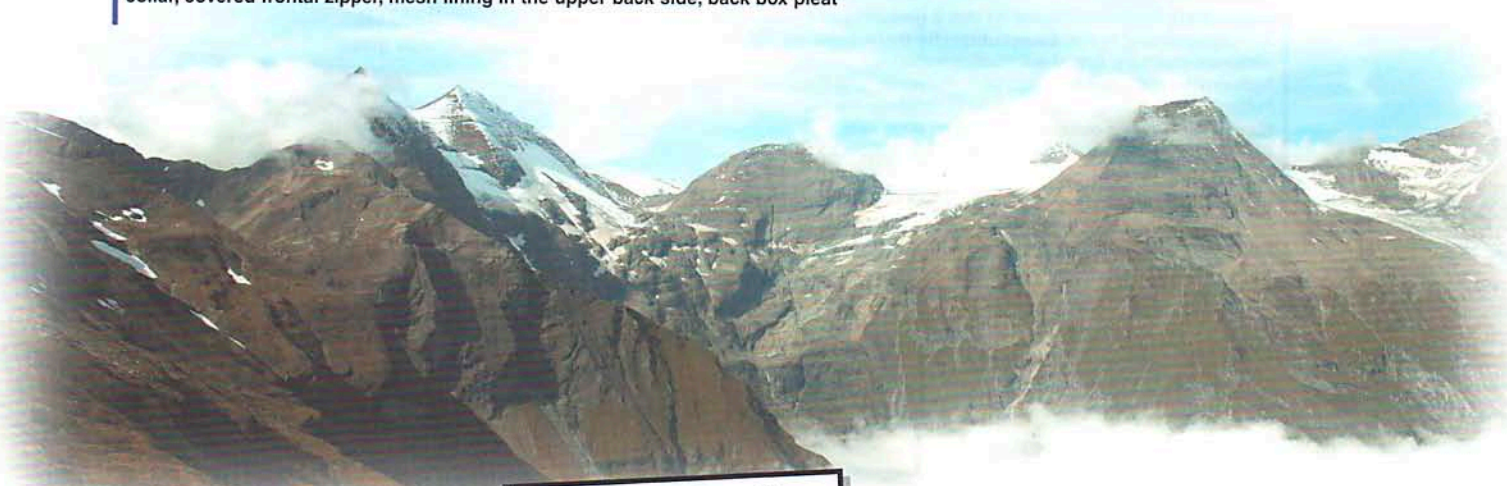

passende Hosen, Seite 29  
 Artikel-Nr.: 01352



**03482T**  
 woodland



**03482A**  
 schwarz/black



**03482B**  
 oliv/OD green

### Kommandojacke, „Smock“

Rip Stop, starker 2-Wege Frontreißverschluss mit Knopfleiste und Klettverschluss, 4 Front- und 2 Seitentaschen knöpfbar, 2 Einschubtaschen mit RV, 1 Rückentasche geknöpft und seitlichen RV, Kapuze mit Stelldraht, 1 Rückeninnentasche, 2 Brustinnentaschen mit RV, 2 Kletttaufnahmen auf Brust, Kordelzug an Bund und Taille, herausnehmbare Polsterung an den Unterarmen, Ärmelweite per Klett verstellbar

Material: 65 % Polyester, 35 % Baumwolle/Cotton

Größen/Sizes: S, M, L, XL, XXL, 3XL

### Commandojacket, „Smock“

strong 2-way front zip with buttons and velcro, 4 front- and 2 side pockets, buttoned, 2 cargo pockets with zip, 1 pocket on the back side, with buttons and side zip, wired hood, 1 back pocket inside, 2 breast inside pockets with zip, 2 loop patch the breast, drawstrings at the waistband, removable foam pads at the armpits, adjustable velcro cuffs





**03552A**  
schwarz/black  
Größen/Sizes: XS, S, M, L, XL, XXL, XXXL

**03553A**  
schwarz/black  
Größen/Sizes: 4XL, 5XL



**03552G**  
alphablau/blue  
Größen/Sizes: XS, S, M, L, XL, XXL



**03552B**  
oliv/OD green  
Größen/Sizes: XS, S, M, L, XL, XXL

**US Pilotenjacke MA1, Mod.**

Die klassische US-Wende-Pilotenjacke MA1.  
2 geräumige Schubtaschen mit Druckknopfverschluss,  
Armbüro, Strickbund am Kragen und Bund  
Obermaterial/Outside: 100 % Nylon  
Innenmaterial/Lining: 100 % Polyester  
Füllung/Filling: 100 % Polyester

**US flight jacket MA1, Mod.**

The classic US-pilot-reversible-jacket MA1,  
2 spacious side pockets with snaps, zippered utility  
pocket, knit waistband on collar and seam



**03560A**

**US Pilotenjacke MA1, Mod.**

schwarz, mit „SECURITY“ bestickt  
Obermaterial/Outside: 100 % Nylon  
Innenmaterial/Lining: 100 % Polyester  
Füllung/Filling: 100 % Polyester  
Größen/Sizes: XS, S, M, L, XL, XXL, XXXL

**US flight jacket MA1, Mod.**

black, silver broiders „SECURITY“





03742A  
schwarz/black



**CWU-Piloten-Jacke, schwere Ausführung**  
mit Kragen, 2 aufgesetzte Pattentaschen mit Klettverschluss, Armbüro, Strickbund am Ärmel und Bund, Klettschild auf der linken Brustseite  
Obermaterial/Outside: 58 % Baumwolle/Cotton, 42 % Nylon  
Innenmaterial/Lining: 100 % Polyester  
Füllung/Filling: 100 % Polyester  
Größen/Sizes: XS, S, M, L, XL, XXL, XXXL

**US CWU flight jacket, heavy**  
with collar, 2 flap pockets with velcro, zippers utility pocket, knit waistband on sleeve and seam



03752G  
navyblau/navyblue

**CWU-Piloten-Jacke**  
mit Kragen, 2 aufgesetzte Pattentaschen mit Klettverschluss, Armbüro, Strickbund am Ärmel und Bund  
Obermaterial/Outside: 100 % Nylon  
Innenmaterial/Lining: 100 % Polyester  
Füllung/Filling: 100 % Polyester  
Größen/Sizes: S, M, L, XL, XXL

**US CWU flight jacket**  
with collar, 2 flap pockets with velcro, zippered utility pocket, knit waistband on sleeve and seam



03752A  
schwarz/black

Größen/Sizes: XS, S, M, L, XL, XXL, XXXL



03752B  
oliv/OD green

03753A

schwarz/black

Größen/Sizes: 4XL, 5XL





03702A

schwarz/black

Größen/Sizes: XS, S, M, L, XL, XXL, XXXL



03702B

oliv/OD green

Größen/Sizes: XS, S, M, L, XL, XXL



03722A

Polarjacke, N3B

schwarz, dick gefüttert, teilbare Kapuze per RV mit Kunstfell besetzt, geknöpfte Windabdeckleiste an Frontreißverschluss, 4 Einschubtaschen mit Druckknopf, 1 Ärmeltasche mit RV links, Kordelzug an Taille

Obermaterial/Outside: 100 % Nylon  
 Innenmaterial/Lining: 100 % Polyester  
 Füllung/Filling: 100 % Polyester  
 Größen/Sizes: S, M, L, XL, XXL

Polar jacket, N3B

black, thick lining, separable hood with zipper with white fake fur, wind cover strip with buttons at the front zipper, 4 thrust in pockets with press button, 1 sleeve pocket with zipper on the left, cord on the waist

**Polarjacke, N2B**

dick gefüttert, teilbare Kapuze per RV mit Kunstfell besetzt, geknöpfte Windabdeckleiste an Frontreißverschluss, 2 Einschubtaschen mit Druckknopf, 1 Ärmeltasche mit RV links, 2 Innentaschen mit Druckknopf, Strickbündchen am Saum und Ärmel

Obermaterial/Outside: 100 % Nylon  
 Innenmaterial/Lining: 100 % Polyester  
 Füllung/Filling: 100 % Polyester

**Polar jacket, N2B**

thick lining, separable hood with zipper with white fake fur, buttoned border at the front zipper, 2 thrust in pockets with press button, 1 sleeve pocket with zipper on the left, 2 inner pockets with press buttons, knitted waistband at the waist and sleeves





**03334T**  
woodland  
Größen/Sizes:  
S, M, L, XL, XXL, XXXL



**03334A**  
schwarz/black



**03334B**  
oliv/OD green  
Größen/Sizes:  
S, M, L, XL, XXL, XXXL, 4XL

passende Hosen, Seite 30, 31  
Artikel-Nr.: 01334

**US BDU Feldjacke, Rip Stop**

klassische US Army Feld-Jacke,  
4 aufgesetzte Brust-Pattentaschen, verstellbare Taillenweite,  
doppelte Ellbogen, Ärmelbund mit Knöpfe verstellbar,  
Ärmeltasche für Stifte

Material: 100 % Baumwolle/Cotton

Größen/Sizes: S, M, L, XL, XXL

**US BDU field jacket, rip stop**

classic US army fieldjacket, 4 breast flap pockets,  
adjustable waist width, reinforced elbow,  
armseam adjustable with buttons, armpocket for pens



**03374C**  
tiger stripe



**03374B**  
oliv/OD green



**03375B**  
oliv-stonewashed/  
OD green-stonewashed



**03375C**  
tiger stripe-stonewashed

Stonewashed

**US Feldjacke, „Vietnam“, Rip Stop**

Vietnam-Style, 2 schräg aufgesetzte Brusttaschen  
mit Knöpfen, 2 aufgesetzte Seitentaschen mit Knöpfen,  
1 Brust- und 1 Ärmelpatch

Material: 100 % Baumwolle/Cotton

Größen/Sizes: S, M, L, XL, XXL

**US field jacket „Vietnam“, rip stop**

Vietnam-Style, 2 angular put-on side pockets with buttons,  
2 put-on side pockets with buttons, 1 chest- and armpatch

passende Hosen, Seite 34  
Artikel-Nr.: 01374, 01375





03383Q  
AT-digital



03383K  
night-camo



03383L  
vegetato



03383M  
vegetato desert



03383R  
coyote tan



03383S  
digital-woodland



03383V  
flecktarn/BW camo

#### US Feldjacke, ACU

ACU ARMY COMBAT UNIFORM Jacke, Rip Stop, neues Basismodell der US Army für alle Regionen, 2 schräge Brusttaschen mit Klettverschluss, Ellbogenbesatz kann durch Polster verstärkt werden, 2 Schultertaschen mit Klett für Abzeichen, Stehkragen mit Klett, Frontreißverschluss

Material: 100 % Baumwolle/Cotton

Größen/Sizes: S, M, L, XL, XXL, XXXL

#### US field jacket, ACU

The ACU ARMY COMBAT UNIFORM Jacket, Rip Stop, the new basic model of the US Army for all regions, 2 angular breast pockets with velcro, elbow can be reinforced by pads, 2 shoulder pockets with velcro for emblem, standing collar with velcro, front zipper





**03903A**  
schwarz/black



**03903G**  
blau/blue  
Größen/Sizes: S, M, L, XL, XXL, XXXL

**Blouson, „Security“**

praktischer Funktions-Einsatz-Blouson, „SECURITY“, abtrennbare Ärmel mit Reißverschluss, Innenfutter mit Tasche und Handytasche, herausnehmbar, Brust- und Rückenpatch abnehmbar mit Reißverschluss, Lieferung mit je einem bedrucktem (Security) und unbedrucktem Brust- und Rückenpatch

Außenmaterial/Outside: 100 % Nylon  
Innenmaterial/Lining: 100 % Polyester  
Futter/Filling: 100 % Polyester  
Größen/Sizes: S, M, L, XL, XXL, XXXL, 4XL

**Blouson, „Security“**

funktional-operation-blouson, „SECURITY“, detachable sleeves with zipper, inside lining with pocket and cellphone pocket detachable, chest- and backpatch detachable with zipper, delivery with one printed and one unprinted for chest- and for backpatches



**06903A**

**Parka, „Security“**

schwarz, Einsatz-Parka, „SECURITY“, mit Kapuze, 2 abgedeckte Einschubtaschen mit Klettverschluss, Innenfutter mit Tasche und Handytasche, Brust- und Rückenpatch abnehmbar, mit Reißverschluss, Lieferung mit je einem bedruckt und unbedrucktem Brust- und Rückenpatch

Außenmaterial/Outside: 100 % Nylon  
Innenmaterial/Lining: 100 % Polyester  
Futter/Filling: 100 % Polyester  
Größen/Sizes: S, M, L, XL, XXL, XXXL, 4XL

**Parka, „Security“**

black, assignment-parka, „SECURITY“, with hood, 2 covered slide slash pockets with velcro, inside lining with pocket and cellphone pocket, detachable chest- and backpatch, with zipper, delivery with one printed and one unprinted chest- and backpatch each





03913A

**Jacke, „Security“**

schwarz, wasserdicht, antistatisch, herausnehmbare Fleece-Innenjacke mit div. Taschen, abtrennbare Ärmel mit Reißverschluss bei Außen- und Innenjacke, Rückenteil mit Netzeinsatz, Kordelzug an Taille, eingearbeitete Kapuze im Kragen, 2 abgedeckte Einschubtaschen mit Reißverschluss auf Brust, 6 aufgesetzte Fronttaschen mit Druckknopf bzw. Klett, 2 Seitenschlitze mit Reißverschluss, 1 Schubtasche mit Reißverschluss auf der linken Brustseite, Klettverschluß für weitenverstellbare Ärmel, geknöpfte Windabdeckleiste am Front-Reißverschluss

Außenmaterial/Outside: 100 % Polyester  
 Innenmaterial/Lining: 100 % Polyester  
 Futter/Filling: 100 % Polyester  
 Größen/Sizes: S, M, L, XL, XXL, XXXL, 4XL

**Jacket, „Security“**

black, waterproof, antistatic, removable fleece jacket with detachable sleeves with zipper at the inner and outer jacket, back panel with net, cord at the waist, hood in the collar, 2 covered thrust-in-pockets with zipper at the breast, 6 front flap patch pockets with buttons resp. velcro, 2 side slits with zipper, 1 trust in pocket with zipper at the left breast, velcro for adjustable sleeves, buttoned covered molding at the front-zipper



WATERPROOF - WINDPROOF - BREATHABLE



03791A

**USMC Combat Jacke**

schwarz, wasserdicht, winddicht, atmungsaktiv, 3 geräumige Einschubtaschen auf der Front und 1 Ärmeltasche mit RV, Ellbogenverstärkung, verstärkter Kragen mit integriertem Kopfschutz, alle RV wasserfest, Aufnahme für Rangabzeichen

Außenmaterial/Outside: 100 % Nylon  
 Futter/Filling: 100 % Polyester-Fleece  
 Größen/Sizes: S, M, L, XL, XXL, XXXL

**USMC combat jacket**

black, waterproof, windproof, breathable, 3 spacious pocket cargo on the front and 1 sleeve pocket with zipper, reinforced elbow parts, reinforced collar with integrated head protector, all zippers are waterproof, 1 velcro rank tab





03653A

schwarz/black

Größen/Sizes: S, M, L, XL, XXL, XXXL

**Jacke, „English Style“**

2 abgedeckte Einschubtaschen außen, 1 Innentasche, Strickbündchen am Bund und Ärmel, Karofutter, Stehkragen  
 Obermaterial/Upper: 65 % Polyester, 35 % Baumwolle/Cotton  
 Innenmaterial/Lining: 100 % Acryl  
 Größen/Sizes: S, M, L, XL, XXL

**Jacket, „English Style“**

2 covered thrust in pockets outside, 1 inner pocket, knitted waistband at the waist and sleeves, checkered lining, stand up collar



03653D

night-camo

Größen/Sizes: S, M, L, XL, XXL, XXXL



03653F

khaki



03653G

blau/blue



03663A

**Jacke, „English Style“, Winterausführung**

schwarz, gefüttert, 2 abgedeckte Einschubtaschen außen, 1 Innentasche, Strickbündchen am Bund und Ärmel, Karofutter, Stehkragen

Obermaterial/Upper: 70 % Wolle/Wool, 30 % Viskose

Innenmaterial/Lining: 100 % Acryl

Größen/Sizes: S, M, L, XL, XXL

**Jacket, „English Style“, winter**

black, 2 covered thrust in pockets outside, 1 inner pocket, knitted waistband at the waist and sleeves, checkered lining, stand-up collar





WATERPROOF - WINDPROOF - BREATHABLE



03801V  
flecktarn/BW camo



03801A  
schwarz/black



03801B  
oliv/OD green

**Fleece-Jacke, „Alpin“**

wasserdicht, winddicht, atmungsaktiv, hoher Tragekomfort, Gummizug am Bund, Kragen mit Kordelzug, 2 geräumige Einschubtaschen mit Reißverschluss, 1 Handyinnentasche mit Klettverschluss, Schulter-, Ärmelbesatz, Belüftungsschlitze mit Reißverschluss unter den Armen, Innenbrusttasche mit Reißverschluss, Hüft-, Kragenkordelzug

Material: 100 % Polyester

Größen/Sizes: XS, S, M, L, XL, XXL, XXXL

**Fleece-jacket, „Alpin“**

waterproof, windproof, breathable, very comfortable, elastic on the seam, collar with drawstring, 2 huge slidepockets with zippers, inside pocket for cellphones, shoulder and sleeve trimming, ventilation-slits with zipper under the arms, inside-breast-pocket with zipper, hip and collar drawstring

WATERPROOF - WINDPROOF - BREATHABLE



03861B  
oliv/OD green



03861A  
schwarz/black

**Fleece-Jacke, „Mountain“**

wasserdicht, winddicht, atmungsaktiv, hoher Tragekomfort, Bund mit elastischem Kordelzug, 2 Schubtaschen mit Reißverschluss, 1 Handyinnentasche mit Klettverschluss

Material: 100 % Polyester

Größen/Sizes: S, M, L, XL, XXL, XXXL

**Fleece-jacket, „Mountain“**

waterproof, windproof, breathable, very comfortable, seam with elastic drawstring, 2 huge slidepockets with zippers, inside pocket with velcro for cellphones

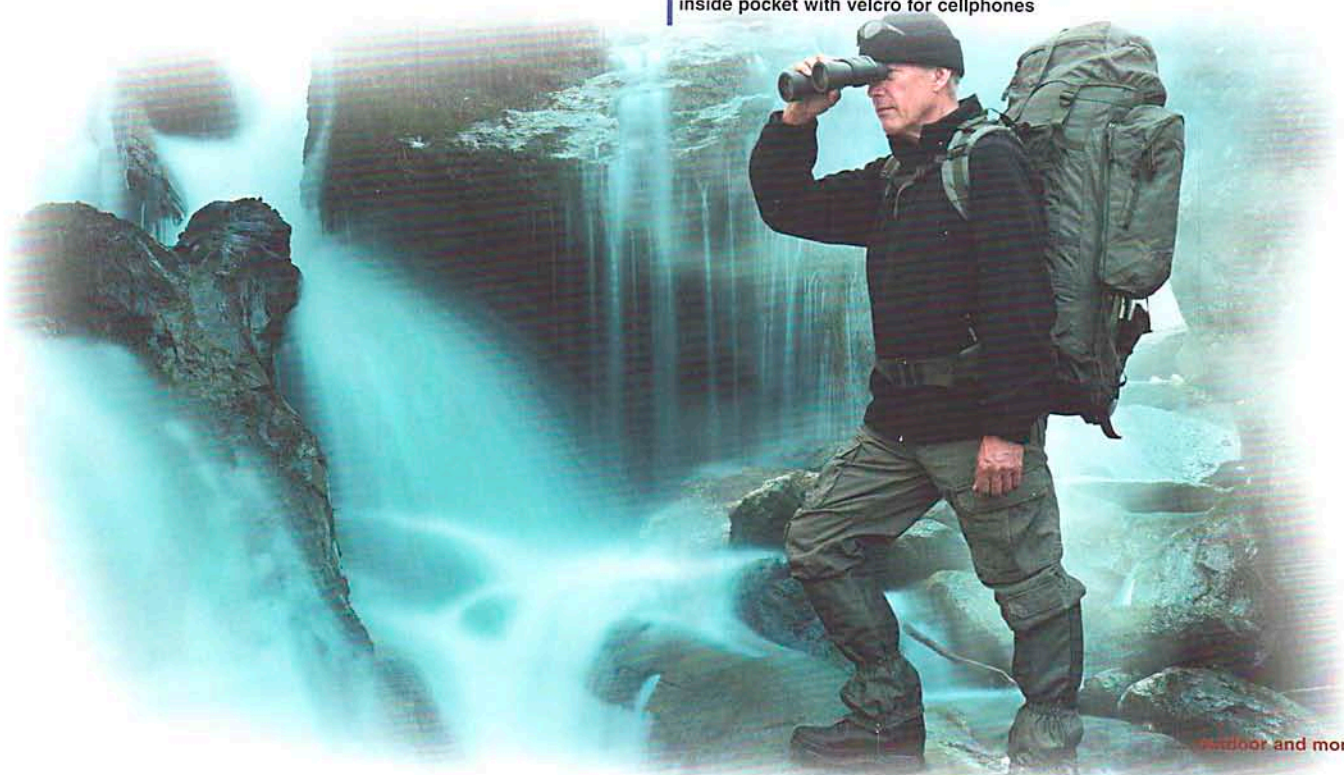

WATERPROOF - WINDPROOF - BREATHABLE

03821H

**Fleece-Jacke, „Air“**

oliv, schwarze Nylon Besätze, wasserdicht, winddicht, atmungsaktiv, Bund mit elastischem Kordelzug, 3 geräumige Einschubtaschen mit RV, weitenverstellbare Ärmel mit Klettverschluss, robuster Schulter- und Ärmelbesatz, weitenverstellbarer Kragen per Kordelzug mit integrierter Kapuze, Belüftungsschlitze mit RV unter den Armen

Außenmaterial/Outside: 100 % Polyester laminiert mit TPU

Futter/Liner: 100 % Polyester-Fleece

Besatz/Reinforcement: 100 % Nylon

Größen/Sizes: S, M, L, XL, XXL, XXXL

**Fleece-jacket, „Air“**

OD green, nylon patch black, waterproof, windproof, breathable, waistband with elastic drawstring, 3 spacious pockets cargo with zipper, adjustable cuffs with velcro, strong shoulder and sleeve border, adjustable collar with drawstring and integrated hood, zippered arm for ventilation



03871A  
schwarz/black

**Fox<sup>®</sup>**  
Outdoor

**Fleece-Jacke, „Arber“**

Reißverschluss in Jackenfarbe, Bund mit elastischem Kordelzug, 2 geräumige Schubtaschen mit Reißverschluss, 1 Handyinnentasche mit Klettverschluss

Material: 100 % Polyester

Größen/Sizes: S, M, L, XL, XXL

**Fleece-jacket, „Arber“**

zipper in same colour as jacket, seam with elastic drawstring, 2 huge slidepockets with zippers, inside pocket with velcro for cellphones



03871B  
oliv/OD green



03871E  
hunter-snow  
Größen/Sizes: S, M, L, XL, XXL, XXXL



03871G  
hunter-braun/hunter-brown  
Größen/Sizes: S, M, L, XL, XXL, XXXL





00433B

**Fleece-Jacke, „Polar“**

oliv, Schulter- und Ärmelbesatz, viele aufgesetzte Taschen, hochwertige Kunststoffreißverschlüsse, elastische Bündchen

Material: 100 % Polyester, 340g/m<sup>2</sup>

Größen/Sizes: S, M, L, XL, XXL

**Fleece-jacket, „Polar“**

OD green, cargo pockets, high quality plastic zippers, elastic cuffs, shoulder and sleeve trim

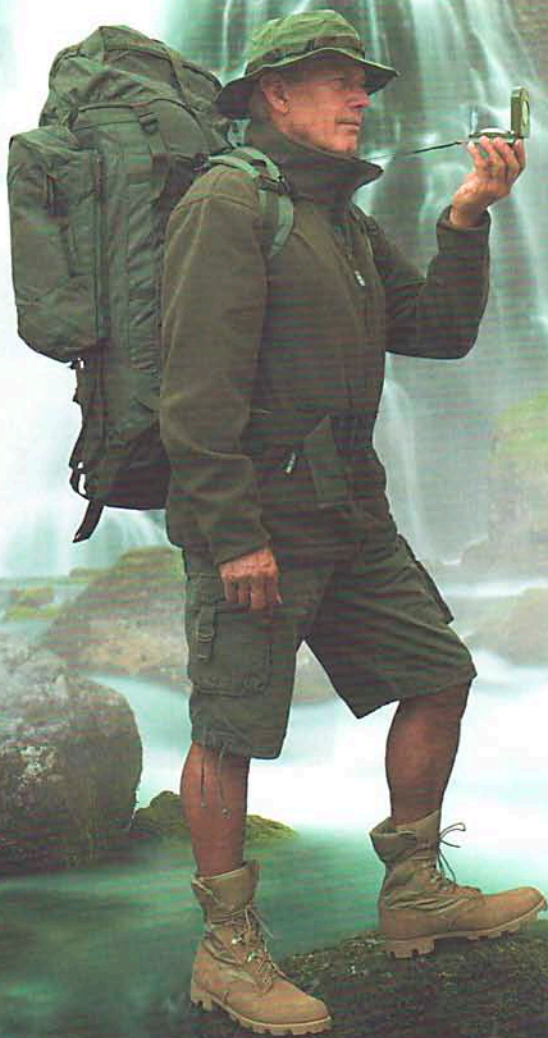

00443B

**Fleece-Weste, „Polar“**

oliv, Schulterbesatz, viele aufgesetzte Taschen, hochwertige Kunststoffreißverschlüsse

Material: 100 % Polyester, 340g/m<sup>2</sup>

Größen/Sizes: S, M, L, XL, XXL

**Fleece-vest, „Polar“**

OD green, shoulder trim, cargo pockets, high quality plastic zippers





**03881A**  
schwarz/black

### Franz. Kälteschutzjacke

Fleece, Full Zip, Ellbogen- und Schulterbesatz, Schulterklappen, Klettband für Namensstreifen und Rangschlaufe im französischen Format, 2 geräumige Schubtaschen mit Reißverschluss, Kordelzug mit Stopper im Kragen, Ärmelbündchen und Bund elastisch  
Material: 100 % Polyester  
Größen/Sizes: S, M, L, XL, XXL

### French cold weatherjacket

fleece, reinforced elbows and shoulders, epaulettes and velcro patches for rank insignia and name tape, french style, 2 huge slide pockets with zippers, seam with elastic drawstring, elastic cuffs and waist



**03881B**  
oliv/OD green  
Größen/Sizes: S, M, L, XL, XXL, XXXL



**03881I**  
CCE tarn/CCE camo



### 03891B

#### Faserpelz-Jacke

oliv, 2 aufgesetzte Einschubtaschen vorne, 2 Einschubtaschen auf Brust, Abdeckleiste am 2-Wege Frontreißverschluss, Kordelzug an Taille, 2 Innentaschen eine mit RV und eine mit Knopf, 1 Handytasche innen mit Klett, Schulterbesatz, verstellbarer Ärmelabschluss per Druckknopf  
Obermaterial/Upper: 70 % Polyester, 30 % Acryl  
Innenmaterial/Lining: 100 % Acryl  
Füllung/Filling: 100 % Polyester  
Größen/Sizes: S, M, L, XL, XXL, 3XL, 4XL

#### Fibre fur jacket

OD green, 2 fitted thrust-in-pockets in front, 2 thrust-in-pockets at the breast, cover strip at 2-way front zip fastener, cord at the waist, 2 inner pockets, one with fastener, one with buttons, 1 handy pocket inner with velcro, shoulder trimming, adjustable cuffs with press buttons





03932D  
night camo-stonewashed



03932F  
sand-stonewashed



**Sommerjacke, „Tom“**

modische Sommerjacke von Pure Trash, Ellbogenbesatz, 2 aufgesetzte Brusttaschen, 2 seitliche Einschubtaschen, Reißverschluss mit geknöpfter Abdeckleiste an der vorderen Mitte, geknöpfter Ärmelabschluss

Material: 100 % Baumwolle/Cotton

Größen/Sizes: S, M, L, XL, XXL

**Summerjacket, „Tom“**

stylish summer jacket by Pure Trash, reinforced elbows, 2 breast pockets, 2 side batch pockets, velcro with snapped cover strip on front middle, snapped sleeves



**Jacke, „Leo“**

modische Sommerjacke von Pure Trash, Ellbogenbesatz, 4 aufgesetzte Fronttaschen, Reißverschluss mit geknöpfter Abdeckleiste an der vorderen Mitte, Gummizug am Ärmelabschluss

Material: 100 % Baumwolle/Cotton

Größen/Sizes: S, M, L

**Jacket, „Leo“**

stylish summer jacket by Pure Trash, reinforced elbows, 4 pockets on front, zipper with snapped coverstrip on front middle, elastic band sleeves



03942A  
schwarz-stonewashed/  
black-stonewashed



03942L  
sand camo-stonewashed

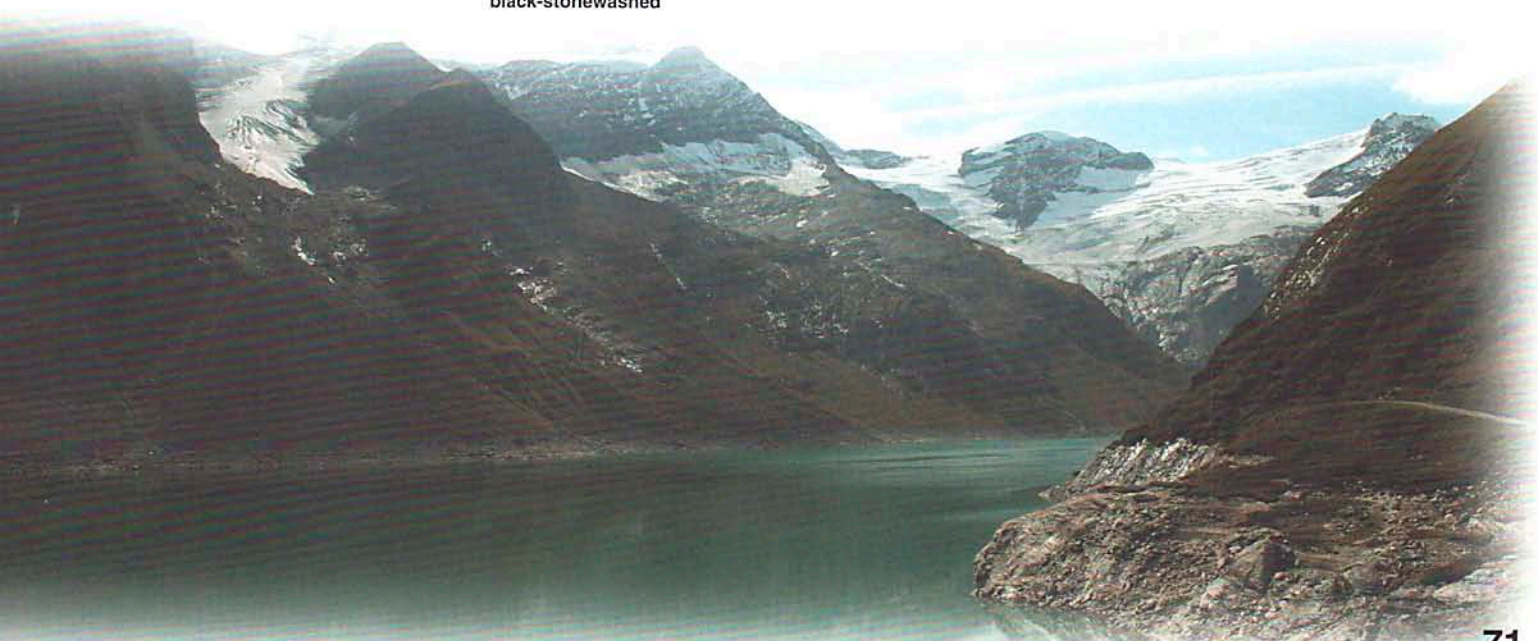



03972F

sand

Größen/Sizes: M, L, XL, XXL



03972A

schwarz/black

**Blouson**

modischer Freizeitblouson mit Kapuze und abnehmbarem Pelzimitat, Ellbogenbesatz, extra warmes Futter aus Fellimitat, abgedeckter Reißverschluss an der vorderen Mitte, 2 Einschubtaschen mit Reißverschluss, 2 Brusttaschen mit Reißverschluss, 1 Handytasche innen mit Klett, Rippbündchen an Ärmel, Bund und Kragen, Stickerei Brust links

Obermaterial/Outer shell: 100 % Baumwolle/Cotton

Futter/Lining: 100 % Polyester

Größen/Sizes: S, M, L, XL, XXL

**Blouson**

stylish leisure jacket with hood and front pockets, reinforced elbows, hood and inside of shoulders with fleece, stitchlining in lower area zipper at front middle, one mobile inside pocket with velcro, one slidepocket inside with zipper, embroidery at left upper arm





03982D  
night-camo



03982B  
oliv/OD green  
Größen/Sizes: S, M, L, XL



03982K  
combat camo

**Feldjacke, „Scout“**

modische Feldjacke mit Kapuze, Teddyfutter an Kapuze und Body, Ellbogenbesatz, Front-Reißverschluss mit geknöpfter Abdeckleiste, 4 aufgesetzte Fronttaschen, 1 Einschubtasche innen mit Druckknopf, innenliegende Strickbündchen im Ärmel, Kordelzug an Taille (weitenverstellbar), Druck auf Kapuze, Klett PT-Schriftzug Brust links  
Obermaterial/Outer shell: 100 % Baumwolle/Cotton  
Futter/Lining: 100 % Polyester  
Größen/Sizes: S, M, L, XL, XXL

**Fieldjacket, „Scout“**

stylish leisure jacket with hood and lining on the hood and body, reinforced elbows, front zipper with buttoned cover molding, 4 patch front pockets, 1 thrust-in-pocket, inside with press button, knitted waistband at the sleeve, cord at the waist (adjustable length), print on the hood, velcro PT-writing at the breast on the left



03992K  
combat camo



03992B  
hell-oliv/light-OD green



**Feldjacke, „Speed“**

Pure Trash, modische Freizeitjacke mit Kapuze im Kragen, Ellbogenbesatz, Reißverschluss an der vorderen Mitte  
Obermaterial/Outer shell: 100 % Baumwolle/Cotton  
Futter/Lining: 100 % Baumwolle/Cotton  
Größen/Sizes: S, M, L, XL, XXL

**Fieldjacket, „Speed“**

stylish leisure jacket with hood and front pockets, reinforced elbows, zipper at front middle



04102A  
schwarz/black



04102B  
oliv/OD green



04102T  
woodland

04103A schwarz/black

04103B oliv/OD green

US Steppweste, Übergrößen

Größen/Sizes: XXXL, 4XL, 5XL

US vest, oversizes



**US Steppweste, gefüttert, mit vielen Taschen**

klassische Steppweste mit Baumwollfutter, 4 aufgesetzte Pattentaschen, 2 seitliche Einschubtaschen, kleiner Tasche an Brusttasche, Reißverschluss und Druckknopfverschluss, an der Hüfte weitenverstellbar

Obermaterial/Outer shell: 65 % Polyester, 35 % Baumwolle/Cotton

Innenfutter/Inner Lining: 100 % Baumwolle/Cotton

Futter/Lining: 100 % Polyester

Größen/Sizes: S, M, L, XL, XXL

**US vest**

classic stitching vest with cotton lining, 4 put-on flap pockets, 2 side slidepockets, small pocket on breastpocket, zipper and snaps, adjustable on the hip

**04123G**

**Jäger Weste**

hunter-braun, wendbar, gefüttert, 2 aufg. Pattentaschen mit Druckknopf und RV, 2 seitl. Einschubtaschen, 1 Rückentasche mit 2 RV, 1 Brusttasche mit RV, alle Taschen sind außen und innen angebracht, Innenseite ist in warnender Signalfarbe

Material: 100 % Polyester

Größen/Sizes: S, M, L, XL, XXL, XXXL

**Hunting vest**

hunter-brown, reversible, lined, 2 welt pockets with press buttons and zipper, 2 side revolver pockets, 1 back pocket with 2 zippers, 1 breast pocket with zipper, all pockets are applied in- and outside, the inside is in a signal color



**04153A**

**Weste, „Windbreaker“**

schwarz, leichte Wendeweste winddicht, außen schwarz, innen oliv, 2 seitl. Einschubtaschen außen

Obermaterial/Outer shell: 100 % Polyamid

Innenfutter/Inner Lining: 100 % Polyester

Größen/Sizes: S, M, L, XL, XXL, XXXL

**Vest, „Windbreaker“**

black, lightweight wind resistant vest, outside black, inside OD green, 2 side thrust in pockets outside







**04253F**  
khaki



**04253A**  
schwarz/black  
Größen/Sizes:  
S, M, L, XL, XXL, XXXL



**04253B**  
oliv/OD green  
Größen/Sizes:  
S, M, L, XL, XXL, XXXL



**04253T**  
woodland

**Canadian-Outdoor-Weste**

multifunktionelle Outdoor-Weste für alle Zwecke, optimal für Hobby, Angeln, Jagen oder Wandern, mit vielen Taschen

Material: 65 % Polyester, 35 % Baumwolle/Cotton  
Größen/Sizes: S, M, L, XL, XXL

**Canadian outdoor-vest**

multifunctional outdoor vest for all occasions! ideal for hobby, fishing, hunting or hiking, with many pockets



passende Hosen, Seite 45  
Artikel-Nr.: 01703



**04303F**  
khaki



**04303A**  
schwarz/black



**04303B**  
oliv/OD green



mit Handytasche und herausnehmbarer Innentasche, als Gürteltasche oder Brustbeutel verwendbar

**Outdoor-Weste**

Microfaser, praktische Outdoorweste für Freizeit, Hobby und Beruf, Netzfutter, 7 Außentaschen mit Druckknöpfen bzw. Reißverschluss, 1 Handytasche innen, 1 herausnehmbare Innentasche mit 3 Reißverschlüssen mit Klett befestigt, auch als Gürteltasche oder Brustbeutel verwendbar, Taillenbund mit Kordelzug

Material: 70 % Baumwolle/Cotton, 30 % Nylon  
Größen/Sizes: S, M, L, XL, XXL

**Outdoor-vest**

functional outdoor vest for free time and work, netlining, 7 pockets with snaps or zippers outside, 1 cellphone pocket inside, 1 detachable pocket with 3 zippers and with velcro attached in inside, usable as belt-pocket or chestbag, waistband with drawstring



04453A

**Weste, „S.W.A.T.“**

schwarz, Lederbesatz, 12 abnehmbare Außentaschen verschließbar, mit Reißverschlüssen, Klett- oder Plastikclip, Außentaschen mit Klett- und Druckknöpfe befestigt, seitlich an Schulter und Front größenverstellbar

Material: 100 % Nylon

**Vest, „S.W.A.T.“**

black, leather edging, 12 detachable outside pockets with zippers, plastic clips and velcro, attached with velcro and snaps, adjustable at the side in width on shoulders and front



Rückansicht



04503B  
oliv/OD green



04503A  
schwarz/black



Rückansicht

**Tactical-Weste, mit Lederbesatz**

größenverstellbar, 12 Außentaschen mit Klett- bzw. Plastikverschluss, Verschluss vorne mit breitem Klettband und praktischen Plastikverschlüssen

Material: 100 % Nylon

**Tactical vest, with leather**

adjustable, 12 outside pockets with velcro or plastic snaps, seal in the front with wide velcroband and functional plastic snaps



04553B  
oliv/OD green



04553A  
schwarz/black

**Tactical-Weste, mit Netzeinsatz**

2 große Innentaschen mit Klettverschluss, 9 Außentaschen mit Klettverschluss, Befestigungsschlaufen für verschiedene Koppel, größenverstellbar mit Schnüren

Material: 100 % Nylon

**Tactical vest, with net**

2 big inside pockets with velcro, 9 outside pockets with velcro, fastening clews for different belts, adjustable with strings



04553Q  
AT-digital



Rückansicht



04553T  
woodland



passendes Zubehör  
auf Seite: 199-203



04563R  
coyote tan



04563A  
schwarz/black



04563B  
oliv/OD green



04563Q  
AT-digital



04563T  
woodland



Rückansicht

**Weste, „Tactical Armor“**

Modular-System, geschraubte, längenverstellbare, gefütterte Schulterträger mit PVC-Besatz, Abwurfsystem, größenverstellbar per Schnürsystem am Rücken, Brust und Rückenfach mit herausnehmbarem Polster auch für Schutzplatten geeignet, Rettungsgriff hinten

Material: 100 % Nylon

**Vest, „Tactical Armor“**

modular, screwed, adjustable, padded shoulderstrap with PVC-edging, drop-system, adjustable at the back, breast and backcase with removable bolster, rescue holder at the back



Rückansicht



04573V  
flecktarn/BW camo

**Weste, „Combat“**

Taktische Weste mit Abwurfsystem, größenverstellbar, abklettbarer Schulterschutz, Rettungsgriff mit Klettsicherung, 1 Mehrzwecktasche mit Reißverschluss, 1 flache Ausrüstungstasche, 1 Funkgerätetasche, 2 Pistolenmagazintaschen, alle Taschen abnehmbar

Material: 100 % Polyester

**Vest, „Combat“**

tactical vest with dropping-system, adjustable in size, detachable shoulder-protection with velcro, rescue handle with velcro security, 1 all-purpose pocket with zipper, 1 flat equipment pocket, 1 radio pocket, 2 pockets for pistol-magazines, all listed pockets are detachable



04573A  
schwarz/black



04573B  
oliv/OD green



04573Q  
AT-digital



04573R  
coyote tan



04583V  
flecktarn/BW camo



04583A  
schwarz/black



04583B  
oliv/OD green



04583Q  
AT-digital



04583T  
woodland



Rückansicht

**Weste, „Ranger“**

taktische Weste mit integriertem Trinksystem, abnehmbarer Frontbeutel mit Klettfläche, 2 Doppelmagazintaschen M4 (für 4 M4 oder 2 G36/AUG Magazine), 1 Einzelmagazintasche M4 (für 2 M4 oder 1 G36/AUG Magazin), 1 Doppelmagazintasche MP (für 2 MP7/MP5 Magazine), abnehmbarer Trinkrucksack mit Beutel und Schlauch  
Material: 100 % Nylon

**Vest, „Ranger“**

tactical vest with drinking-system, detachable front pocket with velcro, 2 double-magazine-pouches M4 (for 4 M4 or 2 G36/AUG magazines), 1 single-magazine-pouch M4 (for 2 M4 or 1 G36/AUG magazines), 1 double-magazine-pouch MP (for 2 MP7/MP5 magazines), detachable drinking rucksack with a bag and flexible tube



04593Q  
AT-digital



04593A  
schwarz/black



04593B  
oliv/OD green



Rückansicht

passendes Zubehör  
auf Seite: 199-203



04593R  
coyote tan



04593T  
woodland



**Weste, „Molle II“**

mit Futter, Modular-System, längenverstellbare gefütterte Schulterträger, Hüftbereich verstellbar per Schnürung und Klett, gepolstertes Front- und Rückenteil, Netzfutter, 4 seitlich abgedeckte Fächer, innere Einschubfächer vorne und hinten für Schutzplatten, Rettungsgriff im Nacken, abnehmbarer Hüftgurt zum separaten Tragen

Material: 100 % Nylon

**Vest, „Molle II“**

with lining, modular, length adjustable, padded shoulderstrap, bottom adjustable per lacing and velcro, padded front- and backside, with netlining, inside slash pockets in front and back for protection plate, rescue-holder in the neck, detachable waistbelt

passendes Zubehör  
auf Seite: 199-203



04613T  
woodland



Rückansicht



04613A  
schwarz/black



04613B  
oliv/OD green

**Weste, „Molle Light“**

Modular-System, verstellbare Schulter- und Seitenteile, 1 große Rückentasche mit Klett und je 1 Seitentasche mit Reißverschluss, innen aus robustem Netzmaterial, Gurtschlaufen vorne und hinten mit Druckknopf und Klett, Tragegriff hinten

Material: 100 % Polyester 900D

**Vest, „Molle Light“**

modular, adjustable shoulder- and sides, 1 big back bag with velcro, 1 side pocket with zip, inside made by stable net material, belt loops front and back with button and velcro, carrying handle at the back



30993B  
oliv/OD green



30993A  
schwarz/black



30993J  
Typ 95 CZ tarn/CZ camo

**Tactical-Weste**

mit 12 Taschen, verstellbaren, gepolsterten Schulterriemen und Netzeinsätzen

Material: 100 % Nylon

**Tactical-Vest**

with 12 pockets, adjustable and padded shoulder straps and net inserts



30993Q  
AT-digital



30993T  
woodland



30993V  
flecktarn/BW camo





05021B  
oliv/OD green  
05601B  
oliv/OD green



05021A  
schwarz/black  
05601A  
schwarz/black



05021G  
blau/blue  
05601G  
blau/blue



05021

**BW Pullover, Mod.**

mit Brusttasche und Schulterklappen,  
Ellbögen und Schultern mit Segeltuchbesatz  
Material: 80 % Wolle/Wool, 20 % Polyacryl  
Größen/Sizes: 48, 50, 52, 54, 56, 58, 60, 62

**BW pullover**

with breastpocket and epaulettes,  
elbows and shoulders with sailcloth trimming

05601

**BW Pullover, Mod.**

mit Brusttasche und Schulterklappen,  
Ellbögen und Schultern mit Segeltuchbesatz,  
Hoheitsabzeichen zum Aufnähen liegt bei!

Material: 100 % Acryl  
Besatz/Edging: 65 Polyester, 35 % Baumwolle/Cotton

Größen/Sizes: 48, 50, 52, 54, 56, 58, 60, 62, 64

**BW pullover**

with breastpocket and epaulettes,  
elbows and shoulders with sailcloth trimming



05505G  
blau/blue



05505A  
schwarz/black



05505B  
oliv/OD green

**Isländer Pullover, Troyer**

mit Reißverschluss, Grobstrick, Gewicht 650 g

Material: 100 % Polyacryl

Größen/Sizes: S, M, L, XL, XXL, XXXL

**Navy sweater**

with zipper, rough knit, weight 650 g





**05701B**  
oliv/OD green



**05701A**  
schwarz/black



auch als Fleece-Jacke tragbar!

**Jäger-Wendejacke**

Fleece-Strick, 2 Einschubtaschen mit Reißverschluss auf jeder Seite, auf der Strickseite Ellbogen- und Schulterbesatz

Material: 70 % Acryl, 30 % Wolle/Wool

Futter/Lining: 100 % Polyester-Fleece

Größen/Sizes: S, M, L, XL, XXL, XXXL

**Hunter-reversible vest**

fleece-knitwear, reversible jacket, 2 slanted pockets with zipper of each side, on the rope side elbow- and shoulderedging



**BW Parka, oliv**

Nachbau des altbewährten BW Parka, feste Kapuze, Schulterklappen, ausknöpfbare Teddyfutter, 2 Brust- und 2 Schubtaschen mit Abdeckklappe, Kordelzug am Saum, geknöpfte Windabweckleiste am Front-Reißverschluss

Material: 100 % Baumwolle/Cotton

Futter/Lining: 100 % Polyacryl

**BW parka, OD green**

remake of bw parka, hood, epaulettes, detachable lining, 2 breast- and slanted pockets, drawstring at the border, buttoned at the front-zipper



- 06105 Größen/Sizes: 48, 50, 52, 54, 56
- 06106 Größen/Sizes: 58, 60
- 06107 Größen/Sizes: 62, 64, 66



**07353**

**BW Panzerkombi-Futter**

oliv, Mod., zum Unterziehen für Panzerkombi

Material: 100 % Nylon

Füllung/Filling: 100 % Polyethylen

Futter/Lining: 100 % Nylon

Größen/Sizes: S, M, L, XL, XXL, XXXL

**BW tank coverall lining**

OD green, model, to wear under a tank coverall



**07303B**

**Panzerkombi**

oliv, ohne Futter, Mod.

Material: 65 % Polyester

35 % Baumwolle/Cotton

Größen/Sizes: S, M, L, XL, XXL, XXXL

**BW tank coverall**

OD green, without lining, model



**07373A**

**Overall, „Security“**

schwarz, 2-Wege-Frontreißverschluss, 2 Brusttaschen, 2 Hüfttaschen, 2 Beintaschen, 1 Ärmeltasche, alle Taschen mit Reißverschluss, Kordelzug an Taille, Reißverschluss an Ärmel- und Beinenden, Lieferung mit je einem bedruckten und unbedruckten Rückenpatch

Material: 65 % Polyester, 35 % Baumwolle/Cotton

Größen/Sizes: S, M, L, XL, XXL, XXXL

**Coverall, „Security“**

black, 2-way-front zipper, 2 breast pockets, 2 hip and 2 leg pockets, 1 sleeve pocket, all pockets with zip, drawstring at the waist, zipper at the leg border, printed and unprinted back patch





07703T  
woodland



07703L  
schneetarn/snow camo



07703Z  
desert



#### Tarnanzug, „Ghillie Suit“

4-teilig, Hose, Jacke, Kopfbedeckung und Gewehrabdeckung, Kunststoff-Druckknöpfe an Jacke, Gummiband und Zugband mit Kordelstopper an Hosentaille, 2 Durchgreiftaschen, elastischer Beinabschluss, Druckknopfleiste an Beinenden, Kopfbedeckung mit Sichtfenster aus Netzgewebe, Gewehrabdeckung aus Elastikband mit jeweils einer Schlaufe am Ende, Fadentarnung

Material: 100 % Polyester feuerhemmend/fire-resistant

Größen/Sizes: M/L, XL/XXL

#### Ghillie suit

4 parts set, trousers, jacket, headgear and shotgun cover, plastic buttons at the jacket, elastic band and drawstrings with cord stopper at the trouser waistband, 2 through pockets, elastic leg border, buttoned leg border, headgear with vision panel made by netting, shotgun cover of elastic band with buckles on each end, thread camouflage

#### 07713G

##### Tarnanzug, „Leaves“

hunterbraun, 3-teilig (Jacke, Hose und Balaclava),  
Jacke: Kordelzug an Kapuze, Gummizug am Bund und Ärmelabschluss,  
Hose: Gummizug am Bund und Beinabschluss,  
Balaclava: aufklappbares Moskitonetz

Material: 65 % Polyester, 35 % Baumwolle/Cotton

Größen/Sizes: M/L, XL/XXL

##### Camo suit, „Leaves“

hunterbrown, 3-parts (jacket, trousers and balaclava),  
jacket: cord at the hood, elastic at the waist and cuffs,  
trousers: elastic at the waist and leg bottom,  
balaclava: opened mosquito net



#### 07610

##### BW Schneetarnanzug

Jacke:  
Kordelzug an Kapuze, 1 Brusttasche außen und  
1 Brusttasche innen mit Druckknöpfe, verstellbarer  
Ärmelabschluss per Druckknopf

Hose:  
elastischer Hosenbund mit Gummizug, 2 abgedeckte  
Durchgreiftaschen seitlich, 2 abgedeckte Beindurch-  
greiftaschen, Bandzug am Beinende

Material: 100 % Baumwolle/Cotton

Größen/Sizes: S/M, L/XL, XXL/XXXL

##### BW snow camo suit

jacket:  
cord at the hood, 1 breast pocket outside and  
1 breast pocket inside with press buttons, adjustable  
cuffs with press buttons

trousers:  
elastic trouser waistband with elastic band,  
2 covered side through pockets, 2 covered leg through  
pocket, drawstring at leg bottom



# Ponchos



08524A  
schwarz/black



08524T  
woodland



08524V  
flecktarn/BW camo



08524B  
oliv/OD green



08203  
Poncho Vinyl  
oliv, 0,12 mm  
Material: 100 % PVC  
Größe/Size: 200 x 127 cm  
Poncho, vinyl  
OD green, 0,12 mm

## US Poncho, Rip Stop, Mod.

Nähte verschweißt

Material: 100 % Polyamid  
PVC beschichtet/coated

Größe/Size: 144 x 223 cm

US poncho, rip stop, mod.  
stiches welded



# Regenbekleidung



**08853B**  
oliv/OD green



**08853A**  
schwarz/black

## Regenjacke

Nähte verschweißt  
 Material: 100 % Polyester  
 PVC beschichtet/coated  
 Größen/Sizes: S, M, L, XL, XXL  
**Rain jacket**  
 stiches welded



**08863B**  
oliv/OD green



**08863A**  
schwarz/black



verpackt in Tasche!



mit Kapuze im Kragen!



## Regenhose

Nähte verschweißt  
 Material: 100 % Polyester  
 PVC beschichtet/coated  
 Größen/Sizes: S, M, L, XL, XXL  
**Rain pants**  
 stiches welded

## 08633A

### ECWCS Regenjacke GEN III

schwarz, Fleece-Futter, herausnehmbare Fleeceinnenjacke mit div. Taschen und Flauschklettpatches, Kordelzug an Taille, eingearbeitete Kapuze im Kragen, 2 abgedeckte Einschubtaschen mit Klett, Aufnahme für Rangschlaufe, 2 Einschubtaschen mit wasserfesten Reißverschluss auf Brust, Ellbogenbesatz, 2 Ärmeltaschen mit Klett, Belüftungsschlitz mit Reißverschluss unter den Armen, weitenverstellbare Ärmel mit Klettverschluss

Material: 100 % Nylon PTFE laminiert/laminated  
 Größen/Sizes: S, M, L, XL, XXL, XXXL

### ECWCS rain jacket GEN III

black, detachable fleece inner jacket with different pockets and fleece velcro patch, cord at the waist, integrated hood in the collar, 2 covered thrust in pockets with velcro, rank insignia cloth, 2 thrust in pockets with waterproof zipper on the breast, elbow reinforcement, 2 sleeve pockets with velcro, aeration fly with zipper under the arms, adjustable sleeves with velcro



mit Fleece-Innenjacke

08873A

## Regenjacke, „Rachel“

schwarz, leichte Regenjacke, wasser- und winddicht, Kapuze mit Kordelzug im Kragen, Frontreißverschluss mit Windschutzleiste, 2 seitliche Einschubtaschen mit Reißverschluss, 1 Rückentasche mit RV, Sicherheits-Reflexstreifen, Rückenbelüftung, Belüftungslöcher unter den Armen, elastischer Kordelzug mit Stoppfern im Bund, 1 Innentasche mit Klett, verstellbare Ärmelbündchen per Klett, Netzfutter im oberem Rückenbereich

Material: 100 % Polyester  
Größen/Sizes: S, M, L, XL, XXL, XXXL

## Rain jacket, „Rachel“

black, light wind jacket, water and wind resistant, hood with cord in the collar, front zip fastener with windbreak strip, 2 side thrust-in-pockets with zip fastener, 1 back pocket with zip fastener, security-reflex parts, ventilation of the back, ventilation holes under the arms, elastic cord with stoppers at the waistband, 1 inside pocket with velcro, adjustable cuffs with velcro, mesh lining in the back



WATERPROOF - WINDPROOF - BREATHABLE



08901H

## Regenjacke, „High Mountain“

schwarz/grün, wasser-, winddicht, atmungsaktiv, hoher Tragekomfort, Kordelzug mit Stopper am Bund und Kragen, abnehmbare Kapuze per Druckknopf und RV im Kragen, 7 Fronttaschen, davon 2 Pattentaschen mit Klett, 3 mit wasserdichtem RV und 2 mit abgedecktem RV, Abdeckleiste mit Druckknöpfe am Frontreißverschluss, 1 Brustinnentasche mit RV, 2 Netzinntaschen, Netzinntasche, verstellbarer Ärmelabschluss per Klett

Material: 100 % Polyester  
Größen/Sizes: S, M, L, XL, XXL, 3XL, 4XL

## Rain jacket, „High Mountain“

black/green, waterproof, windproof, breathable, wear comfort, cord with stopper at waist and collar, detachable hood with press buttons and zipper in the collar, 7 front pockets, out of which 2 flap pockets with velcro, 3 with waterproof zipper and 2 with covered zipper, cover molding with press buttons at the front zipper 1 breast internal pockets with zipper, 2 mesh internal pockets, mesh lining, adjustable cuff with velcro





09015G  
blau/blue



09015A  
schwarz/black



**US Pea Coat**

klassischer US Marine Pea Coat, 2 große Schubtaschen,  
1 Innentasche, doppelte Knopfreihe,  
PVC-Knöpfe mit Ankeremblem  
Obermaterial/Outside: 70 % Wolle/Wool, 30 % Viskose  
Innenmaterial/Lining: 100 % Polyester (gesteppt/stitched)  
Größen/Sizes: XS, S, M, L, XL, XXL

**US pea coat**

classic US Marine Pea Coat, 2 big slanted pockets and  
one inside pocket, double button row,  
PVC-buttons with anchor-emblem



09503

**Netzmantel**

oliv, mit Schlaufen, zur Tarnung, abnehmbare Kapuze  
mit Klettband und Druckknöpfe, Transportbeutel  
Material: 100 % Nylon

**Mash Coat**

OD green, with loops, detachable hood with velcro  
and button, carry bag



**10104B**  
grün/green



**10104G**  
blau/blue  
Größen/Sizes: 56, 57, 58, 59, 60, 61



**10104A**  
schwarz/black



**10104I**  
korallrot/red

**Commando Barett, Mod.**

Obermaterial/Outer Shell: 100 % Wolle/Wool  
Innenmaterial/Lining: 100 % Baumwolle/Cotton  
Rand/Border: Leder/Leather  
Größen/Sizes: 56, 57, 58, 59, 60, 61, 62

**Commando beret, mod.**



**10103A**

**BW Barett**

schwarz, Mod.

Obermaterial/Outer Shell: 100 % Wolle/Wool  
Innenmaterial/Lining: 100 % Baumwolle/Cotton  
Rand/Border: Leder/Leather  
Größen/Sizes: 56, 57, 58, 59, 60, 61, 62

**BW beret**

black, mod.





10010

**Pelz Hut, „Trapper“**

Hasenfell, braun

Material: 100 % Polyester, echtes Fell/natural fur

Größen/Sizes: S, M, L, XL

**Fur hat, „Trapper“**

rabbit fur, brown



10020

**Fellmütze**

schwarz, mit grauem Kaninchenfell, Steppfüterung

Material: 100 % Polyester, echtes Fell/natural fur

Größen/Sizes: S, M, L, XL

**Fur winter cap**

black, with grey rabbit fur, with polyester-lining



10023

**Ledermütze**

mit Hasenfell, braun

Material: Leder, echtes Fell/Leather, natural fur

Futter/Lining: 100 % Polyester

Größen/Sizes: S, M, L, XL

**Leather hat**

with rabbit fur, brown



10033I

**Holzfallermütze**

mit Fell, rot/schwarz

Material: 100 % Polyester

Größen/Sizes: S, M, L, XL

**Woodcutter hat**

with fur, red/black



10142N  
braun/brown



10142A  
schwarz/black



**Cabrio Leder Cap**

Sommer-Ausführung

Material: 100 % Leder/Leather

Futter/Lining: 100 % Baumwolle/Cotton

Größen/Sizes: S, M, L, XL, XXL

**Cabrio leather cap**

summer-style



**Cabrio Leder Cap**

Winter-Ausführung, gefüttert

Material: 100 % Leder/Leather

Futter/Lining: 100 % Polyester

Größen/Sizes: S, M, L, XL, XXL

**Cabrio leather cap**

winter-style, lined



10146A  
schwarz/black



10146N  
braun/brown

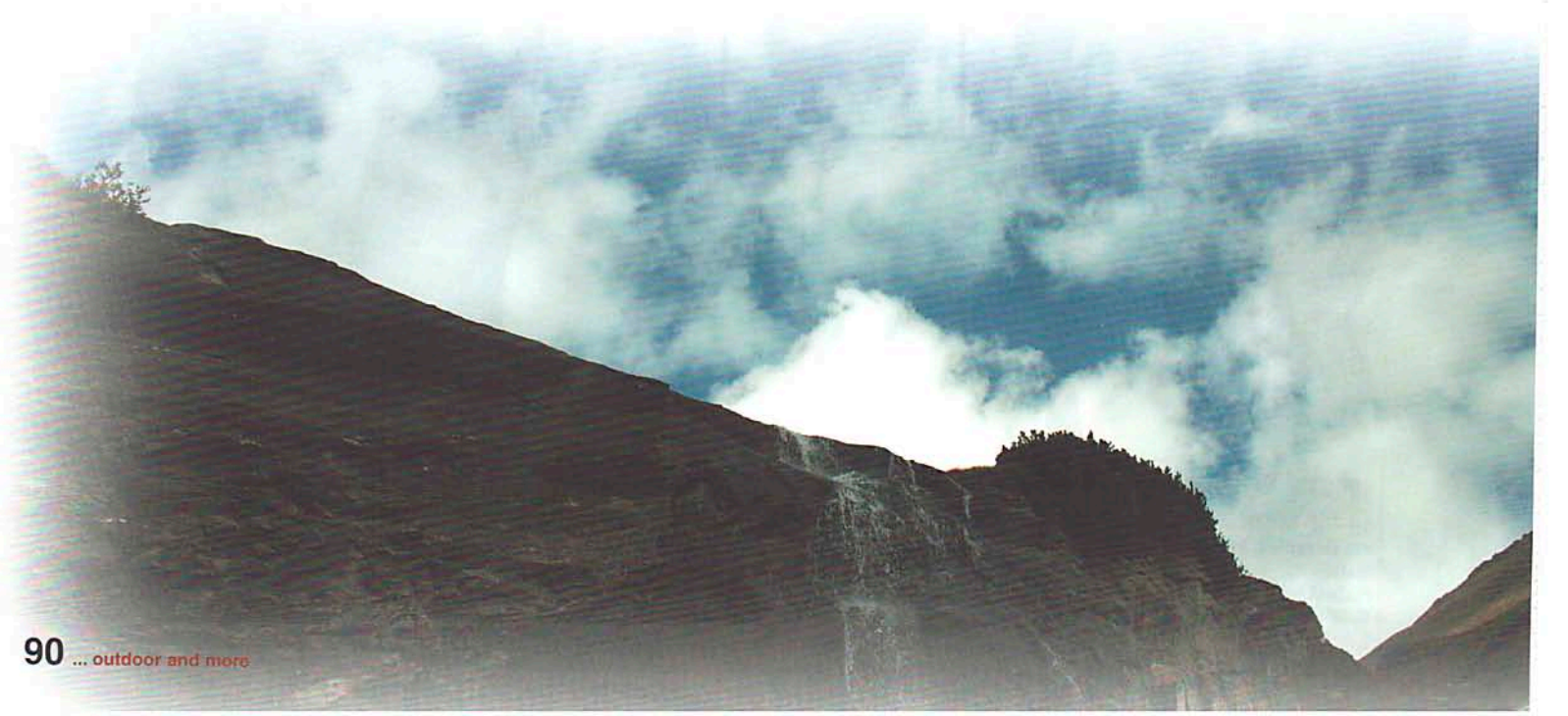





**10163C**  
tiger stripe



**10163A**  
schwarz/black



**10163S**  
digital woodland



**10163T**  
woodland

**Headwrap**

**Material:** 100 % Baumwolle/Cotton  
**Größen/Sizes:** Einheitsgröße/one size fits all

**Headwrap**



**10163W**  
6 Farben desert/  
6 colour desert



**10163Z**  
3 Farben desert/  
3 colour desert



**10164Q**  
USA Fahne/USA banner



**10164B**  
paisley-oliv/  
paisley-OD green



**10164G**  
paisley-navyblau/  
paisley-navy



**10164I**  
paisley-rot/  
paisley-red

**10154**

**Headwrap**

schwarz, Lederimitation  
**Material:** 100 % PVC  
**Größen/Sizes:** Einheitsgröße/one size fits all

**Headwrap**

black, leather imitation

**Headwrap**

**Material:** 100 % Baumwolle/Cotton  
**Größen/Sizes:** Einheitsgröße/one size fits all

**Headwrap**



# Kopfbedeckungen

ORIGINAL MILSPEC



10213A  
schwarz/black



10213B  
oliv/OD green



10213C  
tiger stripe



10213Z  
3 Farben desert/3 colour desert



10213D  
hunter snow



10213E  
digital woodland



10213F  
khaki



10213G  
hunter-braun/hunter-brown



10213H  
hunter-grün/hunter-green



10213I  
CCE camo



10213J  
Typ 95 CZ tarn/CZ camo



10213K  
night-camo



10213L  
vegetato



10213M  
vegetato desert



10213N  
snow tarn/snow camo



10213P  
oliv-stonewashed/OD green-stonew.



10213R  
coyote tan



10213S  
woodland-stonewashed



10213T  
woodland



10213U  
urban



10213V  
flecktarn/BW camo



10213W  
6 Farben desert/6 colour desert



10213Y  
BW tropentarn/BW tropical camo



## US BDU Feldmütze, Rip Stop

klassische US Feldmütze, mit Schild  
Material: 100 % Baumwolle/Cotton  
Größen/Sizes: S, M, L, XL, XXL

US BDU field cap, rip stop  
classic US field cap, with visor





10223B  
oliv/OD green



10223A  
schwarz/black



10223M  
grau/grey



**US Cap, „Elasti-Fit“**

Rip Stop, mit Schild

Material: 98 % Baumwolle/Cotton, 2 % Elasthan

Größen/Sizes: Einheitsgröße/one size fits all

**US cap, „Elasti-Fit“**

rip stop, with visor



**US Cap, USMC, Rip Stop**

mit Marine-Corp-Druck, gefüttert mit Außenmaterial

Material: 100 % Baumwolle/Cotton

Größen/Sizes: S, M, L, XL

**US cap, USMC, rip stop**

with marine corp print, lined with outside material



10233A  
schwarz/black



10233C  
tiger stripe



10233T  
woodland



10233B  
oliv/OD green



# Kopfbedeckungen



**10273C**  
splinter-tarn/splinter-camo



**10273A**  
schwarz/black



**10273B**  
oliv/OD green



**10273F**  
khaki



**10273Q**  
sumpftarn/BGS camo



**10273T**  
woodland



**10273U**  
urban



mit verstellbarem  
Plastikverschluss!

## US-Cap, mit Schild

größenverstellbar

Material: 65 % Polyester, 35 % Baumwolle/Cotton

Größen/Sizes: Einheitsgröße/one size fits all

US cap, with visor

size-adjustable



**10273V**  
flecktarn/BW camo



**10273Y**  
BW tropentarn/  
BW tropical camo



**10273Z**  
3 Farben desert/  
3 colour desert



## 10253Q

### US Feldmütze, ACU

AT-digital, Rip Stop, gefüttert mit Außenmaterial,  
Klettverschluss

Material: 100 % Baumwolle/Cotton

Größen/Sizes: S, M, L, XL, XXL

### US fieldcap, ACU

AT-digital, rip stop, lined with outside material,  
velcro



ORIGINAL MILSPEC

## Cap, „Gobi“

kurzer Nackenschutz, Belüftungslöcher

Material: 100 % Polyester

Größen/Sizes: Einheitsgröße/one size fits all

## Cap, „Gobi“

short neck protection, ventilation holes



**10426B**  
oliv/OD green

**10426F**  
khaki



**10424F**  
khaki



## Cap, „Sahara“

langer Nackenschutz, Belüftungslöcher

Material: 100 % Polyester

Größen/Sizes: Einheitsgröße/one size fits all

## Cap, „Sahara“

long neck protection, ventilation holes

**10424B**  
oliv/OD green



10291T  
woodland-vintage

**-VINTAGE-**



10291A  
schwarz-vintage/black-vintage



10291B  
oliv-vintage/OD green-vintage



10291F  
khaki-vintage

**Army Cap, „GI“**

Canvas  
Material: 100 % Baumwolle/Cotton  
Größen/Sizes: Einheitsgröße/one size fits all  
Army cap, „GI“  
canvas



10291M  
grau camo-vintage/grey camo-vintage



10295L  
sand camo-vintage



10295A  
schwarz-vintage/black-vintage



10295B  
oliv-vintage/OD green-vintage



10295K  
combat camo-vintage



10295Z  
3 Farben desert-vintage/  
3 colour desert-vintage



**Army Cap, „Combo“**

Canvas  
Material: 100 % Baumwolle/Cotton  
Größen/Sizes: Einheitsgröße/one size fits all  
Army cap, „Combo“  
canvas



10280A

**US Cap, „Security“**

schwarz, bestickt, mit Schild und Plastikverschluss

Material: 65 % Polyester, 35 % Baumwolle/Cotton

Größen/Sizes: Einheitsgröße/one size fits all

**US cap, „Security“**

black, embroidered, with shield and plastic clip, adjustable



10313E  
hunter-snow



10313G  
hunter-braun/hunter-brown



**Cap, orange Leuchtstreifen**

wasserdicht, atmungsaktiv, geräuscharm

Material: 100 % Polyester

Größen/Sizes: S, M, L, XL

**Cap, orange strip**

waterproof, breathable, quiet



mit verstellbarem  
Messingverschluss!



10343A  
schwarz/black



10343F  
khaki

**BB Cap, flach**

Stoffflasche mit Messingverschluss, brushed

Material: 100 % Baumwolle/Cotton

Größen/Sizes: Einheitsgröße/one size fits all

**Baseball cap, flat**

brass closures



10343B  
oliv/OD green

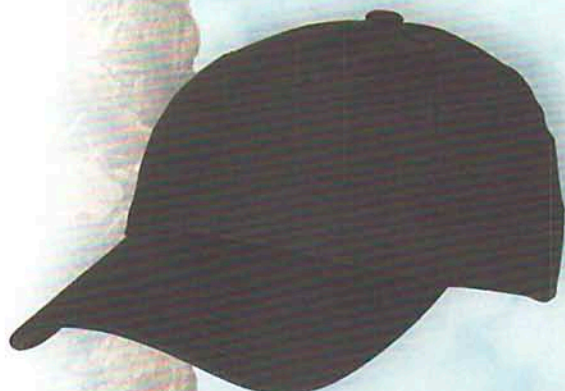

mit elastischem Bund!

10353A

**BB Cap, „Elasti-Fit“**

schwarz, „Pro Company“, elastisch, optimaler Tragekomfort, ohne Verschluss

Material: 98 % Baumwolle/Cotton, 2 % Elasthan

Größen/Sizes: Einheitsgröße/one size fits all

**Baseball cap, „Elasti-Fit“**

black, elastic, optimal wear comfort, no closure

10363A

**BB Cap**

schwarz, mit Klettverschluss, gebogenes Schild

Material: 98 % Baumwolle/Cotton, 2 % Elasthan

Größen/Sizes: Einheitsgröße/one size fits all

**Baseball cap**

black, velcro, curved shield



mit Klettverschluss!



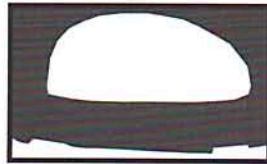

mit Klettverschluss!



10381

**BB Cap, „Deutschland“**

Sandwich, schwarz mit gelbem Streifen, Klettverschluss

Material: 100 % Baumwolle/Cotton

Größen/Sizes: Einheitsgröße/one size fits all

**BB Cap, „Deutschland“**

black, yellow stripe, sandwich, velcro

10382

**BB Cap, „Deutschland“**

schwarz/rot/gold, Klettverschluss

Material: 100 % Baumwolle/Cotton

Größen/Sizes: Einheitsgröße/one size fits all

**BB Cap, „Deutschland“**

black/red/yellow, velcro



mit verstellbarem Klemmverschluss!

10383A

**BB Cap, „Totenkopf“**

schwarz, verstellbarer Klemmverschluss,

Totenkopf gestickt

Material: 100 % Baumwolle/Cotton

Größen/Sizes: Einheitsgröße/one size fits all

**BB Cap, „Skull“**

black, adjustable stick zipper, embroidered skull

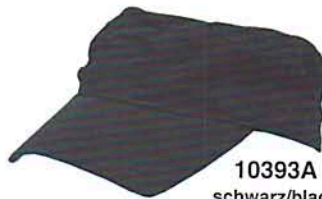

10393A  
schwarz/black



10393B  
oliv/OD green

**BB Cap**

mit eckigem Schild, Klettverschluss

Material: 100 % Baumwolle/Cotton

Größen/Sizes: Einheitsgröße/one size fits all

**Baseball cap**

cornered look, velcro



mit Nackenschutz!

10428A

**BB Cap, mit Nackenschutz**

schwarz, Messing-Belüftungslöcher, Druckknöpfe am Nacken

Material: 100 % Polyester

Größen/Sizes: S, M, L

**BB Cap, with neck protection**

black, brass-ventilation holes, snaps at the neck



10433A  
schwarz/black



10433G  
blau/blue



mit Klettverschluss!



**Cap, ohne Schild, Pro Company**

mit Klettverschluss, Stickrand, Luftlöcher, Messingniete Kopf Mitte

Material: 100 % Baumwolle/Cotton

Größen/Sizes: Einheitsgröße/one size fits all

**Cap, without visor, Pro Company**

knitted cuffs, ventilation holes, brass rivet in the middle of the head

# Kopfbedeckungen



10545Q  
AT-digital



10545J  
CZ tarn/CZ camo



10545T  
woodland



10545V  
flecktarn/BW camo



## US Helm

Kunststoff, mit Stoffbezug  
Größen/Sizes: Einheitsgröße/one size fits all  
**US helmet**  
plastic, with cloth cover

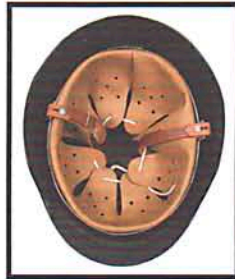

10553Q  
chrom/chrome



10553B  
oliv/OD green



10553A  
schwarz/black

## Stahlhelm, „WW II“

mit Leder-Innenteil  
Größen/Sizes: Einheitsgröße/one size fits all  
**Steelhelmet, „WW II“**  
with leather core



10555A  
schwarz/black



10555B  
oliv/OD green



## US Helm, „MICH“

Kunststoff, größenverstellbar an Kinn- und Nackenband, Klett-Innenpolster anpassbar, keine Schutzfunktion, nur zur Dekoration geeignet  
Größen/Sizes: Einheitsgröße/one size fits all  
**US helmet, „MICH“**  
plastic, styled after the U.S. „MICH“ helmet, adjustable chin strap, cushioned liner, no protective function, use just as a decoration



## 10573B

### BW Helm, ABS

oliv, verstellbare Kopfgröße per Klett, Kinn- und Nackenband längenverstellbar  
Größen/Sizes: Einheitsgröße/one size fits all  
**BW helmet, ABS**  
OD green, adjustable head size by velcro, chin and neckstrap adjustable







**10583B**  
oliv/OD green



**10583A**  
schwarz/black



**Fallschirmspringerhelm, WW II**  
mit Lederinnenteil  
Größen/Sizes: Einheitsgröße/one size fits all  
**Paratrooper helmet, WW II**  
with leather core



**10501B**  
oliv/OD green



**10501A**  
schwarz/black



**10501Q**  
AT-digital



**10501R**  
coyote tan



**10501T**  
woodland



**10501V**  
fleckarn/BW camo

**Helmbezug**  
mit Taschen, größenverstellbar  
Größen/Sizes: Einheitsgröße/one size fits all  
**Helmetcover**  
with pockets, adjustable



**10491**  
**US Helmgummiband**  
oliv, mit Leuchtpunkten  
Größen/Sizes: Einheitsgröße/one size fits all  
**US helmet elastic band**  
OD green, with reflectors



**10465**  
**Moskito-Kopfnetz**  
oliv/woodland, Stoffeinsatz, Gummizug  
Material: 100 % Nylon  
Größen/Sizes: Einheitsgröße/one size fits all  
**Mosquito-headnet**  
OD green/woodland, fabric insert, elastic band



**10467**  
**Moskito-Kopfnetz**  
Stoffeinsatz, oliv, Metallring  
Material: 100 % Nylon  
Größen/Sizes: Einheitsgröße/one size fits all  
**Mosquito-headnet**  
fabric insert, OD green, metal ring

# Kopfbedeckungen



**10653T**  
woodland



**10653A**  
schwarz/black



**10653B**  
oliv/OD green



**10653V**  
flecktarn/BW camo

## Schlapphut (Fischermütze)

mit kleiner Seitentasche

Material: 65 % Polyester, 35 % Baumwolle/Cotton

Größen/Sizes: 55, 57, 59, 61

Fisher hat

small side pocket



**10663O**  
schwarz-stonewashed/black-stonewashed



**10663S**  
khaki-stonewashed



## Schlapphut

mit 2 Seitentaschen

Material: 100 % Baumwolle/Cotton

Größen/Sizes: S

Fisher hat

2 side pockets





10703B  
oliv/OD green



**Buschhut (Schlapphut)**

mit Kinnband, zum seitlichen Hochstellen, mit Druckknopf

Material: 65 % Polyester,  
35 % Baumwolle/Cotton

Größen/Sizes: 55, 57, 59, 61

**Bush hat**

chin strap, to raise on the side, press button



10703A  
schwarz/black



10703F  
khaki



10703T  
woodland



10703V  
flecktarn/BW camo



10703Y  
BW tropentarn/BW tropical camo



10703Z  
3 Farben desert/3 colour desert



# Kopfbedeckungen



10713B  
oliv/OD green

**ORIGINAL MILSPEC**



10713A  
schwarz/black



10713C  
tiger stripe



10713E  
hunter-snow



10713F  
khaki



10713G  
hunter-braun/hunter-brown



10713H  
hunter-grün/hunter-green



10713I  
CCE camo



10713J  
Typ 95 CZ farn/CZ camo



10713K  
night-camo



10713L  
vegetato



10713M  
vegetato desert



10713N  
snow tarr/snow camo



10713Q  
AT-digital



10713R  
coyote tan



10713S  
digital-woodland



10713T  
woodland



10713U  
urban



10713V  
flecktarn/BW camo



10713W  
6 Farben desert/6 colour desert



10713Y  
BW tropentarn/BW tropical camo



10713Z  
3 Farben desert/3 colour desert

## US GI Buschhut

altbewährter Tropenhut der US Army,  
Rip Stop, mit Luftlöchern und Nylonband  
Material: 100 % Baumwolle/Cotton  
Größen/Sizes: S, M, L, XL

## US GI Bush hat

well-tried tropical hat of the US Army, rip stop,  
screened side vents, branch loops, chin strap





**10723B**  
oliv/OD green

### USMC Buschhut

altbewährte Tropenhut der US Army, mit Luftlöchern und Nylonband und gesticktem US Marines Emblem, Rip Stop

Material: 100 % Baumwolle/Cotton

Größen/Sizes: S, M, L, XL

### USMC Bush hat

well-tried tropical hat of the US Army, with air vents and nylon band, embroidered US Marines emblem, rip stop



**10723F**  
khaki  
Größen/Sizes: S, L



**10723T**  
woodland



**10723Z**  
3 Farben desert/3 colour desert



**10734B**  
oliv/OD green



**10734A**  
schwarz/black



**10734F**  
khaki

### Jungle-Hut, Microfaser, FoxOutdoor

größenverstellbar, Kinnzugband, Klettverschluss zum seitlichen Hochstellen

Material: 100 % Polyester

Größen/Sizes: Einheitsgröße/one size fits all

### Jungle hat, microfiber, FoxOutdoor

adjustable in size, chin strap, velcro for sideways adjustment in height



# Kopfbedeckungen



**10763**  
**Strohhut**  
 mit Hutband, braun  
 Material: 100 % Papier/Paper  
 Größen/Sizes: Einheitsgröße/one size fits all  
**Strawhat**  
 with hat strap, brown



**10773**  
**Strohhut**  
 mit Kinnband, hellbraun  
 Material: 100 % Papier/Paper  
 Größen/Sizes: Einheitsgröße/one size fits all  
**Strawhat**  
 with chin strap, light brown



**10793**  
**Panamahut**  
 mit breiter Krempe, weiß, schwarzes Ripsband  
 Material: 100 % Papierstroh/Paper-straw  
 Größen/Sizes: Einheitsgröße/one size fits all  
**Panamahat**  
 broad-brimmed, white, black corded ribbon



**10823**  
**Playershut**  
 schmale Krempe, schwarz, weiß-schwarzes Band  
 Material: 100 % Papierstroh/Paper-straw  
 Größen/Sizes: Einheitsgröße/one size fits all  
**Playershat**  
 thin-brimmed, black, white-black corded ribbon



**10813**  
**Playershut**  
 schmale Krempe, schwarz, rotes Band  
 Material: 100 % Papierstroh/Paper-straw  
 Größen/Sizes: Einheitsgröße/one size fits all  
**Playershat**  
 thin-brimmed, black, red corded ribbon





10853G  
blau/blue



10853A  
schwarz/black



10853B  
oliv/OD green

Rollmütze, Fleece, Thinsulatefütterung

Material: 100 % Polyester  
Futter/Lining: 100 % 3M-Thinsulate  
Größen/Sizes: Einheitsgröße/one size fits all  
Fleece roll hat, Thinsulate lining



Rollmütze, Fleece

orange Thinsulatefütterung  
Material: 100 % Acryl  
Größen/Sizes: Einheitsgröße/one size fits all  
Fleece roll hat  
orange Thinsulate lining



10854G  
hunterbraun/hunterbrown



10854E  
huntersnow



10873M  
grau/grey



10873A  
schwarz/black



10873B  
oliv/OD green

Jeep-Cap, „Arctic“

Material: 100 % Acryl  
Größen/Sizes: Einheitsgröße/one size fits all  
Jeep-Cap, „Arctic“



US Jeep-Cap, Acryl

Material: 100 % Acryl  
Größen/Sizes: Einheitsgröße/one size fits all  
US Jeep-Cap, acrylic



10883A  
schwarz/black



10883B  
oliv/OD green

# Kopfbedeckungen

## Rollmütze, grob gestrickt

Material: 100 % Acryl  
Größen/Sizes: Einheitsgröße/one size fits all  
Watch Cap, knitted



10913A  
schwarz/black



10913G  
blau/blue



10913B  
oliv/OD green



10923A  
schwarz/black



10923B  
oliv/OD green



10923G  
blau/blue



## Rollmütze, fein gestrickt

Material: 100 % Acryl  
Größen/Sizes: Einheitsgröße/one size fits all  
Watch cap, fine knitted



## 10924A

### Rollmütze, kurz

schwarz, fein gestrickt  
Material: 100 % Acryl  
Größen/Sizes: Einheitsgröße/one size fits all  
Watch cap, extra short  
black, fine knitted



## 10925A

### Strickmütze, „BEANIE“

schwarz, fein gestrickt, extra kurz  
Material: 100 % Acryl  
Größen/Sizes: Einheitsgröße/one size fits all  
Knitted hat, „BEANIE“  
black, fine knitted, extra short



## 10926A

### Strickmütze, „BEANIE“

schwarz, Rip, gestrickt, extra kurz  
Material: 100 % Acryl  
Größen/Sizes: Einheitsgröße/one size fits all  
Knitted hat, „BEANIE“  
black, rip, knitted, extra short







**10929A**  
**Strickmütze, „Beanie Arctic“**  
 fein gestrickt, schwarz  
 Material: 55 % Baumwolle/Cotton, 45 % Acryl  
 Größen/Sizes: Einheitsgröße/one size fits all  
**Watch Cap, „Beanie Arctic“**  
 fine knitted, black



**10927A**  
**Strickmütze, „BEANIE“**  
 schwarz, grobe Baumwolle, kurz  
 Material: 100 % Baumwolle/Cotton  
 Größen/Sizes: Einheitsgröße/one size fits all  
**Knitted hat, „BEANIE“**  
 black, cotton, extra short



**10930A**  
**Rollmütze, „Security“**  
 silber bestickt, fein gestrickt, schwarz  
 Material: 100 % Acryl  
 Größen/Sizes: Einheitsgröße/one size fits all  
**Knitted hat, „Security“**  
 silvery embroidery, fine knitted, black



**Rollmütze, fein gestrickt**  
 Material: 100 % Wolle/Wool  
 Größen/Sizes: Einheitsgröße/one size fits all  
**Knitted hat, fine knitted**



**10933A**  
 schwarz/black



**10933B**  
 oliv/OD green



**10933G**  
 blau/blue



**10953T**  
**Rollmütze**  
 tarn-schwarz, fein gestrickt  
 Material: 100 % Acryl  
 Größen/Sizes: Einheitsgröße/one size fits all  
**Watch cap**  
 camo-black, fine knitted





**10963A**  
schwarz/black



**10963G**  
blau/blue

**Rollmütze, fein gestrickt**

kurz

Material: 100 % Acryl

Größen/Sizes: Einheitsgröße/one size fits all

**Watch Cap, fine knitted**

extra short



**10963B**  
oliv/OD green



**10973A**

**Rollmütze, „Arctic“**

gerippt, mit Thinsulate, schwarz

Material: 100 % Acryl

Futter/Lining: 100 % 3M-Thinsulate

Größen/Sizes: Einheitsgröße/one size fits all

**Watch Cap, „Arctic“**

ribbed, with Thinsulate, black



**10985A**

**Rollmütze, „Alaska“**

Thinsulate, grob gestrickt, schwarz

Material/Outer: 100 % Acryl

Innen/Inside: 100 % Polyester

Futter/Lining: 100 % 3M-Thinsulate

Größen/Sizes: Einheitsgröße/one size fits all

**Watch Cap, „Alaska“**

Thinsulate, knitted, black



**10983R**  
anthrazit/anthracite



**10983A**  
schwarz/black



**10983B**  
oliv/OD green



**10983G**  
blau/blue



**10983M**  
grau/grey

**Rollmütze, gestrickt**

kurz, Thinsulate gefüttert

Material/Outer: 100 % Acryl

Innen/Inside: 100 % Polyester

Futter/Lining: 100 % 3M-Thinsulate

Größen/Sizes: Einheitsgröße/one size fits all

**Watch Cap, knitted**

short, Thinsulate lining



**10893B**  
oliv/OD green

**Balaclava, 1 Loch**

**Material:** 100 % Acryl  
**Größen/Sizes:** Einheitsgröße/one size fits all  
**Balaclava, 1 hole**



**10893A**  
schwarz/black



**10903A**  
schwarz/black

**Balaclava, 3 Loch**

**Material:** 100 % Acryl  
**Größen/Sizes:** Einheitsgröße/one size fits all  
**Balaclava, 3 hole**



**10903B**  
oliv/OD green



**10898A**  
**Balaclava, Schlitz, dünn, schwarz**  
**Material:** 100 % Elasthan  
**Größen/Sizes:** Einheitsgröße/one size fits all  
**Balaclava, slit, thin, black**



**10899A**  
**Balaclava, 3-Loch, dünn, schwarz**  
**Material:** 100 % Elasthan  
**Größen/Sizes:** Einheitsgröße/one size fits all  
**Balaclava, 3-hole, thin, black**



**10900A**  
**Balaclava, 1-Loch, dünn, schwarz**  
**Material:** 100 % Elasthan  
**Größen/Sizes:** Einheitsgröße/one size fits all  
**Balaclava, 1-hole, thin, black**



**10905A**  
**Balaclava, 3 Loch**  
schwarz, grob gestrickt, mit Thinsulatefütterung  
**Material:** 100 % Acryl  
**Größen/Sizes:** Einheitsgröße/one size fits all  
**Balaclava, 3 hole**  
black, knitted, thinsulate lining





**10901A**  
schwarz/black



**10901B**  
oliv/OD green



**10901J**  
CZ tarn/CZ camo



**10901L**  
weiß/white



**10901Q**  
AT-digital



**10901R**  
coyote tan



**10901T**  
woodland



**10901V**  
flecktarn/BW camo



**10901Z**  
3 Farben desert/  
3 colour desert

**Balaclava, 3-Loch, dünn**

**Material:** 100 % Baumwolle/Cotton  
**Größen/Sizes:** Einheitsgröße/one size fits all

**Balaclava, 3-hole, thin**



**10908A**  
schwarz/black



**10908B**  
oliv/OD green

**Balaclava, 1-Loch**

**Material:** 100 % Polyester-Fleece  
**Größen/Sizes:** Einheitsgröße/one size fits all

**Balaclava, 1-hole**

**Balaclava, 1-Loch, dünn**

**Material:** 100 % Baumwolle/Cotton  
**Größen/Sizes:** Einheitsgröße/one size fits all

**Balaclava, 1-hole, thin**



**10902A**  
schwarz/black



**10902B**  
oliv/OD green



**27653**

**Gesichtsschutz-Maske, „Neopren“**

schwarz, aus Spezialschaum, mit Klettverschluss

**Material:** 100 % Polyester  
**Größen/Sizes:** Einheitsgröße/one size fits all

**Face mask, „Neopren“**

black, with velcro

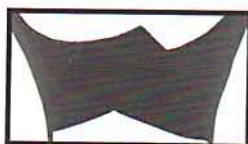

mit Klettverschluss!

**27655**

**Thermo-Kälteschutzmaske**

schwarz, winddicht, extrem leicht

**Material:** 100 % Polyester  
**Größen/Sizes:** Einheitsgröße/one size fits all

**Thermal face mask**

black, windproof, light





10615B  
oliv/OD green



10615A  
schwarz/black



10620B  
oliv/OD green



10620A  
schwarz/black

**Gesichtsschutzmaske, „Paintball“**

Kunststoff-Vollschutzmaske,  
mit Gitter im Augenbereich

Material: 100 % Polypropylen

Größen/Sizes: Einheitsgröße/one size fits all

**Visual protection mask, „Paintball“**

artificial complete protective mask,  
with grid in the eye area

**Gesichtsschutzmaske, „Airsoft“**

elastische Haltebänder, größenverstellbar per Klett,  
Metallgittereinsatz, Netzfutter innen

Material: Nylon, Metall

Größen/Sizes: Einheitsgröße/one size fits all

**Visual protection mask, „Airsoft“**

elastic holder band, size adjustable per velcro,  
metal grid, mesh lining inside



# Kopfbedeckungen

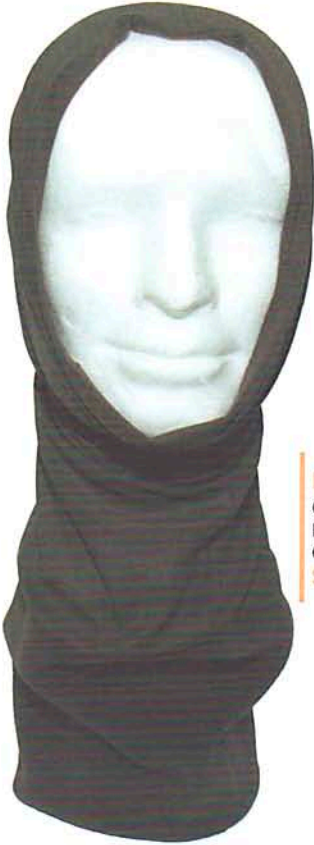

10171A schwarz/black



10171B oliv/OD green



10173A schwarz/black



10173B oliv/OD green

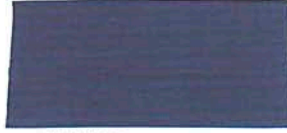

10173G navyblau/navy



## Rundschal, Fleece

Oberteil/Upperpart: 100 % Acryl-Spandex  
 Halsteil/Neckpart: 100 % Polyester  
 Größen/Sizes: Einheitsgröße/one size fits all

## Scarf, fleece

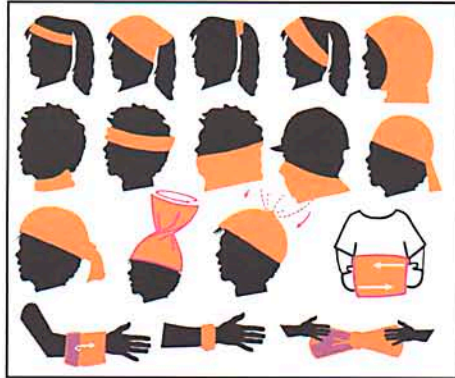

multifunktional verwendbar!

10173L weiß/white

## Rundschal

Material: 100 % Acryl-Spandex  
 Größen/Sizes: Einheitsgröße/one size fits all

## Scarf



10175I vegetato



10175T woodland



10175Q AT-digital

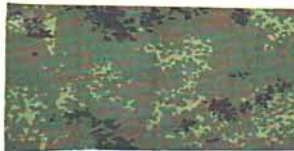

10175V flecktarn/BW camo

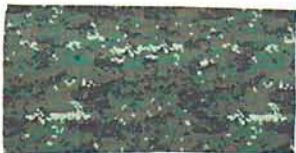

10175S digital woodland



10175X digital skyblue

## Rundschal

Material: 100 % Polyester  
 Größen/Sizes: Einheitsgröße/one size fits all

## Scarf





11063

**BW Unterhemd**

halbarm, oliv  
 Material: 100 % Baumwolle/Cotton  
 Größen/Sizes: 4, 5, 6, 7, 8  
**BW undershirt**  
 short sleeve, OD green

11064

Größen/Sizes: 9, 10



11071

**BW Unterhose**

lang, oliv  
 Material: 100 % Baumwolle/Cotton  
 Größen/Sizes: 4, 5, 6, 7, 8  
**BW long-johns**  
 long, OD green

11072

Größen/Sizes: 9

11113

**BW Plüschunterhose**

oliv, Mod.  
 Material: 100 % Baumwolle/Cotton  
 Größen/Sizes: 5, 6, 7, 8, 9, 10  
**BW long johns, freeze**  
 OD green, mod.



11123

**BW Plüschunterhemd**

oliv, Mod.  
 Material: 100 % Baumwolle/Cotton  
 Größen/Sizes: 5, 6, 7, 8, 9, 10  
**BW undershirt, freeze**  
 OD green, mod.



11253B

**BW Rollkragenhemd, Mod.**

oliv, mit Reißverschluss  
 Material: 100 % Baumwolle/Cotton  
 Größen/Sizes: 5, 6, 7, 8, 9  
**BW tricot shirt, mod.**  
 OD green, with zipper

11293B

**BW Plüsch-Rollkragenhemd**

oliv, angerauht, Mod., mit Reißverschluss  
 Material: 100 % Baumwolle/Cotton  
 Größen/Sizes: 5, 6, 7, 8, 9, 10  
**BW undershirt**  
 OD green, mod., with zipper





**13071**

**BW Stiefelsocke**

oliv, Bundeswehr-Wintersocke, mit Frotteesohle und Keilferse, waschmaschinenfest

**Material:** 70 % Schurwolle/New Wool  
30 % Polyamid

**Größen/Sizes:** 39/41, 42/44, 45/47

**BW army-socks**

OD green, winter sock, with terry cloth sole and wedge heel, machine-washable



**13091B**

**Army Socke**

oliv, 3-er Pack, waschmaschinenfest, mit Plüschsohle, verstärkte Ferse, guter Sitz, weiche Naht

**Material:** 50 % Wolle/Wool  
40 % Polyacryl  
10 % Polyamid

**Größen/Sizes:** 39/42, 43/46, 47/49

**Army-socks**

OD green, 3 pairs in 1 pack, mashine-washable, with plush sole, reinforced heel, fits well, soft seam



**13081M**

**BW Socken, Keilferse**

bewährte Bundeswehrsocke für Beruf und Freizeit, waschmaschinenfest, guter Sitz, grau

**Material:** 60 % Wolle/Wool  
40 % Polyamid

**Größen/Sizes:** 39/40, 41/42, 43/44, 45/46, 47/48

**BW socks**

approved Bundeswehr-sock for work and free time, machine-washable, fits good, grey



**13153**

**BW Socken, Keilferse**

grau, kurze Form

**Material:** 60 % Wolle/Wool  
40 % Polyester

**Größen/Sizes:** 39/40, 41/42, 43/44, 45/46

**BW socks**

grey, short

**Socken, „Extrawarm“**

Gesundheitssocke aus Vollplüsch, waschmaschinenfest, angenehmer Tragekomfort, guter Sitz

**Material:** 70 % Wolle/Wool  
30 % Polyester

**Außen/Outside:** 100 % Polyamid

**Größen/Sizes:** 39/41, 42/44, 45/47

**Socks, „Extrawarm“**

health sock made of full terry cloth, machine-washable, comfortable to wear, fits well



**13653B**  
oliv/OD green



**13653M**  
grau/grey





13313

**Trekkingsocken, „Lusen“**

oliv, Frotteesohle, eingearbeitetes Kanalsystem zur schnelleren Verdunstung der Feuchtigkeit, gepolsterte Ferse und Sohle, hoher Tragekomfort, eingearbeitete Mittelfußstütze

Material: 57 % Polyester, 31 % Baumwolle/Cotton  
7 % Nylon, 5 % Elasthan

Größen/Sizes: 39/41, 42/44, 45/47

**Trekkingsocks, „Lusen“**

OD green, integrated channel system for fast evaporation of the humidity, padded heel and foot, high wear comfort, integrated midfoot support

**Fox<sup>®</sup>**  
Outdoor



13413

**Trekkingsocken, „Arber“**

oliv, gepolsterte Sohle, Funktionssocke, hoher Tragekomfort, fußschonendes Klima durch die Coolmax-Mischung

Material: 40 % Coolmax, 40 % Baumwolle/Cotton  
17 % Nylon, 3 % Elasthan

Größen/Sizes: 39/41, 42/44, 45/47

**Trekkingsocks, „Arber“**

OD green, functional socks, high wear comfort, gentle foot environment through coolmax-mixture

13513

**Wintersocken, „Polar“**

oliv-weiß, extra hoher Schaft, kräftige Schlingenpolsterung, eingearbeitete Mittelfußstütze,

Thermolite-Fasern sorgen für warme und trockene Füße

Material: 80 % Thermolite,  
15 % Nylon, 5 % Elasthan

Größen/Sizes: 39/41, 42/44, 45/47

**Wintersocks, „Polar“**

OD green-white, extra high sock leg, strong loop paddings, integrated midfoot support,

Thermolite fibers for warm and dry feet



**BW Lederhandschuhe**

gefüttert, Mod.  
 Material: 100 % Leder/Leather  
 Futter/Lining: 100 % Acryl  
 Größen/Sizes: S, M, L, XL, XXL  
**BW leather gloves**  
 lined, mod.



15061A  
 schwarz/black



15061M  
 grau/grey



15253F  
 beige



15253A  
 schwarz/black

**Western-Fingerhandschuhe**

Leder, mit Bandzug, gefüttert  
 Material: 100 % Leder/Leather  
 Futter/Lining: 100 % Acryl  
 Größen/Sizes: S, M, L, XL, XXL  
**Country-gloves**  
 leather, with cord, lined



15503  
**Lederhandschuhe**  
 ohne Finger, mit Nieten, schwarz  
 Material: 100 % Leder/Leather  
 Größen/Sizes: S, M, L, XL, XXL  
**Leather cycle gloves**  
 with rivets, fingerless, black

15513

**Lederhandschuhe**  
 ohne Finger, ohne Nieten, schwarz  
 Material: 100 % Leder/Leather  
 Größen/Sizes: S, M, L, XL, XXL  
**Leather cycle gloves**  
 fingerless, black





**15301V**  
flecktarn/BW camo



**15301A**  
schwarz/black



**15301B**  
oliv/OD green

### Fleece-Fingerhandschuhe „Alpin“

winddicht, atmungsaktiv, wasserabweisend,  
Innenhandbesatz PVC-beschichtet

Außenmaterial/Outer shell: 100 % Polyester-Fleece

Innenmaterial/Inside: 100 % Polyester

Größen/Sizes: S, M, L, XL, XXL, XXXL

### Fleece-gloves „Alpin“

windproof, breathable, waterproof,  
glove inside with PVC-coated trimming

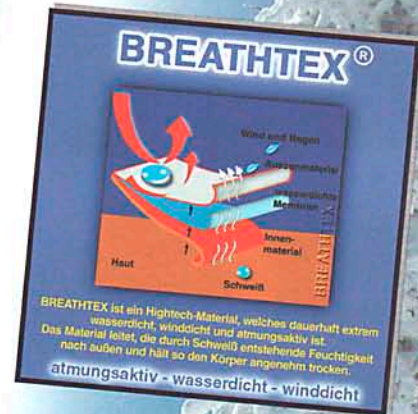

**15403B**  
oliv/OD green



**15403A**  
schwarz/black

### Fleece-Fingerhandschuhe

mit Thinsulatefütterung

Außenmaterial/Outer shell: 100 % Polyester-Fleece

Innenmaterial/Inside: 100 % Polyester

Futter/Lining: 100 % 3M-Thinsulate

Größen/Sizes: S, M, L, XL, XXL

### Fleece-gloves

with thinsulate lining



**15423E**  
hunter-snow



**15423G**  
hunter-braun/hunter-brown

### Polarfleece-Fingerhandschuhe

Thinsulatefütterung, geräuschlos, wasserdicht,  
winddicht, 3 Lagen Laminat

Material: 100 % Polyester-Polarfleece

Futter/Lining: 100 % 3M-Thinsulate

Größen/Sizes: S, M, L, XL, XXL

### Polarfleece-gloves

Thinsulate padded, noiseless, waterproof, windproof,  
3 layer membran



15443A  
schwarz/black



15443B  
oliv/OD green

**Strick-Fingerhandschuhe**

Material: 100 % Acryl  
Größen/Sizes: S/M, L/XL  
Gloves, knitted



15453A

**Strick-Handschuhe, ohne Finger**

schwarz  
Material: 100 % Acryl  
Größen/Sizes: S, M, L, XL  
Knitted gloves, fingerless  
black



15455A

**Strick-Handschuhe**

schwarz, mit Thinsulatefütterung,  
ohne Finger  
Material: 100 % Acryl  
Futter/Lining: 100 % 3M-Thinsulate  
Größen/Sizes: S, M, L, XL  
Knitted-gloves  
black, with thinsulate lining, fingerless



15483A

**Strickhandschuhe, „Extreme“**

schwarz, Thinsulatefütterung  
Außenmaterial/Outer shell: 100 % Acryl  
Innenmaterial/Inside: 100 % Polyester  
Futter/Lining: 100 % 3M Thinsulate  
Größen/Sizes: S, M, L, XL, XXL  
Gloves, „Extreme“  
black, with thinsulate lining





15457A  
schwarz/black

**Strick-Handschuhe**

mit Thinsulatefütterung, ohne Finger, zugleich Fausthandschuh, Handinnenfläche mit Lederbesatz

Material: 100 % Acryl  
Futter/Lining: 100 % 3M-Thinsulate  
Größen/Sizes: S, M, L, XL

**Knitted-gloves, mittens**

with thinsulate lining, fingerless, glove insides with leather trimming



15457B  
oliv/OD green



15473B  
oliv/OD green



15473V  
flecktarn/BW camo



15473A  
schwarz/black

**Fingerhandschuhe, Thinsulate**

mit Strickbund, Innenfläche PVC  
Außenmaterial/Outer shell: 65 % Polyester, 35 % Baumwolle/Cotton  
Innenmaterial/Inside: 100 % Polyester  
Futter/Lining: 100 % 3M-Thinsulate/Polyester  
Größen/Sizes: S, M, L, XL, XXL, XXXL

**Gloves, thinsulate**

with knitted waistband, inside PVC



15493A  
schwarz/black

**Fingerstrickhandschuhe**

mit Thinsulate-Fütterung  
Außenmaterial/Outer shell: 100 % Acryl  
Innenmaterial/Inside: 100 % Polyester  
Futter/Lining: 100 % 3M-Thinsulate  
Größen/Sizes: S, M, L, XL

**Knitted gloves**  
with thinsulate lining



15493B  
oliv/OD green



**15610**  
**Lederhandschuhe**  
 schwarz, mit schnitthemmender KEVLAR®-Einlage  
 Material: 100 % Leder/Leather  
 Größen/Sizes: XS, S, M, L, XL, XXL  
**Leather gloves**  
 black, cut resisting kevlar®-inlays



**15615**  
**Lederhandschuhe**  
 schwarz, mit Quarzsandfüllung  
 Material: 100 % Leder/Leather  
 Größen/Sizes: S, M, L, XL, XXL  
**Leather gloves**  
 black, with silica sand filling



**15620**  
**Lederhandschuhe**  
 schwarz, mit Polsterung und Wildlederverstärkung  
 Material: 100 % Leder/Leather  
 Größen/Sizes: S, M, L, XL, XXL  
**Leather gloves**  
 black, padding, buckskin reinforcement



**15803B**  
 oliv/OD green



**15803A**  
 schwarz/black

**Neopren Fingerhandschuhe**  
 ultradünn, aus Allwetter-Neopren,  
 mit Synthetic-Leder-Handfläche,  
 mit elastischem Klettverschluss  
 Material: 100 % Neopren  
 Größen/Sizes: S, M, L, XL, XXL  
**Neoprene gloves**  
 ultra thin, all weather neoprene,  
 synthetic leather palm, elastic cuff with  
 velcro fastener



**15853A**  
**Fingerhandschuhe, „SECURITY“**  
 Neopren, Schnitenschutz, schwarz, hochwertiger  
 Security-Handschuh, Handinnenfläche aus  
 Synthetik-Leder, Handaußenseite aus Stretch-  
 Spandex und Neopren, elastisches Verstellband  
 am Handgelenk mit Klett  
 Größen/Sizes: S, M, L, XL, XXL  
**Gloves, „SECURITY“**  
 black, cut protection, hand inside of synthetics-  
 leather, hand outside of stretch-spandex and  
 neoprene, elastic belt at the wrist with velcro



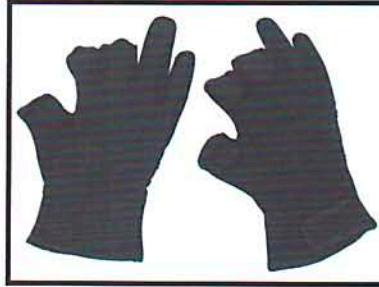

15873A

**Fingerhandschuhe, „Combat“**

schwarz, hochwertiger Security-Handschuh, Neopren, Fingerkuppe zurückklappbar, Verstellband am Handgelenk mit Klett

Material: 90 % Neopren, 5 % Nylon, 5 % Polyester

Größen/Sizes: S, M, L, XL, XXL

**Gloves, „Combat“**

black, high-quality security-glove, neoprene, back hinged fingertips, elastic belt at the wrist with velcro



15883A

**Fingerhandschuhe, „Mesh“**

schwarz, hochwertiger Security-Handschuh, Neopren, Fingerkuppe zurückklappbar, elastisches Verstellband am Handgelenk mit Klett

Material: 60 % Neopren, 20 % Nylon, 20 % Polyester

Größen/Sizes: S, M, L, XL, XXL

**Gloves, „Mesh“**

neoprene, black, high-quality security-glove, back hinged fingertips, elastic belt at the wrist with velcro



16053

**Magisches Tuch**

weiß, Microfaser, 5 Stück im Beutel,  
Größe: 4,5 x 1,5 cm,  
entfaltete Größe: 23 x 23 cm  
Material: 80 % Polyester, 20 % Polyamid

**Magic towel**

white, microfabric, 5 pcs in polybag,  
size: 4,5 x 1,5 cm,  
size open: 23 x 23 cm



16013

**Microfasertuch**

im Netzbeutel, mit Karabiner, oliv  
Material: 80 % Polyester, 20 % Polyamid  
Größe/Size: 40 x 40 cm

**Microfibre cloth**

netbag, with carabiner, OD green



16123B  
oliv/OD green



16123A  
schwarz/black



16123G  
blau/blue

**Fleece-Schal**

Material: 100 % Polyester  
Größe/Size: 160 x 25 cm

**Fleece scarf**



16163M

**Strickschal**

grau, fein gestrickt, mit Fransen  
Material: 100 % Acryl  
Größe/Size: 150 x 24 cm

**Knitted scarf**

grey, fine knitted, with fringes



16153Q

**Strickschal**

natur, grob gestrickt, mit Fransen  
Material: 100 % Acryl  
Größe/Size: 160 x 20 cm

**Knitted scarf**

nature, knitted, with fringes

**Sniper Schal**

Material: 100 % Polyamid  
Größe/Size: 160 x 70 cm

**Sniper scarf**



16301A  
schwarz/black



16301R  
coyote tan



16301B  
oliv/OD green





**16303V**  
flecktarn/BW camo



**16303A**  
schwarz/black



**16303B**  
oliv/OD green



**16303J**  
CZ tarn/CZ camo



**16303T**  
woodland



**16303Y**  
BW tropentarn/BW tropical camo

**Netzschal**

Material: 100 % Baumwolle/Cotton  
Größe/Size: 190 x 90 cm  
**Net scarf**



**16603A**  
schwarz/black



**16603L**  
weiß/white

**Bein-Save**

praktischer Beinsave für Wertgegenstände,  
mit Klettverschluss

Material: 100 % Elastan

**Leg save**

funktional legsafe for valuable goods,  
with velcro

**16093**

**BW Taschentuch**

3-er Pack

Material: 100 % Baumwolle/Cotton

Größe/Size: 50 x 50 cm

**BW handkerchief**

3 pcs/pack





16403T  
woodland



16403A  
schwarz-weiß/black-white



16403B  
oliv-schwarz/OD green-black



16403C  
tiger stripe



16403D  
burgund-schwarz/burgundy-black



16403F  
beige-schwarz/beige-black



16403H  
royalblau-weiß/royal-white



**Bandana**

**Material:** 100 % Baumwolle/Cotton  
**Größe/Size:** ca. 55 x 55 cm

**Bandana**



16403I  
rot-weiß/red-white



16403L  
weiß-schwarz/white-black



16403M  
grau-schwarz/grey-black



16403Q  
USA Fahne/USA flag



16403R  
Stars und Stripes



16403U  
urban



16401A  
**Bandana, „Totenkopf“**  
schwarz-weiß, mit Totenkopf  
**Material:** 100 % Baumwolle/Cotton  
**Größe/Size:** 55 x 55 cm  
**Bandana, „Skull“**  
black-white, with skull





**16503A**  
schwarz-weiß/black-white



**16503B**  
oliv-schwarz/OD green-black



**16503F**  
sand-schwarz/sand-black



**16503G**  
blau-weiß/blue-white



**16503I**  
rot-weiß/red-white

**PLO-Tuch**

mit Fransen

Material: 100 % Baumwolle/Cotton

Größe/Size: ca. 115 x 110 cm

**Shemagh**

fringed



**16513B**

**PLO Tuch**

mit Fransen, oliv-schwarz, mit Totenkopf

Material: 100 % Baumwolle/Cotton

Größe/Size: 100 x 100 cm

**Shemagh**

fringed, OD green-black, with skull





17011V  
flecktarn/BW camo



17011T  
woodland



17011Y  
BW tropentarn/BW tropical camo

**Kinder-T-Shirt**

halbarm

Material: 100 % Baumwolle/Cotton

Größen/Sizes: 122/128, 134/140, 146/152, 158/164, 170/176

**Kids T-Shirts**

short-sleeves



**Kinder-Baseball-Cap**

mit Schild, größenverstellbar

Material: 65 % Polyester, 35 % Baumwolle/Cotton

Größen/Sizes: Einheitsgröße/one size fits all

**Kids BB Cap**

visor, size adjustable



mit Plastikverschluss!



17101V  
flecktarn/BW camo



17101T  
woodland



17152T  
woodland



17152U  
urban



17152V  
flecktarn/BW camo

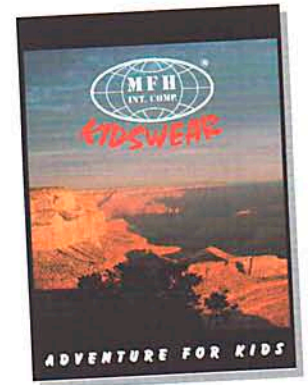

**US BDU Kinderhose**

2 seitliche Einschubtaschen, Gesäßtasche,  
2 seittl. aufgesetzte Bein-Pattentaschen,  
Bandzug am Beinende, Gummizug am Bund

Material: 65 % Polyester, 35 % Baumwolle/Cotton

Größen/Sizes: 110/116, 122/128, 134/140, 146/152, 158/164, 170/176

**US BDU pants for kids**

2 front slash pocket, back pocket, 2 cargo pockets,  
drawstring ankle ties, elastic cord at band



17203V  
flecktarn/BW camo

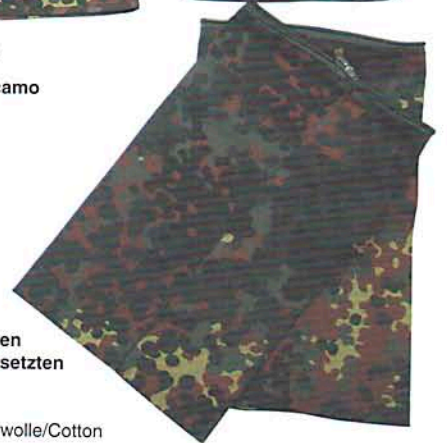

**Kinder-Anzug**

Sommerausführung, Survivalweste mit vielen  
aufgesetzten Taschen, Armyhose mit aufgesetzten  
Pattentaschen, Gummizug am Bund und  
abnehmbaren Beinen (Bermuda)

Material: 65 % Polyester, 35 % Baumwolle/Cotton

Größen/Sizes: XS, S, M, L, XL, XXL

**Kids set**

summer version, survival vest with many front  
pockets, army pants with cargo leg pockets,  
elastic cord at band and detachable legs (bermuda)



17203T  
woodland



17342A

**US Kinder-Pilotenjacke MA1**

schwarz, 2 geräumige Schubtaschen mit Druckknopfverschluss, Armbüro, Strickbündchen am Kragen und Bund, wasserabweisendes Außenmaterial

Obermaterial/Outer shell: 100 % Nylon  
 Innenmaterial/Inside material: 100 % Polyester  
 Füllung/Lining: 100 % Polyester  
 Größen/Sizes: S, M, L, XL, XXL

**US pilot jacket, MA1, kids**

black, 2 huge front slash pockets with snaps, pen/utility pocket, knitted cuffs at collar and waistband, waterproof outer shell



17352B  
 oliv/OD green



17352A  
 schwarz/black

**US Kinder-Pilotenjacke CWU**

mit Fliegerabzeichen, Kragen, 2 aufgesetzte Pattentaschen mit Klettverschluss, Armbüro, Strickbund am Ärmel und Bund

Obermaterial/Outer shell: 100 % Nylon  
 Innenmaterial/Inside material: 100 % Polyester  
 Füllung/Lining: 100 % Polyester  
 Größen/Sizes: S, M, L, XL, XXL

**US pilot jacket, CWU, kids**

with patches, flap pocket with velcro, pen/utility pocket, knitted cuffs at collar and waistband



**MFH**  
**KIDSWEAR**  
Adventure for Kids



**17372B**  
oliv/OD green



**17372A**  
schwarz/black

**US Kinder-Polarjacke, N2B**

Kapuze mit Fellkragen, abnehmbare Kapuze mit Kunstfell besetzt,  
2 Schubtaschen mit Druckknopfverschluss,  
abgedeckter Reißverschluss an der vorderen Mitte, 1 Innentasche  
Obermaterial/Outer shell: 100 % Nylon  
Innenmaterial/Inside material: 100 % Polyester  
Füllung/Lining: 100 % Polyester  
Größen/Sizes: S, M, L, XL, XXL

**US kids polar jacket, N2B**

removable hood with artificial fur, 2 thrust-in-pockets with buttons,  
covered zipper at the front middle, 1 inner pocket



**17413Y**

**US Kindersteppweste, „Ranger“**

BW tropentarn, gefüttert, mit 4 aufgesetzten Taschen, 2 seitt. Einschubtaschen, mehrere kleine Taschen, Reißverschluss, Druckknopfverschluss  
Obermaterial/Outer shell: 65 % Polyester, 35 % Baumwolle/Cotton  
Innenmaterial/Inside material: 100 % Baumwolle/Cotton  
Füllung/Lining: 100 % Polyester  
Größen/Sizes: S, M, L, XL, XXL

**US kids vest, „Ranger“**

BW tropical camo, lined, with 4 front pockets, 2 side batch pockets,  
multiple little pockets, zipper, snap

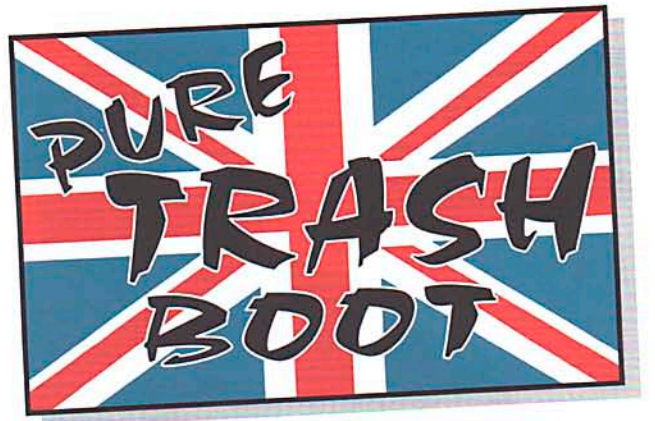

18913

**Halbschuhe, 3-Loch**

„Pure Trash“, schwarz, mit Stahlkappe u. Schrauben

Material: Leder/Leather

Sohle/Sole: Gummi/Rubber

Größen/Sizes: 3, 4, 5, 6, 7, 8, 9, 10, 11, 12, 13

**Low shoe, 3 hole**

black, with steel cap and screws



18923

**Stiefel, 10-Loch**

„Pure Trash“, schwarz, mit Stahlkappe u. Schrauben

Material: Leder/Leather

Sohle/Sole: Gummi/Rubber

Größen/Sizes: 3, 4, 5, 6, 7, 8, 9, 10, 11, 12, 13

**Boots, 10 hole**

black, with steel cap and screws



18933

**Stiefel, 14-Loch**

„Pure Trash“, schwarz, mit Stahlkappe u. Schrauben

Material: Leder/Leather

Sohle/Sole: Gummi/Rubber

Größen/Sizes: 3, 4, 5, 6, 7, 8, 9, 10, 11, 12, 13

**Boots, 14 hole**

black, with steel cap and screws

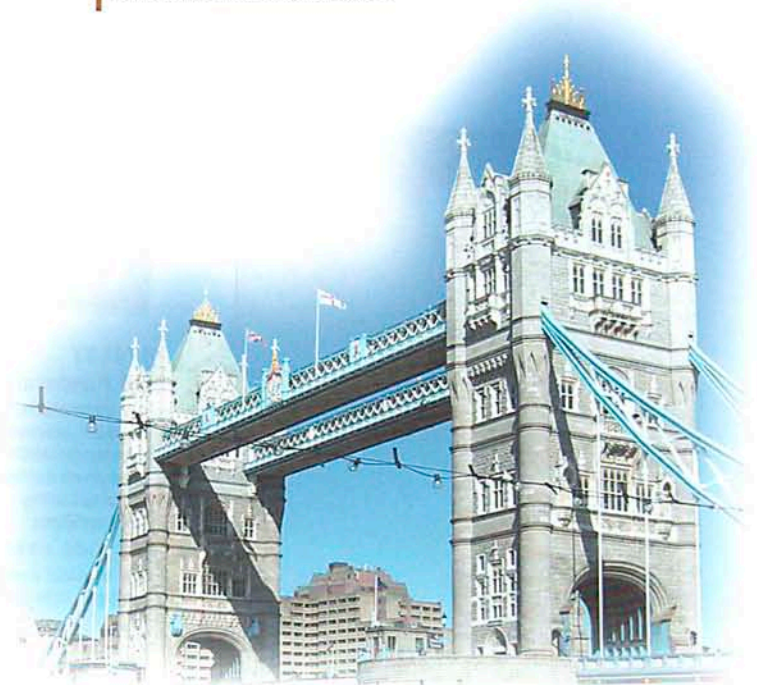





18783A

**Stiefel, Fox-Adventure**

hochwertiger Outdoorstiefel, mit Gummisohle

Material: Nylon, Leder/Leather

Sohle/Sole: Gummi/Rubber

Futter/Lining: Cambrella

Größen/Sizes: 4, 5, 6, 7, 8, 9, 10, 11, 12, 13

**Boot, Fox-Adventure**

high-quality outdoorboot, with rubber sole



18793A

**Stiefel, Fox-Adventure-DeLux**

hochwertiger Outdoorstiefel, mit Gummisohle, gefüttert mit Thinsulate, Nylonteile mit BREATHTEX-Membran gefüttert

Material: Nylon, Leder/Leather, Breathtex, Thinsulate

Sohle/Sole: Gummi/Rubber

Futter/Lining: Cambrella

Größen/Sizes: 4, 5, 6, 7, 8, 9, 10, 11, 12, 13

**Boot, Fox-Adventure-DeLux**

high-quality outdoorboot, with rubber sole, lined with thinsulate, nylonparts are lined with Breathtex-membrane



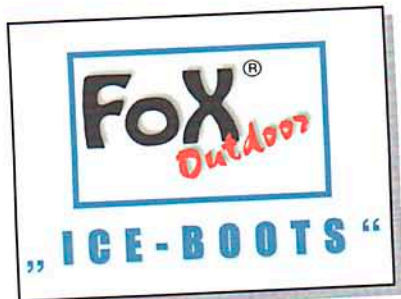

18403B  
oliv/OD green

**Kälteschutzstiefel, „Fox Ice-Boots“, 40° C**

Kälteschutzstiefel für die extremen Witterungsbedingungen, mit griffiger Gummisohle, Nylonschaft weitenverstellbar, herausnehmbare beschichtete Filzfütterung

Material: Nylon  
Sohle/Sole: Gummi/Rubber  
Futter/Lining: Filz/Felt  
Größen/Sizes: 37, 38, 39, 40, 41, 42, 43, 44, 45, 46, 47

**Thermo boots, „Fox Ice-Boots“, 40° C**

cold weather-protection boots for extreme weather, with good grip rubber sole, nylonshaft adjustable, detachable coated feltlining



18403A  
schwarz/black



18413A

**Kälteschutzstiefel, „FOX-XTREME“**

mit Gummisohle, schwarz, Kälteschutzstiefel für die extremen Witterungsbedingungen, mit griffiger Gummisohle, Nylonschaft weitenverstellbar, herausnehmbare beschichtete Filzfütterung, Thinsulatefütterung, Reflektorband an Schaftende

Material: Nylon  
Sohle/Sole: Gummi/Rubber  
Größen/Sizes: 39, 40, 41, 42, 43, 44, 45, 46, 47

**Thermo boots, „FOX-XTREME“**

rubber sole, black, cold weather-protection boots for extreme weather, with good grip rubber sole, nylonshaft adjustable, detachable coated felt lining, thinsulate lining, reflecting band at the leg

18423A

**Kälteschutzstiefel, „ABSOLUTE ZERO“**

Kälteschutzstiefel für die extremen Witterungsbedingungen, Leder-Nylonschaft, griffige Gummisohle von „Vibram“, herausnehmbare beschichtete Filzfütterung, Reflektorband an Schaft

Material: Nylon, Leder/Leather  
Sohle/Sole: Gummi/Rubber  
Größen/Sizes: 38, 39, 40, 41, 42, 43, 44, 45, 46

**Thermo boots, „ABSOLUTE ZERO“**

cold weather boots for extreme weather conditions, leather-nylon, handy rubber sole from „Vibram“, detachable coated felt lining, reflecting band at the leg





18523

**Stiefel, „Trapper“**

schwarz, mit Filzschaft, Einlegesohle aus Filz,  
Höhe ca. 33 cm

Material: PVC

Futter/Lining: Polyester, Filz/Felt

Größen/Sizes: 39, 40, 41, 42, 43, 44, 45, 46

**Boots, „Trapper“**

black, with felt, insole from felt,  
height ca. 33 cm



18503B

**Gummistiefel**

oliv, weitenverstellbarer Schaft, robuste Sohle,  
Innenfutter aus Neopren, Höhe ca. 40 cm

Material: Gummi, Neopren/Rubber, Neoprene

Größen/Sizes: 38, 39, 40, 41, 42, 43, 44, 45, 46, 47

**Rubber boot**

OD green, length adjustable shaft, robust sole,  
inner lining from neoprene, height ca. 40 cm

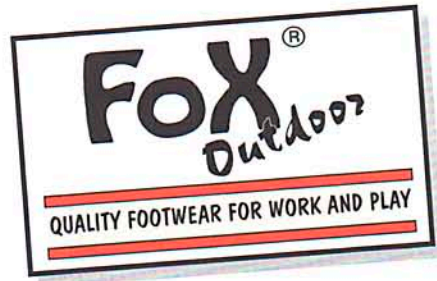

18513B

**Stiefel, Gummi-Neopren**

schwarz-oliv, leichter Stiefel mit Neopren-Einlage am Schaft,  
robuste Sohle, Fersenkeil

Material: Kautschuk, Neopren/Caoutchouc, Neoprene

Größen/Sizes: 41, 42, 43, 44, 45, 46, 47

**Boot, rubber-neoprene**

black-OD green, light boots with neopren insole at the shaft,  
robust sole, heel gusset



18135

**Kampfstiefel**

schwarz, Vollleder, gute Ausführung, mit Lederfutter

Material: Leder/Leather

Sohle/Sole: Gummi/Rubber

Größen/Sizes: 37, 38, 39, 40, 41, 42, 43, 44, 45, 46, 47, 48, 49, 50

**Combat boots**

black, grain leather, leather lining



18145

**Kampfstiefel, „Modell 2000“**

aktuelles BW Modell, aus hochwertigem Leder, sehr guter Lauf- und Tragekomfort, durchgehend ledergefütert, Belüftungslöcher am oberen Schafttrand, Dehnungsfalte im Sprunggelenksbereich, antistatische Sohle, öl- und benzinbeständig

Material: Leder/Leather

Sohle/Sole: Gummi/Rubber

Größen/Sizes: 37, 38, 39, 40, 41, 42, 43, 44, 45, 46, 47, 48

**Combat boots, „Modell 2000“**

current BW model, high-quality leather, very well motion and wearing comfort, non-stop lined with leather, air vents at the upper boot-leg, antistatic sole, oil and gasoline-resistant



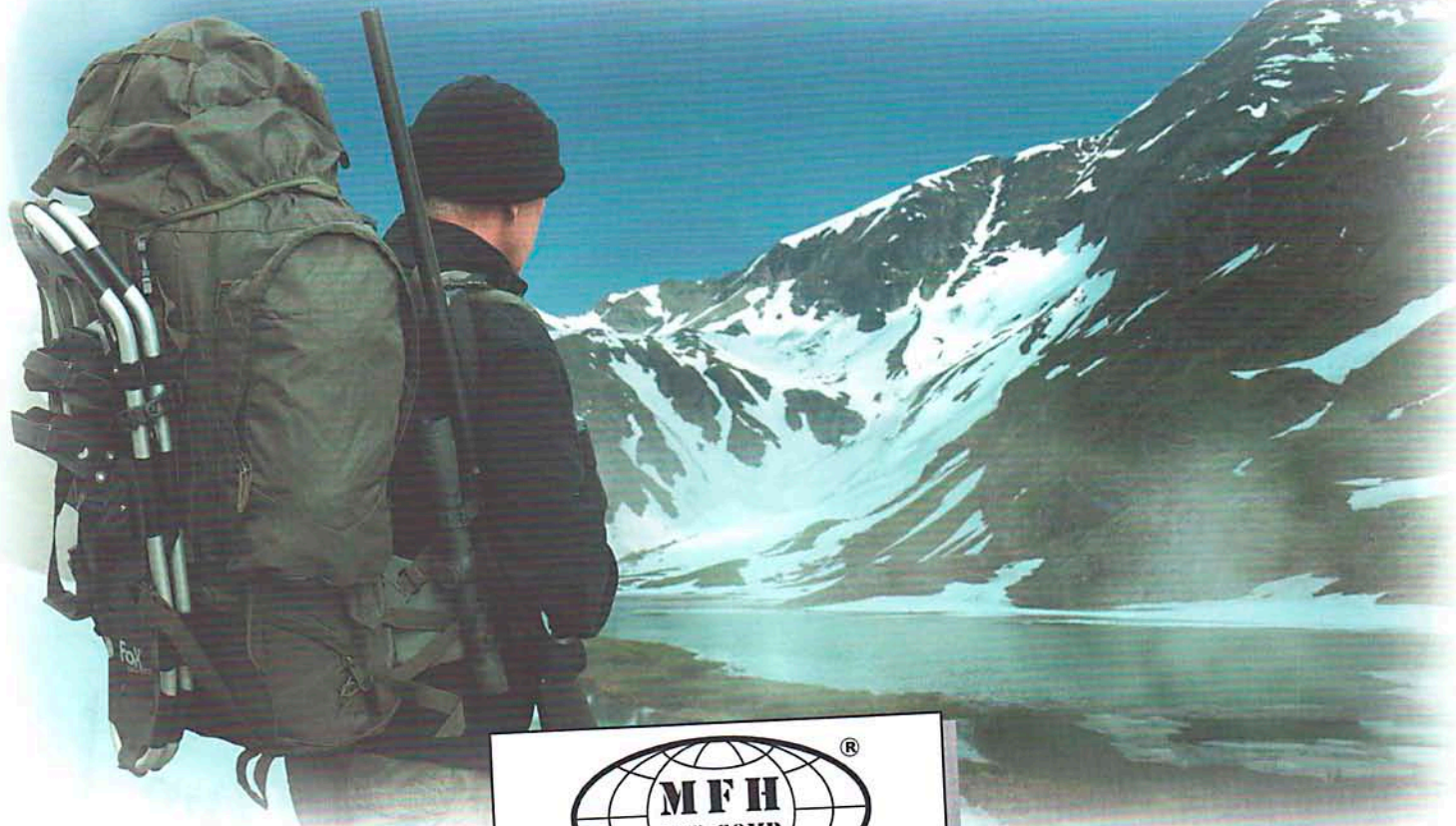

18204

**BW Bergschuh**

schwarz, Breathtex-Fütterung, Membrane, Mod.,  
gut geeignet für Outdoor und Beruf, extrem leicht und bequem,  
Schnürbandfixierung für guten Halt im Vorderfuß und Fersenbereich,  
atmungsaktiv, wasserdicht, windfest

Material: Leder/Leather  
Sohle/Sole: Gummi/Rubber  
Innenmaterial/Lining: Breathtex, Cambrella  
Größen/Sizes: 250, 255, 260, 265, 270, 275, 280, 285, 290, 295, 300, 305, 310

**BW mountain boots**

black, Breathtex-lining, membrane, mod.,  
good fitting for outdoor and work, extremely light and comfortable,  
lacing for strong hold at the forefoot- and heel area, breathable,  
waterproof, windproof



18214

**BW Bergschuh, „Modell 2005“**

schwarz, Breathtex-Fütterung, Membrane, Mod.,  
gut geeignet für Outdoor und Beruf, extrem leicht und bequem,  
Schnürbandfixierung für guten Halt im Vorderfuß und Fersenbereich,  
atmungsaktiv, wasserdicht, windfest

Material: Leder/Leather  
Sohle/Sole: Gummi/Rubber  
Innenmaterial/Lining: Breathtex, Cambrella  
Größen/Sizes: 250, 255, 260, 265, 270, 275, 280, 285, 290, 295, 300, 305

**BW mountain boots, „Modell 2005“**

black, Breathtex-lining, membrane, mod.,  
good fitting for outdoor and work, extremely light and comfortable,  
lacing for strong hold at the forefoot- and heel area, breathable,  
waterproof, windproof

18313B

**Trekking Schuh**

Kordelzug, oliv/grau

Material: PU, Nylon

Sohle/Sole: Kunststoff/Plastic

Futter/Lining: Neopren

Größen/Sizes: 40, 41, 42, 43, 44, 45, 46

**Trekking shoe**

drawstring, OD green/grey

18303Z

**Trekking Sandale**

Clipverschluss, desert

Material: PU, Leder/Leather, Nylon

Sohle/Sole: Kunststoff/Plastic

Futter/Lining: Neopren

Größen/Sizes: 40, 41, 42, 43, 44, 45, 46

**Trekking sandal**

buckle closer, desert



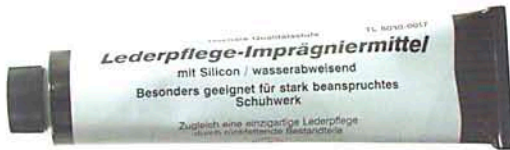

**BW Schuhcreme**  
125 ml Tube  
**BW leather dubbing**  
125 ml tube

**2021A**  
schwarz/black



**2021N**  
braun/brown



**2021Q**  
farblos/colourless



**20031**  
**Schnürsenkel**  
schwarz, Länge: 180 cm  
**Shoelaces**  
black, length: 180 cm



**20021**  
**BW Schnürsenkel**  
schwarz, für Kampfstiefel, Länge: 160 cm  
**BW shoelaces**  
black, for combat boots, length: 160 cm



**20035**  
**Schnürsenkel**  
schwarz, Länge: 110 cm  
**Shoelaces**  
black, length: 110 cm

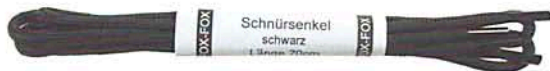

**20041A**  
schwarz/black



**20045A**  
schwarz/black



**20041I**  
rot/red



**20041L**  
weiß/white

**Schnürsenkel**  
Länge: 70 cm  
**Shoelaces**  
length: 70 cm



**20045I**  
rot/red



**20045L**  
weiß/white

**Schnürsenkel**  
Länge: 190 cm  
**Shoelaces**  
length: 190 cm



**20047A**  
schwarz/black



**20047I**  
rot/red



**20047L**  
weiß/white

**Schnürsenkel**  
Länge: 210 cm  
**Shoelaces**  
length: 210 cm

**20073**  
**Stiefel-Schnellverschluss**  
Kunstleder, 8 Ösen  
**Boots quick release fastener**  
synthetic leather, with 8 loops

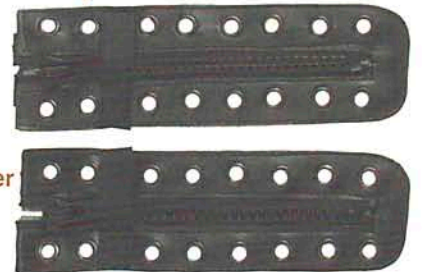



**20145**  
**BW Nässeschutzgamaschen**  
 flecktarn, atmungsaktiv, 3-Lagen-Laminat  
 Material: Nylon  
**BW gaiters**  
 BW camo, breathable, 3-layer-laminate



**20143V**  
 flecktarn/BW camo



**20143A**  
 schwarz/black

**BW Nässeschutzgamaschen**  
 mit Reißverschluss und Klettverschluss  
 Material: Nylon  
**BW gaiters**  
 with zipper and velcro



**20143B**  
 oliv/OD green



**20147**  
 woodland

**BW Gamasche**  
 mit Membran, wasserdicht, atmungsaktiv,  
 verschleißarmes Nylongewebe,  
 W.R.P. 8000 mm H<sub>2</sub>O, W.V.P. 3000 gm<sup>2</sup> Tag  
 Material: Nylon  
**BW gaiters**  
 with membrane, waterproof, breathable,  
 low-wear nylonmaterial,  
 W.R.P. 8000 mm H<sub>2</sub>O, W.V.P. 3000 gm<sup>2</sup> day



**20146**  
 oliv/OD green



**20123B**  
 oliv/OD green



**20123N**  
 braun/brown

**Nässeschutzgamaschen**  
 mit Reißverschluss, Stahldraht  
 Material: Nylon  
**Gaiters**  
 with zipper, wire



**20133B**  
 oliv/OD green

**Beinlinge**  
 lang, Reißverschluss, Gürtelschlaufe  
 Material: Nylon  
**Chausses**  
 long, with zipper, belt loop



**20133N**  
 braun/brown





22182A  
schwarz/black



22182B  
oliv/OD green



22182T  
woodland



22182V  
flecktarn/BW camo

**Hosenträger**

mit 3 Klipsen, Y-Modell, elastisch, Länge verstellbar

**Suspenders**

with 3 clips, y-model, elastic, adjustable length



22015A  
schwarz/black



22015B  
oliv/OD green



**Gürtel**

mit Klettverschluss, 3,2 cm breit

Material: 100 % Nylon

Größen/Sizes: 90, 100, 110, 120, 130, 140 cm

**Belt**

with velcro, 3,2 cm wide

**BW Hosengürtel**

mit Kastenschloß, 3 cm breit

Material: 100 % Polyester

Größen/Sizes: bis 130 cm verstellbar/adjustable until 130 cm

**BW belt**

with buckle, 3 cm wide

22055A  
schwarz/black



22055B  
oliv/OD green



22316

**Hüftgurt**

9 cm, oliv, für BW Koppeltragesystem

Größen/Sizes: 80, 90, 100 cm

**Belt for field suspender**

9 cm, OD green

22310

**Schulterriemen/Beckengurte**

für Alice Bag, gepolstert

**Belts for alice bag**

padded

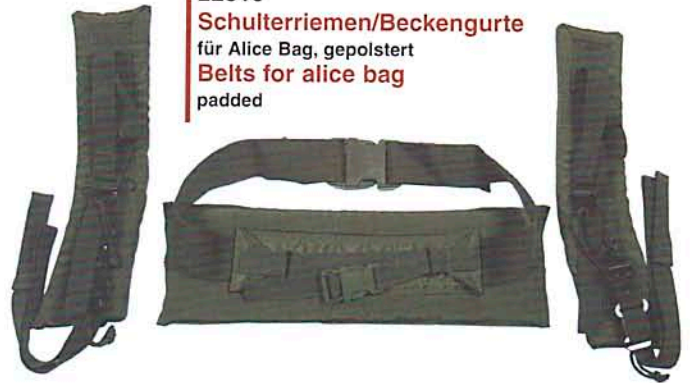



22383A  
schwarz/black



22383B  
oliv/OD green

**Koppel, „Tactical“**

mit Metallverschluss, 4 cm breit  
Material: 100 % Nylon  
Größen/Sizes: bis 120 cm verstellbar/adjustable until 120 cm  
**Belt, „Tactical“**  
metal buckle, 4 cm wide

**Koppel, „Instructor“**

Metallverschluss, 4,5 cm breit  
Material: 100 % Nylon  
Größen/Sizes: bis 105 cm verstellbar/adjustable until 105 cm  
**Reinforced instructor belt**  
with metal buckle, 4,5 cm wide

22393A  
schwarz/black



22393B  
oliv/OD green



22473A  
schwarz/black

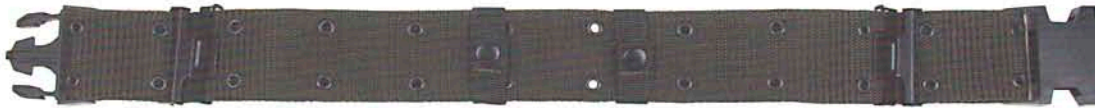

22473B  
oliv/OD green



22473T  
woodland

**US Lochkoppel**

mit Plastikverschluss, LC2  
Material: 100 % Nylon  
Größen/Sizes: bis 110 cm verstellbar/adjustable until 110 cm

**US pistol belt**

plastic buckle, LC2

**Gürtel, „Enforcement“**

Plastikverschluss  
Material: 100 % Nylon  
Größen/Sizes: bis 100 cm verstellbar/adjustable until 100 cm  
**Web belt, „Enforcement“**  
plastic closure



22601A  
schwarz/black



22601B  
oliv/OD green



22513A

**Gürtel, mit Geldfach**

schwarz, mit Chrom-Schloß, 3,2 cm breit  
Material: 100 % Polyester  
Größen/Sizes: bis 130 cm verstellbar/adjustable until 130 cm  
**Web belt with money pocket**  
black, chrome-closure, 3,2 cm wide



**Lochkoppel**

6 cm breit

Material:

Größen/Sizes:

**Pistol belt**

6 cm wide

80 % Baumwolle/Cotton, 20 % Polyester  
bis 120 cm verstellbar/adjustable until 120 cm



22403A  
schwarz/black

22403B  
oliv/OD green



22505A  
schwarz/black

22505B  
oliv/OD green

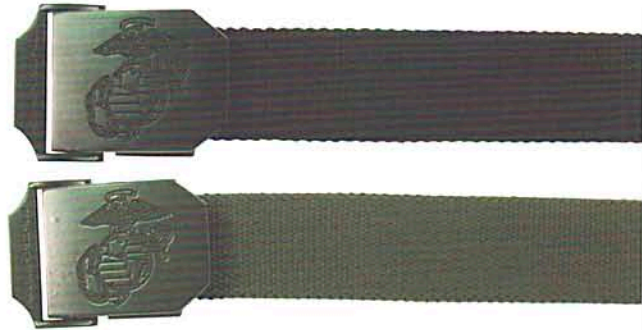

**USMC Gürtel**

35 mm breit

Material:

Größen/Sizes:

**USMC Web belt**

35 mm wide

100 % Polyester  
bis 130 cm verstellbar/adjustable until 130 cm

22533A  
schwarz/black

22533B  
oliv/OD green

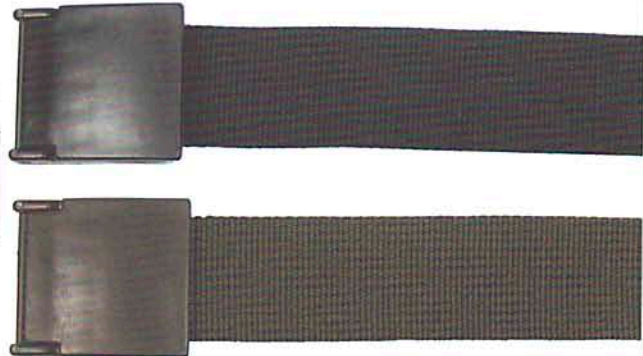

**US Gürtel, „Stealth“**

4 cm breit, mit Plastikschloß

Material:

Größen/Sizes:

**US belt, „Stealth“**

4 cm wide, with plastic buckle

100 % Polyester  
bis 130 cm verstellbar/adjustable until 130 cm

**Gürtel, mit Metallschloß**

3 cm breit

Material:

Größen/Sizes:

**Web belt metal buckle**

3 cm wide

80 % Baumwolle/Cotton, 20 % Polyester  
bis 130 cm verstellbar/adjustable until 130 cm

22553A  
schwarz/black

22553B  
oliv/OD green

22553F  
khaki

22553G  
blau/blue

22553L  
weiß/white

22553T  
woodland

22553U  
urban

22553V  
fleckarn/  
BW camo

22553Y  
tropentarn/  
tropical camo





22555J

**Gürtel**

pink, mit Metallschloß, 3,2 cm breit

Material: 100 % Baumwolle/Cotton

Größen/Sizes: bis 80 cm verstellbar/adjustable until 80 cm

**Web belt**

pink, silver buckle, 3,2 cm wide



22573A  
schwarz/black



22573B  
oliv/OD green



22573F  
khaki



**Gürtel, mit Metallkastenschloß**

4,5 cm breit

Material: 80 % Baumwolle/Cotton, 20 % Polyester

Größen/Sizes: bis 130 cm verstellbar/adjustable until 130 cm

**Web belt metal buckle**

4,5 cm wide



22911

**Nackenband-Schlüsselanhänger**

schwarz, 1,9 cm breit, Länge: 57 cm

**Neck strap key ring**

black, width: 1,9 cm, length: 57 cm



**Gürtel**

mit Metallklappschloß, matt silber, 3,2 cm breit

Material: 100 % Polyester

Größen/Sizes: bis 130 cm verstellbar/adjustable until 130 cm

**Web belt**

with silver metal buckle, 3,2 cm wide

22583A  
schwarz/black

22583B  
oliv/OD green



22550

**Gürtel, „Totenkopf“**

schwarz, mit Metallschloß, 3 cm breit

Material: 80 % Baumwolle/Cotton, 20 % Polyester

Größen/Sizes: bis 130 cm verstellbar/adjustable until 130 cm

**Web belt, „skull“**

black, metal buckle, 3 cm wide



-VINTAGE-

**Gürtel, Pure Trash**

mit Metallkastenschloß, 3,8 cm breit

Material: 80 % Baumwolle/Cotton  
20 % PolyesterGrößen/Sizes: bis 110 cm verstellbar/  
adjustable until 110 cm**Web belt, Pure Trash**

with metal buckle, 3,8 cm wide

22591A  
schwarz/  
black22591B  
oliv/  
OD green22591P  
oliv-vintage/  
OD green-  
vintage22591S  
woodland-  
vintage22591T  
woodland22593A  
schwarz/  
black22593B  
oliv/  
OD green22593P  
oliv-vintage/  
OD green-  
vintage22593S  
woodland-  
vintage22593T  
woodland

-VINTAGE-

**Gürtel, Pure Trash**

mit Metallkastenschloß, 3,8 cm breit

Material: 80 % Baumwolle/Cotton  
20 % PolyesterGrößen/Sizes: bis 110 cm verstellbar/  
adjustable until 110 cm**Web belt, Pure Trash**

with metal buckle, 3,8 cm wide

**-VINTAGE-**

**Gürtel, Pure Trash**

mit Metallkastenschloß, 3,8 cm breit  
 Material: 80 % Baumwolle/Cotton  
 20 % Polyester  
 Größen/Sizes: bis 110 cm verstellbar/  
 adjustable untill 110 cm

**Web belt, Pure Trash**  
 with mutable buckle, 3,8 cm wide



mit wendbarem  
 Metallschloß!

22595A  
 schwarz/  
 black



22595B  
 oliv/  
 OD green



22595P  
 oliv-vintage/  
 OD green-  
 vintage

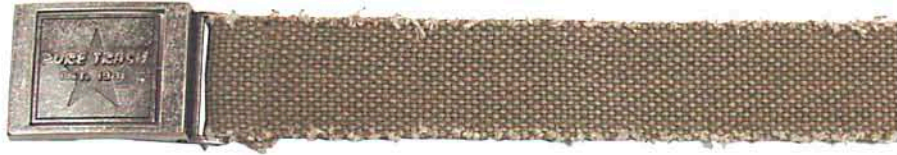

22595S  
 woodland-  
 vintage

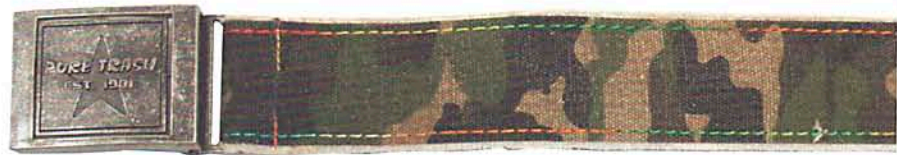

22595T  
 woodland



MILITARY VINTAGE

**[NOT FOR ORDINARY PERSON]**





**22603**  
**Koppel, „Security“**  
 Nylon, schwarz, mit Kunststoff-Sicherheitsverschluss  
**Nylon belt, „Security“**  
 black, with plastic buckle



**22613**  
**Innen-Koppel, „Security“**  
 Nylon, schwarz, mit Klettverschluss  
**Inner belt, „Security“**  
 nylon, black, with velcro



**22653**  
**Handschellen-Etui**  
 Nylon, schwarz,  
 passend zu Koppel 22603  
**Handcuff case**  
 nylon, black, for belt 22603



**22703**  
**Magazintasche**  
 doppelt, Nylon, schwarz,  
 passend zu Koppel 22603  
**Magazine pouch**  
 dual, nylon, black,  
 for belt 22603



**22663**  
**Schlagstockhalter**  
 Nylon, mit Gummiband, schwarz,  
 passend zu Koppel 22603  
**Baton holder**  
 nylon, with elastic band, black,  
 for belt 22603



**22673**  
**Schlüsselanhänger**  
 Nylon, Metallhaken, schwarz,  
 passend zu Koppel 22603  
**Key chain**  
 nylon, metal hook, black,  
 for belt 22603



**22683**  
**Schlüsselanhänger PD**  
 Nylon, PVC-Haken, schwarz,  
 passend zu Koppel 22603  
**Key chain**  
 nylon, PVC-hook, black,  
 for belt 22603

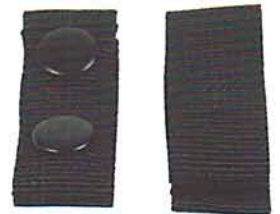

**22623**  
**Gürtelhalter**  
 Nylon, 4 Stk., schwarz  
 mit 2 Druckknöpfen  
**Belt holder**  
 nylon, 4 pcs, black,  
 with 2 buttons

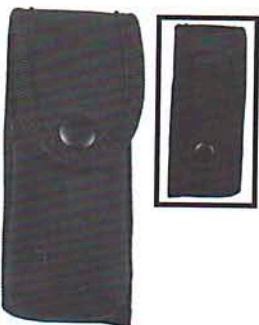

**22733**  
**Verteidigungsspray-Etui**  
 Nylon, schwarz  
 passend zu Koppel 22603  
**Defence spray case**  
 nylon, black, for belt 22603



**22693**  
**Ausweistasche**  
 Nylon, schwarz  
 passend zu Koppel 22603  
**Glove pouch**  
 nylon, black, for belt 22603



**22723**  
**Taschenlampenholster**  
 Nylon, schwarz  
 passend zu Koppel 22603  
 Größe/Sizes: 23 x 5,5 x 3,5 cm  
**Flashlight pouch**  
 nylon, black, for belt 22603



22763A

**Koppel, „Security“**

12-teilig, EVA-Form, Pistolenholster, 4 St. Gürtelhalter, Schlagstock-Taschenlampentasche, Schlüsselhalter, Verteidigungsspray-Tasche klein und groß, Handschellenhalter, Funkgerätehalter, (Pistole nur als Deko!)

Material: 100 % Nylon 1000D

**Nylon belt, „Security“**

12 pcs, EVA-form, 4 pcs belt keeper, D-cell ring holder, key pouch, spray pouch smal and large, handcuff pouch, pistol holster, radio holder



22773A

**Koppel, „Security“**

12-teilig, PP-Einlage, Pistolenholster, 2 St. Gürtelhalter, Handytasche, Schlagstockhalter, Taschenlampen Tasche, Schlüsselhalter, Verteidigungsspray-Tasche, Handschellenetui, Funkgerätehalter, Magazintasche doppelt

Material: 100 % Nylon 1000D

**Nylon belt, „Security“**

12 pcs, plastic form, 2 pcs belt keeper, mobil telefon pouch, key holder, spray pouch, handcuff pouch, buton holder, pistol holster, magazine pouch, radio holder



22783A

**Koppel, „Security“**

8-teilig, PP-Einlage, Pistolenholster, Handschellenetui, Sicherheitsband für Pistole, Taschenlampenetui, Verteidigungsspray-Tasche, 2 Gürtelhalter (Pistole nur als Deko!)

Material: 100 % Nylon 1000D

**Nylon belt, „Security“**

8 pcs, plastic form, spray pouch, handcuff pouch, pistol holster, flashlight pouch, Security spiral wire for gun







**24073A**  
schwarz/black

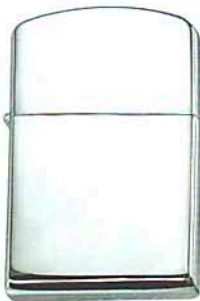

**24073Q**  
chrom poliert/  
chrome polished

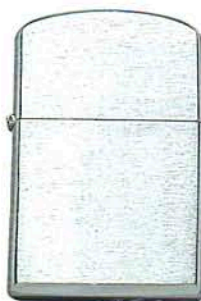

**24073R**  
chrom gebürstet/  
chrome brushed



**24073T**  
woodland

**Benzin-Sturmfeuerzeug**  
Größe/Size: 5,5 x 4 x 1,3 cm  
**Windproof lighter**



**24083Q**  
**Benzin-Sturmfeuerzeug**  
Deutschland, chrom poliert  
Größe/Size: 5,5 x 4 x 1,3 cm  
**Windproof lighter**  
Deutschland, chrome polished



**24190**  
**Outdoor-Feuerzeug**  
Gas, Kunststoffgehäuse,  
mit Sicherungsbügel und Trageriemen  
Größe/Size: 6 x 4 cm  
**Outdoor-lighter**  
fluid, plastic body, with security frame  
and carrying strap

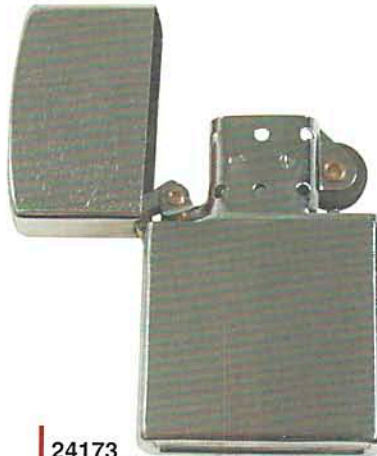

**24173**  
**Benzin-Sturmfeuerzeug, groß**  
silber matt  
Größe/Size: 8,5 x 5,5 x 2 cm  
**Windproof lighter, big**  
chrome brushed

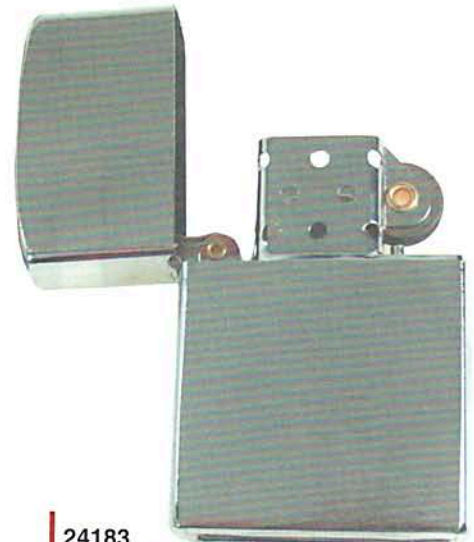

**24183**  
**Benzin-Sturmfeuerzeug, extra groß**  
silber matt  
Größe/Size: 11 x 7 x 2,5 cm  
**Windproof lighter, extra big**  
chrome brushed



**24212**  
**Zippo-Benzin**  
125 ml, für Feuerzeuge  
**Zippo-Lighter**  
fuel 125 ml



**24232**  
**Zippo-Dochte**  
24 St. auf Display  
**Zippo-Wicks**  
24 pcs on display



**24222**  
**Zippo-Feuersteine**  
6 St. im Röllchen,  
24 pro Display  
**Zippo-Flints**  
6 pcs 1 set,  
24 pcs on display



**24713**  
Handwärmer für Brennstäbe  
für Kohlebrennstäbe  
**Pocket handwarmer**  
for fuel sticks



**24723**  
Ersatzbrennstäbe für Handwärmer  
12 Stück in Packung  
**Fuel sticks for pocket handwarmer**  
12 pcs/pack



**24703**  
Handwärmer, Benzin  
im oliven Samtsäckchen  
**Pocket handwarmer for fluid**  
in olive velvet bag

**24733**  
Ersatz-Glühstrumpf für Handwärmer  
für Art. Nr. 24703  
**Glow-part for pocket handwarmer**  
for item no. 24703



**24683B**  
oliv/OD green



**24683T**  
woodland

**Handwärmer, Benzin**  
klein, im schwarzem Samtsäckchen  
**Pocket handwarmer, for fluid**  
small, in black velvet bag



**24763**  
**Gelkissen-Wärmer**  
reaktivierbar, transparent  
**Hot pack**  
reactivable, transparent



**24783**  
**Handwärmer-Kissen**  
für Einmalgebrauch, ca. 6 Std. Wärmedauer  
Größe/Size: 10,5 x 7 cm  
**Mini handwarmer**  
disposable use, up to 6 hours



**24803**  
**Eispack**  
100 g, für Einmalgebrauch  
**Instant ice pack**  
disposable use



**25103**  
**Sportbrille**  
 anthrazit, offener Kunststoffrahmen, mit Etui  
**Sunglasses**  
 anthracite, plastic, open, with box



**25113**  
**Sportbrille**  
 schwarz, offener Kunststoffrahmen, mit Etui  
**Sunglasses**  
 black, plastic, open, with box



**25123**  
**Sportbrille**  
 silber, geschlossener Metallrahmen, mit Etui  
**Sunglasses**  
 silver, metal, closed, with box



**25143**  
**Sportbrille**  
 schwarz, offener Metallrahmen, mit Etui  
**Sunglasses**  
 black, metal, open, with box



Brillen-Box/Etui

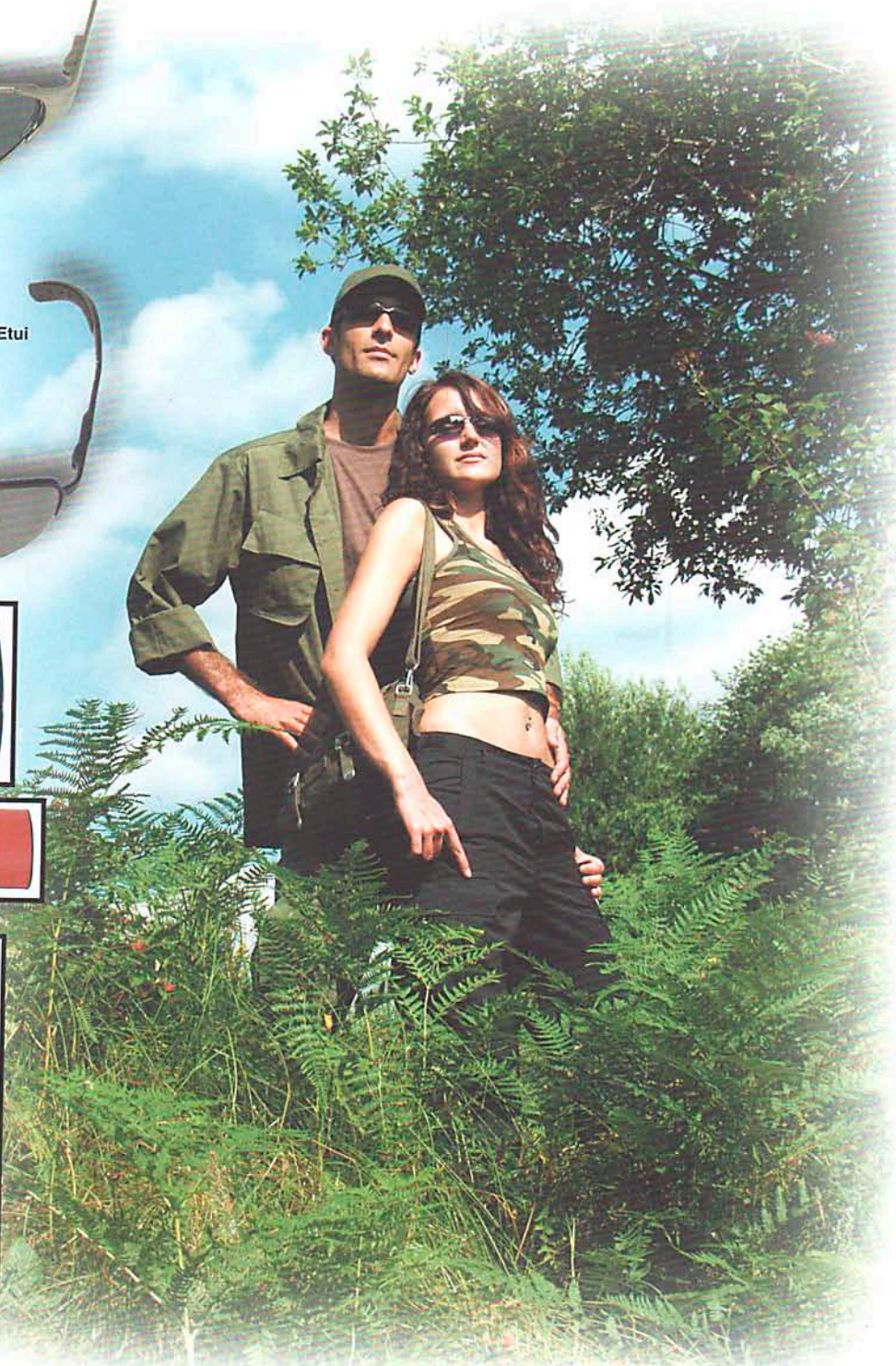
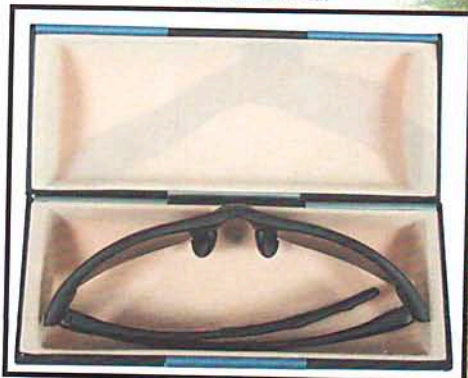



25483  
Brille, „Cabrio“  
chrom  
Sunglasses, „Cabrio“  
chrome



25493  
Brille, „Cabrio“  
schwarz  
Sunglasses, „Cabrio“  
black



25503  
Fliegerbrille, Air Force  
chrom  
Aviator goggles  
chrome



25513  
Fliegerbrille, Air Force  
schwarz  
Aviator goggles  
black



25520  
Bikerbrille, „Eagle1“  
schwarz  
Biker goggles, „Eagle 1“  
black

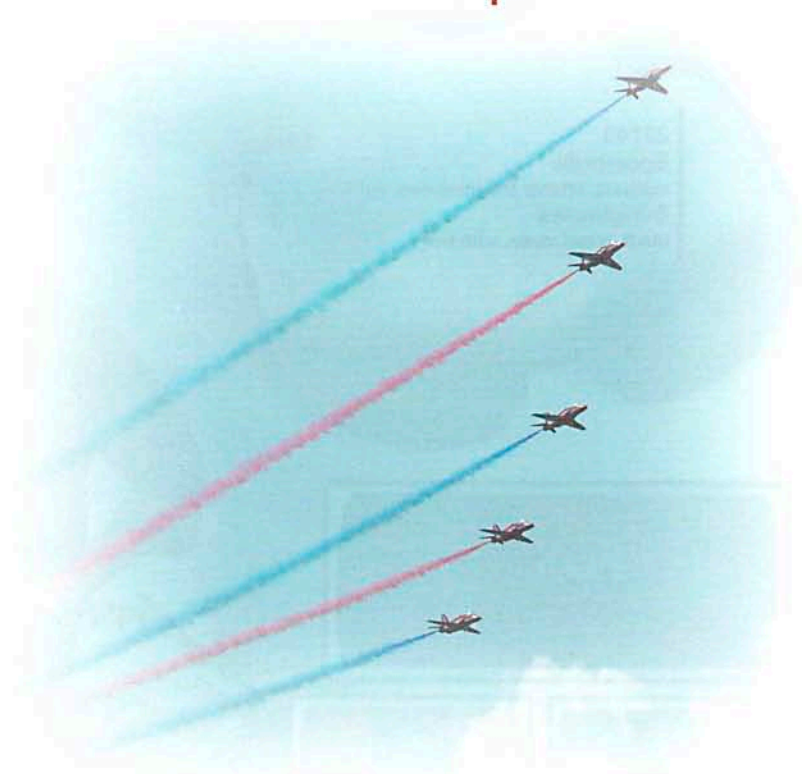

25525  
Bikerbrille, „Eagle2“  
schwarz  
Biker goggles, „Eagle 2“  
black



25533  
Brille, „Mountain“  
gelbe Gläser  
Sunglasses, „Mountain“  
yellow lens



25543  
Bikerbrille, „Highway“  
schwarz, mit Gelenk  
Biker goggles, „Highway“  
black, with joint



25553  
**Bikerbrille, „Run“**  
 schwarz  
**Biker goggles, „Run“**  
 black



25603  
**Schneebrille, „Arber“**  
 schwarz  
**Ski goggles, „Arber“**  
 black



25573A  
 schwarz/black



25573B  
 oliv/OD green



**US Staubschutzbrille, M44**  
 mit Stoffhülle, Kartonbox, Ersatzglas  
 Rauch  
**US dust goggles, M44**  
 cloth bag, cardbord box, spare part  
 glass smoke



25843  
**Schutzbrille, „Thunder“**  
 schwarz, 2 Ersatzgläser, Kartonbox,  
 Standard CE EN 166,  
 Schusstest: 6 mm Stahlkugel bei 120 m per Sek.  
**Safety goggles, „Thunder“**  
 black, 2 spare glasses, cardbord box,  
 standard CE EN 166,  
 shooting test: 6 mm steel balls 120m/sec.



25853A  
 schwarz/black



25853F  
 beige/khaki



**Schutzbrille, „Thunder deluxe“**  
 2 Ersatzgläser, Stoffhülle, Kartonbox,  
 Standard CE EN 166 (B),  
 Schusstest: 6 mm Stahlkugel bei 120 m per Sek.  
**Safety goggles, „Thunder deluxe“**  
 2 spare glasses, cloth bag, cardbord box,  
 standard CE EN 166 (B),  
 shooting test: 6 mm steel balls 120m/sec.

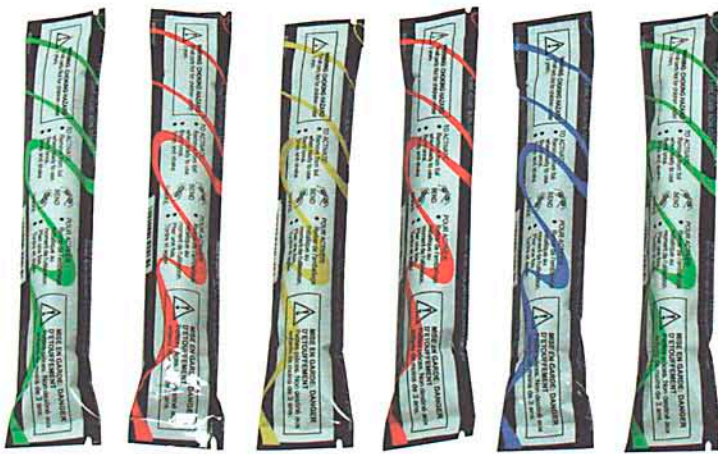

26014L weiß/white  
26014K orange  
26014Q gelb/yellow  
26014I rot/red  
26014G blau/blue  
26014H grün/green



**Leuchtstab**  
8-12 Std. Leuchtdauer  
Größe/Size: 15 x 1,5 cm  
**Light-stick**  
8-12 hours



26065  
**Leuchtstab**  
Mini, (Fischer-Knicklicht)  
grün, 2-er Pack  
Größe/Size: 3 x 23 mm  
**Light-stick**  
mini, fisher bend light,  
green, 2 pcs

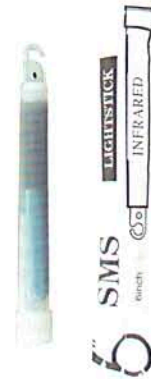

26024  
**Leuchtstab, Infrarot**  
nur mit Nachtsichtgerät sichtbar  
Größe/Size: 15 x 1,5 cm  
**Infrared light stick**  
only visual with night vision device

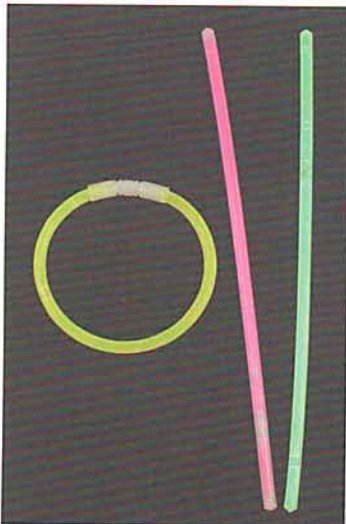

26054  
**Leuchtstab**  
als Halsband und Armreif verwendbar,  
diverse Farben, 65 Stück/Rolle  
Größe/Size: 5 x 200 mm  
**Light-stick**  
useable as necklace and bangle,  
div. colour, 65 psc/roll



26044  
**Leuchtstab**  
Mini, (Fischer-Knicklicht) 10 Stk. in Display,  
5 verschiedene Farben  
Größe/Size: 50 x 6 mm  
**Light-stick**  
mini, fisher bend light, 10 pcs in display,  
5 different colours



26753  
**Wiederaufladbare Batterie, groß**  
Mono, 1,5 Volt, 2-er Pack  
**Battery, rechargeable**  
mono, 1,5 volt, 2 pcs



26295A  
**Ersatzbirnen, 2,4 V**  
2 Stück  
**Spare bulbs, 2,4 V**  
2 pcs

26295B  
**Ersatzbirnen, 4,8 V**  
2 Stück, für Blocktaschenlampe  
(Art.-Nr. 26373)  
**Spare bulbs, 4,8 V**  
2 pcs, fits for item no. 26373



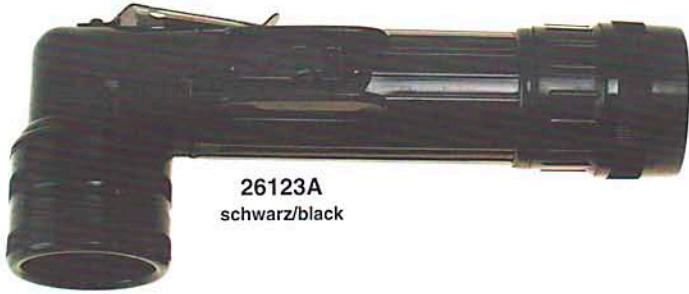

26123A  
schwarz/black



26123B  
oliv/OD green



26133V  
flecktarn/BW camo



26133T  
woodland



**US Winkeltaschenlampe, groß**

mit Schutzbacken, Halteclip für Gürtel, Koppel, Rucksack usw., verschiedene Farbfilter und 1 Ersatzbirne im Bodenteil, benötigte Batterien: 2 Stk. D-Size, Gesamtlänge: 205 mm

**Military anglehead flashlight, large**

with protection units, retaining clip for belt, backpack and so on, different colour filters and 1 spare bulb in the bottom, required batteries: 2 pieces D-size, length: 205 mm



26163B  
oliv/OD green



26163A  
schwarz/black



26173T  
woodland



26173Y  
BW tropentarn/  
BW tropical camo

**US Winkeltaschenlampe, mittel**

mit Schutzbacken, Halteclip für Gürtel, Koppel, Rucksack usw., verschiedene Farbfilter und 1 Ersatzbirne im Bodenteil, benötigte Batterien: 2 Stk. C-Size, Gesamtlänge: 170 mm

**Military anglehead flashlight, medium**

with protection units, retaining clip for belt, backpack and so on, different colour filters and 1 spare bulb in the bottom, required batteries: 2 pieces C-size, length: 170 mm



26213T  
woodland



26203A  
schwarz/black



26203B  
oliv/OD green



26213V  
flecktarn/BW camo

**US Winkeltaschenlampe, klein**

mit Schutzbacken, Halteclip für Gürtel, Koppel, Rucksack usw., verschiedene Farbfilter und 1 Ersatzbirne im Bodenteil, benötigte Batterien: 2 Stk. AA-Size, Gesamtlänge: 160 mm

**Military anglehead flashlight, small**

with protection units, retaining clip for belt, backpack and so on, different colour filters and 1 spare bulb in the bottom, required batteries: 2 pieces AA-size, length: 160 mm



26603

**Taschenlampenhalter**

mit Ring und Nylonclip, schwarz  
**Flashlight pouch**  
w/loop and nylon clip, black

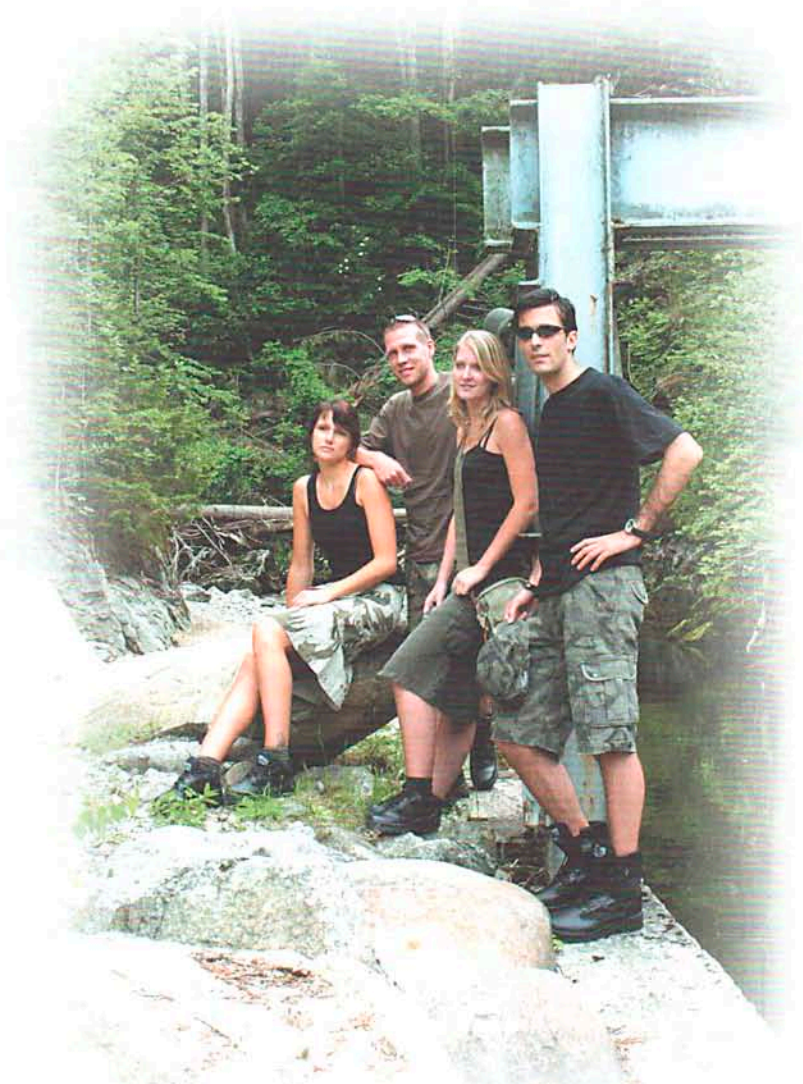



**Super Bright**

**26405**

**Stirnlampe, 4 LED weiß, 3 LED rot**  
klappbar, schwarz, verstellbares Gummiband, beweglicher Leuchtkopf, wasserdicht, 3 Funktionen (Betrieb mit 2 bzw. 4 LED weiß oder 3 LED rot), 3 AAA Batterien (nicht enthalten!)  
Gewicht: 80 Gramm (ohne Batterie u. Verpackung)

**Headlamp, 4 LED white, 3 red**  
foldable, black, adjustable elastic band, flexible lightspot, waterproof, 3 functions (operation with 2/4 white LEDs or 3 red LEDs), 3 AAA batteries required, weight: 80 g



**26423**

**Stirnlampe, Crypton**  
schwarz, wasserdicht, klappbar, größenverstellbares Stirnband mit Mittelriemen, Gummipolsterung, 90° schwenkbar, 2.4 V/0.25 Crypton-Birne, mit Ersatzbirne, 2 AA-Size Batterien (nicht enthalten!)  
Gewicht: 90 Gramm (ohne Batterie u. Verpackung)

**Headlamp, crypton**  
black, waterproof, foldable, adjustable headband in width with middle strap, rubber padding, 90° pivotable, 2.4V/0.25A crypton-bulb, with spare bulb, 2 AA-size batteries (not included), weight: 90 g

**STRONG LIGHT AND LONG LASTING**



**26430**

**Stirnlampe, 8 LED**  
wasserdicht, klappbar, schwarz, 90° schwenkbar, Drehschalter, verstellbares Gummiband, mit Mittelriemen, Gummipolsterung, 8 LED-Lampen, 4.8 V/0,5 Crypton Birne, 4 AA Batterien (nicht enthalten!)  
Gewicht: 130 Gramm (ohne Batterie u. Verpackung)

**Headlamp, 8 LED**  
black, waterproof, foldable, 90° pivotable, turn switch, adjustable elastic band, with middle strap, rubber padding, 4,8V/0,5 crypton-bulb, 4 AA-size batteries required (not included), weight: 130 g

**Super Bright**



**26433**

**Stirnlampe, 3 LED, 1 Crypton**  
wasserdicht, klappbar, schwarz, 90° schwenkbar, Knopfschalter, verstellbares Gummiband, mit Mittelriemen, Gummipolsterung, 2 Funktionen, 3-LED-Lampen oder 3.6 V/0.25 Crypton Birne, 3 AAA Batterien (nicht enthalten!)  
Gewicht: 95 Gramm (ohne Batterie u. Verpackung)

**Headlamp, 3 LED, 1 crypton**  
black, waterproof, foldable, 90° pivotable, buttonswitch, adjustable elastic band, with middle strap, rubber padding, 2 functions, 3-LED-Lamps or 3.6V/0.25A crypton bulb, 3 AAA-size batteries required (not included), weight: 95 g





26437

**Stirnlampe, 3 LED, 1 Crypton**

schwarz, klappbar, verstellbares Gummiband, mit Mittelriemen, Gummipolsterung, 3 Schalt-Funktionen, 1 Birne 0,25 W., 5 mm weiße LED's, super Leuchtkraft, lange LED Lebensdauer, super klein und leicht, wasserdicht, schwenkbar, hoher Tragekomfort, 3 AAA Batterie (nicht enthalten!)  
Gewicht: 100 Gramm (ohne Batterie u. Verpackung)

**Headlamp, 3 LED, 1 crypton**

black, adjustable elastic band, with middle strap, rubber padding, 3 control functions, 5 mm white LEDs, super luminosity, long LED life endurance, very small and light, waterproof, pivotable and high wearing comfort, 3 AAA-size batteries required (not included), weight: 100 g



Super Bright

26435

**Stirnlampe, 4 LED**

klappbar, schmal, schwarz, wasserdicht, verstellbares Gummiband, mit Mittelriemen, Gummipolsterung, Batteriefach hinten, super Leuchtkraft, 2 Funktionen (Betrieb mit 2 oder 4 LED), 3 AAA Batterien hinten (nicht enthalten!)  
Gewicht: 80 Gramm (ohne Batterie u. Verpackung)

**Headlamp, 4 LED**

slim form, black, waterproof, adjustable elastic band, with middle strap, rubber padding, battery compartment at the back, super luminosity, 2 functions (operation with 2/4 LEDs), 3 AAA-size batteries required (not included), weight: 80 g

STRONG LIGHT AND LONG LASTING

Super Bright



26445

**Stirnlampe, 1 Watt Luxeon, ABS Gehäuse**

superhelle 1 W LED, verstellbares Gummiband, mit Mittelriemen, Gummipolsterung, beweglicher Leuchtkopf 180°, Dauer-, oder Blinklicht einstellbar, super klein und leicht, wasserdicht, Leuchtdauer ca. 8 Std., 3 AAA Batterien (nicht enthalten!)  
Gewicht: 100 Gramm (ohne Batterie u. Verpackung)

**Headlamp, 1 Watt luxeon, ABS body**

superbright 1 W LED, adjustable elastic band, with middle strap, rubber padding, pivotable lightspot around 180°, continuous light or flashing light selectable, small and light, waterproof, light endurance about 8h, 3 AAA-size batteries required (not included), weight: 100 g

26447

**Stirnlampe, 1 Watt Luxeon, 1 LED weiß, 2 LED rot**

verstellbares Gummiband mit Mittelriemen, Gummipolsterung, wasserdicht, beweglicher Leuchtkopf 180°, 4 Funktionen (Betrieb mit 1 Watt LED bzw. 1 LED weiß oder 2 LED rot Dauer-, oder Blinklichtbetrieb), Leuchtdauer ca. 8 Std., 3 AAA Batterien (nicht enthalten!)  
Gewicht: 90 Gramm (ohne Batterie u. Verpackung)

**Headlamp, 1 Watt luxeon, 1 LED white, 2 LED red**

adjustable elastic band with middle strap, rubber padding, waterproof, pivotable lightspot 180°, 4 functions, operation with 1 watt LED, 1 LED white or 2 LEDs red, continuous light or flashing light, light endurance about 8h, 3 AAA-size batteries required (not included), weight: 90 g



26324

**LED Leuchte, 3 Watt**

Alu-Gehäuse, wiederaufladbar, superhelle 3 Watt LED Leuchte, Dauer- oder Blicklichtfunktion, Leuchtkopf im Kronendesign, Trageschleife, incl. Ladegerät für 12V und 220V, in Geschenkbox  
Länge: 15 cm

**LED flashlight, 3 watts**

rechargeable, bright 3 watts LED flashlight in box, continuous light or flashing light, lamp head in crowns-design, carry loop, incl. recharger for 12V and 220V, length: 15 cm

**Super Bright**

26333

**LED Leuchte, Pocket**

silbernes Alugehäuse, super Leuchtkraft, 1 Watt Luxeon LED, Leuchtdauer ca. 6 Std., mit Trageschleife und Nylon-Tasche, 3 AAA Batterien (nicht enthalten!)

**LED flashlight**

aluminium body, silver, super luminosity, 1 watt luxeon LED, light endurance about 6 hrs, with carrying clew and nylon bag, 3 batteries AAA (not included)



26353

**LED Leuchte, Alugehäuse**

3 LED super hell, 3-5 mm weiße LED's, super Leuchtkraft, lange LED-Lebensdauer, wasserdichtes ALU-Gehäuse, Druckknopf-Schalter, Tragegurt, 3 AAA Batterien (nicht enthalten!)

**LED flashlight, aluminium body**

3 LED super bright, 3-5 mm white LED's, super luminosity, long LED durability, waterproof ALU-shell, pushbutton-switch, carrying strap, 3 AAA-size batteries required (not included)



26493

**Stablampe, 5 Watt LED**

schwarz, wiederaufladbar, leistungsstarke Handtaschenlampe, incl. Ladegerät für 220V, Länge: 20 cm

**Flashlight, 5 Watt LED**

black, rechargeable, efficient flashlight, recharger for 220V included, length: 20 cm



26449

**Cap-Light, mit 5 LED**

incl. 2 Ersatz Knopfzellen

**Cap light, with 5 LED**

with 2 extra batteries



26355J

**LED Leuchte, Alugehäuse**

Typ 95 CZ tarn, 9 weiße LED's, super Leuchtkraft, lange LED-Lebensdauer, wasserdichtes ALU-Gehäuse, Druckknopf-Schalter, Tragegurt, Länge: 9,5 cm, 3 AAA Batterie (nicht enthalten)

**LED flashlight, aluminium body**

Typ 95 CZ camo, 9 white LED's, super luminous power, long LED-working life, waterproof ALU-body, press button-switch, carrying strap, length: 9,5 cm, 3 AAA battery (not included)





26393

**Handstrahler, wiederaufladbar**

gelb, drehbarer Griff, 1 MCP, praktische Stehvorrichtung, wasserdicht, hohe Leuchtkraft (1.000.000 cl), incl. Ladegerät für 12V und 220V, Länge: 21 cm, Durchmesser: 13 cm

**Spotlight, rechargeable**

yellow, pivotable handle, 1 MCP, handy standing device, waterproof, high glowing power (1.000.000 cl), turnable handle, incl. charger for 12V and 220V, length: 21 cm, diameter: 13 cm



26373

**US Blocktaschenlampe**

oliv, wasserdicht, großer Reflektor, Durchmesser: 10 cm, Länge: 20 cm, incl. Adapter für 4 Mono Batterien (1,5 Volt, R 20, nicht enthalten!), praktische Handschlaufe

**US lamp**

OD green, waterproof, large reflector, diameter: 10 cm, length: 20 cm, incl. adapter for 4 mono batteries, effectively carrying clew



26473

**Camping-Laterne**

17 LED, wasserdicht, silber-schwarz, 2 Schalt-Funktionen (Betrieb mit 7 oder 17 LED weiß), mit Karabinerhaken, 4 AA-Size Batterien (nicht enthalten!) Höhe: 15 cm, Gewicht: 230 g

**Camping lantern**

17 LED, waterproof, silver-black, 2 control functions (operation with 7/17 white LEDs), snap hook, 4 AA batteries required, height: 15 cm, weight: 230 g

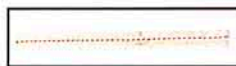

26853

**Docht**

für Sturmlaterne, passend für Art.-Nr. 26803

**Wick**

for kerosene-lamp, for item no. 26803



26803

**Sturmlaterne**

Zink, für Petroleum, mit Tragehenkel, Höhe: 30 cm

**Kerosene-Lamp**

zinc, for petroleum, with carrying handle, height: 30 cm



26389

**Stativ-LED Taschenlampe**

schwarz, 3 LED, 90° schwenkbar, Knopfschalter, 3 Schalt-Funktionen (Betrieb mit 1, 2 oder 3 LED weiß), 3 AAA Batterien (nicht enthalten!), Höhe: 15 cm

**LED flashlight with tripod**

black, 3 LED, 90° pivoted, button switch, 3 switch functions (operation with 1, 2 or 3 LED white), 3 AAA batteries required, height: 15 cm



26943

**Keramik für Petroleum-Laterne**

(Art.-Nr. 26903)

**Ceramic for kerosene lamp**

(item no. 26903)



26953

**Ersatzteilesset für Petroleum-Laterne**

(Art.-Nr. 26903)

**Spare part set for kerosene lamp**

(item no. 26903)

**26870****Fackeln**

3-er Pack, 40 cm lang,  
Brenndauer: ca. 30 Minuten

**Torches**

3 pcs/pack, 40 cm long,  
burning time: about 30 min

**26873****Fackeln**

3-er Pack, 55 cm lang,  
Brenndauer: ca. 40 Minuten

**Torches**

3 pcs/pack, 55 cm long,  
burning time: about 40 min



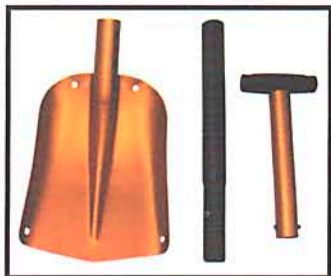

27013

**Lawinenschaufel**

Aluminium, ausziehbarer Stiel von 66 auf 80 cm, zerlegbar, Schaufelgröße: 280 x 215 x 1,7 mm

**Snow shovel**

aluminium, extendable handle from 66 to 80 cm, demountable, dimensions of the shovel: 280 x 215 x 1,7 mm



27011

**Lawinenschaufel „Deluxe“**

Aluminium, mit Tasche, 3-teilig, zerlegbar, Transportbeutel, ausziehbarer Stiel von 65 auf 80 cm, Schaufelgröße: 280 x 215 x 1,7 mm

**Snow shovel „Deluxe“**

aluminium, with bag, 3 pieces, extendable handle from 65 to 80cm transport bag, demountable, shovel size: 280 x 215 x 1,7 mm



27031

**Klappspaten**

Plastikgriff, schwarz, mit Tasche

**Folding shovel**

plastic handle, black, with bag

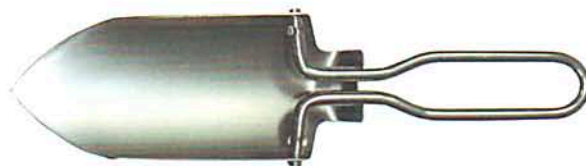

27035

**Mini-Schaufel**

klappbar, mit Tasche, Länge offen: 22,5 cm, Schaufelgröße: 12 x 5,5 cm

**Mini shovel**

foldable, with bag, length open: 22,5 cm, shovel size: 12 x 5,5 cm



27037

**Multifunktionsset**

„6 in 1“, besteht aus: Universalstiel, Beil, Spaten, Säge, Messer mit Flaschenöffner, Transporttasche

**Multifunction-set**

„6 in 1“, composed by: universal handle, hatchet, spade, saw, knife with bottle opener, transport bag



**27033**  
**Klappspaten, BW Modell**  
 3-teilig, Alu, mit gebrauchter Kunststoff-Tasche  
**BW folding shovel, model**  
 3 parts, alu, with used plastic cover



**27034**  
**Klappspaten, 3-teilig, Mini**  
 mit Nylontasche  
**BW folding shovel, mini**  
 with cover

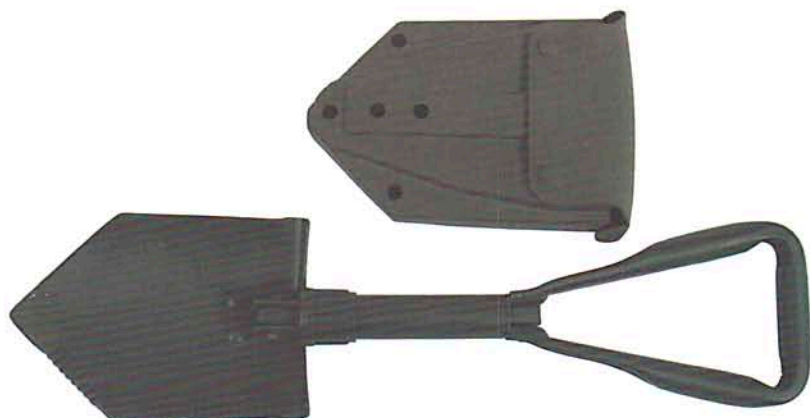

**27043**  
**US Klappspaten**  
 3-teilig, extra stabil,  
 mit Kunststoff-Tasche  
**US folding shovel**  
 3 parts, extra solid,  
 with plastic cover

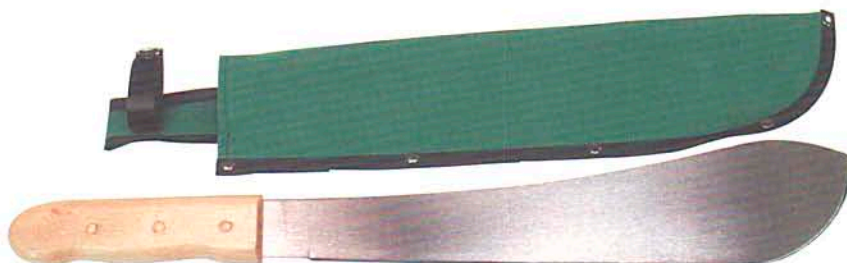

**27063**  
**Bolo Machete**  
 mit Canvas-Scheide, Holzgriff  
 Länge: 50,5 cm, Klinge: 35,5 cm  
**Bolo machete**  
 with canvas sheath, wooden handle  
 length: 50,5 cm, blade: 35,5 cm

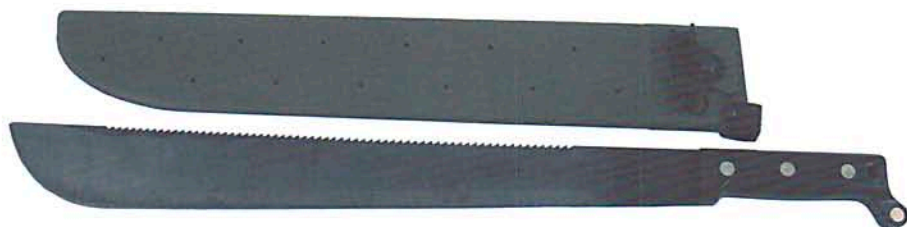

**27073**  
**Bolo Machete**  
 mit Sägerücken und Plastikhülle, wie original US  
 Länge: 59 cm, Klinge: 45,5 cm  
**Bolo machete**  
 with sawtooth and plastic cover, as original US  
 length: 59 cm, blade: 45,5 cm

**27080**  
**Klappsäge**  
 oliv, Blattlänge: ca. 15 cm,  
 Länge: offen 36 cm, geschlossen 20,5 cm  
**Folding saw**  
 OD green, sheet length: ca. 15 cm,  
 length: open 36 cm, closed 20,5 cm



**27082**  
**Klappsäge, „Deluxe“**  
 schwarz, Blattlänge: ca. 19 cm,  
 Länge: offen 41 cm, geschlossen 22 cm  
**Folding saw, „Deluxe“**  
 black, sheet length: ca. 19 cm,  
 length: open 41 cm, closed 22 cm





**27088**  
**Ketten-Hand-Säge**  
 mit Griffen, 65 Zähne, Länge: 73 cm  
**Chain saw**  
 extra strong, 65 pcs teeth, length: 73 cm



**27085**  
**Draht-Säge**  
 mit Ringen,  
 extra stabile Ausführung  
**Wire saw**  
 extra strong

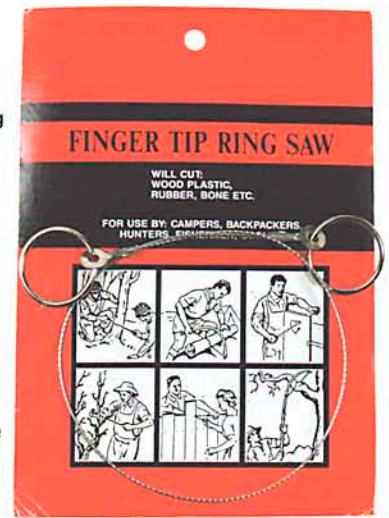

**27083**  
**Draht-Säge**  
 mit Ringen  
**Wire saw**



**27103**  
**Feuerstarter**  
 Army, Mod.  
**Fire starter**  
 Army, Mod.



**27105**  
**Feuerstarter, Set**  
 1 Magnesium-Stab mit Schaber, Watte,  
 2 Brennstofftabletten, 1 Metallbox  
 Größe/Size: 10,2 x 8,3 x 2 cm  
**Fire starter, set**  
 1 magnesium pole with scraper, cotton  
 wool, 2 fuel tablets, 1 metalbox



**27106**  
**Feuerstarter, Automatik**  
**Fireball flint, Automatic**



**27108**  
**Schwedischer Feuerstarter**  
 Army  
**Swedish fire starter**  
 Army



**27101**  
**Magnesiumstarter, „Army“**  
**Magnesium fire starter, „Army“**



**27127**  
**Wasseraufbereiter**  
 Mini, oliv,  
 reinigt Wasser von Krankheitserregern, Kolibakterien,  
 Schädlingsbekämpfungsmittel, schweren Metallen,  
 Chlor und anderen Unreinheiten, verbessert den Geschmack,  
 Produktion: ca. 0,3 l/min, Kapazität: 2000 Liter,  
 Gewicht: ca. 90 g, Größe: 13,8 x 5,7 x 2,8 cm,  
 Material: Plastik, Keramik, NMC  
**Water microfilter**  
 mini, OD green,  
 removes microscopic pathogens, pesticides, heavy metals,  
 chlorine and other impurities from water, improve taste,  
 Output: ca. 0,3 l/min, Capacity: 2000 Liter, Weight: ca. 90 g,  
 Size: 13,8 x 5,7 x 2,8 cm, Material: Plastic, Ceramic, NMC





**27113**  
**Notfallset, 5 in 1**  
 wasserdichte Box, mit Umhängeband,  
 Kompass, Pfeife, Spiegel, Feuerstein  
 Länge: 11,5 cm  
**Survival kit, 5 in 1**  
 waterproof box, with lanyard,  
 compass, whistle, mirrow, firestone  
 length: 11,5 cm



**27123**  
**Streichholzbox**  
 oliv, wasserdicht,  
 mit Streichhölzer, Spiegel, Angelhaken  
 Länge: 7,5 cm  
**Match box**  
 waterproof, OD green,  
 with matches, mirrow, fishinghook  
 length: 7,5 cm



**27093**  
**Flaschenöffner, Alu**  
 als Schlüsselanhänger  
**Bottle opener, alu**  
 as key chain



**27115**  
**Combat Überlebensset**  
 wasserdichte Box, Größe: 12 x 10 x 3,5 cm  
 Inhalt:  
 Messer, Pfeife, Draht-Säge, Draht, Angel-Set, Watte,  
 Streichhölzer, Kerze, Bleistift, Mini-Kompass, Nähset,  
 Sicherheitsnadeln, Feuerstarter, 2 Spiegel,  
 Überlebensanleitung  
**Combat Survival kit**  
 waterproof box, Size: 12 x 10 x 3,5 cm  
 contents:  
 with knife, whistle, wire-saw, wire, fishing-set,  
 cotton wool, matches, candle, pencil, mini-compass,  
 sew-set, safety pin, fire starter, 2 mirror,  
 survival-instruction



**27117**  
**Überlebensset, klein**  
 wasserdichte Box, Größe: 13,5 x 8 x 4 cm  
 Inhalt:  
 Pfeife, Draht-Säge, Draht, Angel-Set, Watte, Streichhölzer,  
 Kerze, Bleistift, Mini-Kompass, Nähset, Feuerstarter,  
 Schneideklinge, Spiegel, Überlebensanleitung  
**Survival kit, small**  
 waterproof box, Size: 13,5 x 8 x 4 cm  
 contents:  
 pipe, wire-saw, wire, fish-set, cotton wool, matches,  
 candle, pencil, mini-compass, sew kit, fire starter,  
 cutting blade, mirror, survival instruction



**27131**  
**Notfall-Rettungsdecke**  
 silber- und goldfarben beschichtet,  
 leicht und klein faltbar, schützt vor Kälte,  
 als Schlafsackunterlage gut geeignet  
 Größe/Size: 213 x 132 cm  
**Emergency blanket**  
 silver and gold-coated,  
 light and small foldable,  
 protects from the cold,  
 suitable as sleeping bag pad

**27133**  
**Notfall-Rettungsdecke**  
 Alu-beschichtet, leicht und klein faltbar,  
 schützt vor Kälte,  
 als Schlafsackunterlage gut geeignet  
 Größe/Size: 213 x 132 cm  
**Emergency blanket**  
 aluminium-coated,  
 light and small foldable,  
 protects from the cold,  
 suitable as sleeping bag pad







**27143**  
**Box, Aluminium**  
 wasserdicht, silber  
 Größe/Size: 13,3 x 9,2 x 3,4 cm  
**Box, aluminium**  
 waterproof, silver



**27153**  
**Box, Metall**  
 wasserdicht, schwarz, groß  
 Größe/Size: 17 x 11,5 x 5,5 cm  
**Box, metall**  
 waterproof, black, big size



**27161**  
**Box, Kunststoff**  
 wasserdicht, schwarz, verstellbarer Tragegurt,  
 Rasterschaumstoffeinsatz,  
 Rasterung der Würfelkontur: 1,5 x 1,5 cm  
 Größe/Size: 39 x 29 x 12 cm  
**Box, plastic**  
 waterproof, black, with adjustable carrying strap,  
 raser foam compartment,  
 rasterization of the cube shape: 1,5 x 1,5 cm



**27166**  
**Box, Kunststoff**  
 wasserdicht, schwarz  
 Größe/Size: 16,5 x 12 x 7,5 cm  
**Box, plastic**  
 waterproof, black



**27168**  
**Box, Kunststoff**  
 wasserdicht, schwarz  
 Größe/Size: 13,5 x 8 x 3,7 cm  
**Box, plastic**  
 waterproof, black



27233

**Teleskopschlagstock, Carbon**

schwarz, mit Nylonetui  
 Länge: offen 56 cm, geschlossen 23 cm  
**Baton, Carbon**  
 black, with nylon etui  
 length: opened 56 cm, closed 23 cm



27243

**Metallschlagstock**

ausziehbar, schwarz, mit Nylonetui  
 Länge: offen 53,5 cm, geschlossen 20,5 cm  
**Baton**  
 telescope, black, with nylon etui  
 length: opened 53,5 cm, closed 20,5 cm



27245

**Metallschlagstock**

ausziehbar, chrom, mit Nylonetui  
 Länge: offen 53,5 cm, geschlossen 20,5 cm  
**Baton**  
 telescope, chrome, with nylon etui  
 length: opened 53,5 cm, closed 20,5 cm



27244

**Metallschlagstock**

ausziehbar, schwarz, mit Nylonetui, kurz  
 Länge: offen 41 cm, geschlossen 16,5 cm  
**Baton**  
 telescope, black, with nylon etui, short  
 length: opened 41 cm, closed: 16,5 cm



27255

**US Schlagstock**

mit Seitengriff, Kunststoff, Länge: ca. 60 cm  
**US baton**  
 with side handle, plastic, length: about 60 cm

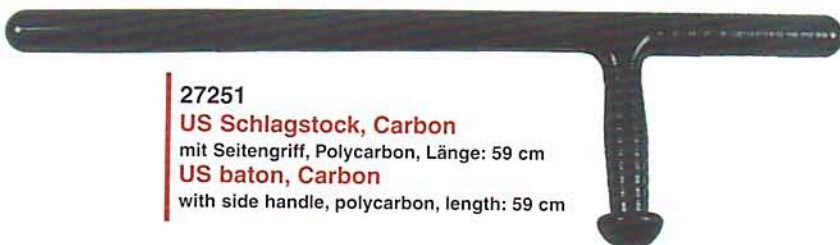

27251

**US Schlagstock, Carbon**

mit Seitengriff, Polycarbon, Länge: 59 cm  
**US baton, Carbon**  
 with side handle, polycarbon, length: 59 cm



27257

**Schlagstockhalter**

mit Lederschleife  
**Baton holder**  
 with leather loop



27256

**Verteidigungs-Knüppel**

mit Schlaufe, Leder  
 Länge: 35 cm  
**Defense stave**  
 with loop, leather  
 length: 35 cm





**27302**  
Pfefferspray  
in Sprühflasche, 40 ml  
Pepper spray  
spray bottle, 40 ml



**27262**  
CS Reizgas  
Sprühflasche, 40 ml  
CS defence spray  
spray bottle, 40 ml



**27305**  
Pfefferspray, Direktstrahl  
in Sprühflasche, 40 ml  
Pepper spray, direct  
spray bottle, 40 ml



**27307**  
Pfefferspray, Direktstrahl  
in Sprühflasche, 63 ml  
Pepper spray, direct  
spray bottle, 63 ml



**27321**  
Zecken-Frey  
in Sprühflasche, 25 ml  
Ticks spray  
bottle, 25 ml



**27383**  
Waffen-Reinigungsset  
mit Kette, Bürsten, Dochte und Pinsel  
Weapon cleaning kit  
with chain, brushes, wicks



**27523**  
Hosengummi  
oliv, mit Metallhaken  
Elastic straps for pants  
OD green, with metal hook



**27354**  
Tarnstift, England  
zweifarbige, grün-braun  
GB camo face paint  
2 colours, green-brown



**27363**  
Tarnschminkset  
3 Farben, mit Spiegel  
Camo face paint  
3 colours, with mirror



**27369**  
Tarnschminkset  
3 Farben, 3 Tuben je 35 g  
Camo face paint  
3 colours, 3 tubas per 35 g



**27173**  
Werkzeugset  
2 Klingen: 6,5 cm (eine mit Wellenschliff),  
Säge, Zange, Seitenschneider, Eisenfeile,  
3 Schlitzschraubendreher, 1 Kreuzschlitzdreher,  
Stechdorn, Flaschen- u. Dosenöffner, mit Nylonbeutel  
Pocket tool  
2 blades: 6,5 cm (one serrated), saw, plier,  
side cutter, iron file, 3 slot screwdrivers,  
stickthorn, bottle- and can opener, with nylon bag



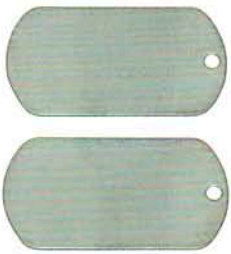

**27404**  
**US Erkennungsmarke**  
 silber, Edelstahl, mit Ketten  
**US dog tag set**  
 silver, stainless steel, with chains

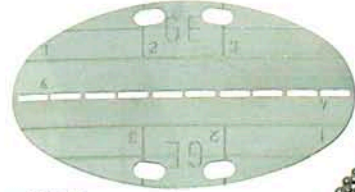

**27411**  
**BW Erkennungsmarke**  
 oval, mit Ketten  
**BW dog tag set**  
 oval, with chains



**27463**  
**US Erkennungsmarke**  
 schwarz, mit Ketten  
**US dog tag set**  
 black, with chains



**27473**  
**US Erkennungsmarke**  
 gold, mit Ketten  
**US dog tag set**  
 gold, with chains



**27434**  
**US Silencer**  
 für US Erkennungsmarken, Gummi  
**US dog tag silencer**  
 for US dog tags, rubber





27503A

**Seil**  
oliv, 5 mm, 15 Meter  
**Rope**  
OD green, 5 mm, 15 meter



27503B

**Seil**  
oliv, 7 mm, 15 Meter  
**Rope**  
OD green, 7 mm, 15 meter



27503C

**Seil**  
oliv, 9 mm, 15 Meter  
**Rope**  
OD green, 9 mm, 15 meter



27501A

**Seil**  
tarn, 5 mm, 15 Meter  
**Rope**  
camo, 5 mm, 15 meter



27501B

**Seil**  
tarn, 7 mm, 15 Meter  
**Rope**  
camo, 7 mm, 15 meter



27501C

**Seil**  
tarn, 9 mm, 15 Meter  
**Rope**  
camo, 9 mm, 15 meter



27505A

**Seil**  
oliv, 5 mm, 60 Meter  
**Rope**  
OD green, 5 mm, 60 meter



27505B

**Seil**  
oliv, 7 mm, 60 Meter  
**Rope**  
OD green, 7 mm, 60 meter



27505C

**Seil**  
oliv, 9 mm, 60 Meter  
**Rope**  
OD green, 9 mm, 60 meter





**27533A**  
**Karabinerhaken**  
 oliv, D 5 mm x 5 cm  
**Carabiner**  
 OD green, D 5 mm x 5 cm



**27533B**  
**Karabinerhaken**  
 oliv, D 6 mm x 6 cm  
**Carabiner**  
 OD green, D 6 mm x 6 cm



**27533C**  
**Karabinerhaken**  
 oliv, D 7 mm x 7 cm  
**Carabiner**  
 OD green, D 7 mm x 7 cm



**27533D**  
**Karabinerhaken**  
 oliv, D 8 mm x 8 cm  
**Carabiner**  
 OD green, D 8 mm x 8 cm



**27543A**  
**Karabinerhaken**  
 tarn, D 5 mm x 5 cm  
**Carabiner**  
 camo, D 5 mm x 5 cm



**27543B**  
**Karabinerhaken**  
 tarn, D 6 mm x 6 cm  
**Carabiner**  
 camo, D 6 mm x 6 cm



**27543C**  
**Karabinerhaken**  
 tarn, D 7 mm x 7 cm  
**Carabiner**  
 camo, D 7 mm x 7 cm



**27543D**  
**Karabinerhaken**  
 tarn, D 8 mm x 8 cm  
**Carabiner**  
 camo, D 8 mm x 8 cm



**27550**  
**Alu-Karabiner, „Crab“**  
 Größe/Size: 5 x 3 cm  
**Alu-carabiner, „Crab“**



**27553**  
**Alu-Karabiner, „Crab“**  
 Größe/Size: 4 x 6 cm  
**Alu-carabiner, „Crab“**



**27555**  
**Alu-Karabiner, „Crab“**  
 Größe/Size: 5,6 x 8,6 cm  
**Alu-carabiner, „Crab“**



**27585**  
**Pfeife**  
 Metall, rund, mit olivem Halsband,  
 Länge: 6,5 cm, Halsbandlänge: 50 cm  
**Whistle**  
 metal, circular, with OD green neck strap,  
 length: 6,5 cm, necklace length: 50 cm



**27564**  
**Pfeife**  
 Alu, Länge: 9 cm  
**Whistle**  
 Alu, length: 9 cm



27685B  
oliv/OD green



27685A  
schwarz/black

27685R  
coyote tan



**Ellenbogenschützer**

Neopren, hoher Tragekomfort, extremer Schutz, mit verstellbaren Verschlüssen

**Elbow pad**

neopren, high wearing comfort, extreme protection, adjustable fasteners



27695B  
oliv/OD green



27695A  
schwarz/black

27695R  
coyote tan



**Knieschützer**

Neopren, hoher Tragekomfort, extremer Schutz, mit verstellbaren Verschlüssen

**Knee pad**

neopren, high wearing comfort, extreme protection, adjustable fasteners



27683B  
oliv/OD green



27683A  
schwarz/black

27683T  
woodland



**Ellenbogenschützer**

aus Spezialschaum, hoher Tragekomfort, extremer Schutz, mit verstellbaren Klettverschlüssen

**Elbow pad**

high wearing comfort, extreme protection, with adjustable velcro



27693B  
oliv/OD green



27693A  
schwarz/black

27693T  
woodland



**Knieschützer**

aus Spezialschaum, hoher Tragekomfort, extremer Schutz, mit verstellbaren Verschlüssen

**Knee pad**

high wearing comfort, extreme protection, with adjustable fasteners



27687A  
schwarz/black



27687B  
oliv/OD green

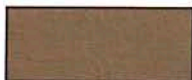

27687R  
coyote tan



**Elfenbogenschützer, „Defence“**

hoher Tragekomfort, extremer Schutz,  
mit verstellbaren Verschlüssen

**Elbow pad, „Defence“**

high wearing comfort, extreme protection,  
with adjustable closures



27697A  
schwarz/black



27697B  
oliv/OD green



27697R  
coyote tan



**Knieschützer, „Defence“**

hoher Tragekomfort, extremer Schutz,  
mit verstellbaren Verschlüssen

**Knee pad, „Defence“**

high wearing comfort, extreme protection,  
with adjustable closures



27699A  
schwarz/black



27699B  
oliv/OD green



**Knieschützer, „Protect“**

hoher Tragekomfort, extremer Schutz,  
mit verstellbaren Verschlüssen

Material: EVA, PU

(Ethylen-Vinylacetat, Polyurethan)

**Knee pad, „Protect“**

high wearing comfort, extreme protection,  
with adjustable closures







**27761**  
**Beil aus Guss-Stahl**  
mit Gummigriff, Länge ca. 29 cm  
**Camping axe, cast steel**  
rubber handle, length: ca. 29 cm

**27763**  
**Camping Beil**  
mit Gummigriff, Länge ca. 33 cm  
**Camping axe**  
rubber handle, length: ca. 33 cm



**27767**  
**Deluxe Fiberglass Axt**  
Länge ca. 36 cm  
**Deluxe fiberglass axe**  
length: ca. 36 cm



**27769**  
**Carbon-Beil**  
mit Gummigriff, Länge ca. 35 cm  
**Carbon axe**  
rubber handle, length: ca. 35 cm





27773

**US Pickel**

oliv, Metall, mit Holzstiel,  
Spitzhacke und Flachhacke, US Mod.

**G.I. style pick mattock**

OD green, metal, wooden handle,  
pickaxe and flathack, US Mod.

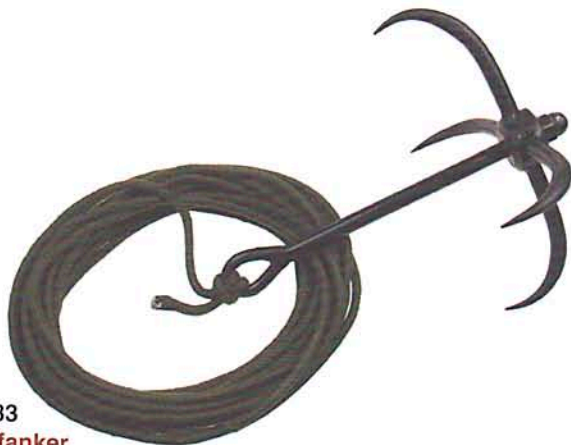

27783

**Wurfanker**

schwarz, Höhe: 26 cm, Durchmesser: 22 cm, mit 10 m Seil, oliv, mit 4 Spitzen,  
am Hacken verschraubt, mit großem Auge zur Befestigung des Seils

Material Anker: Eisen, Material Seil: Polyester

**Anchor**

black, height: 26 cm, diameter: 22 cm, with 10 m rope, OD green,  
stabil throwanchor with 4 peaks, screwed on the hook,  
with big eye to fasten the rope

material anchor: iron, material rope: polyester



27888

**Spiral-Hering**

Metall, 40 cm

**Spiral screw stake**

metal, 40 cm

27890

**Spiral-Hering**

Metall, mit Plastikgriff, 45 cm

**Spiral screw stake**

metal, with plastic handle, 45 cm

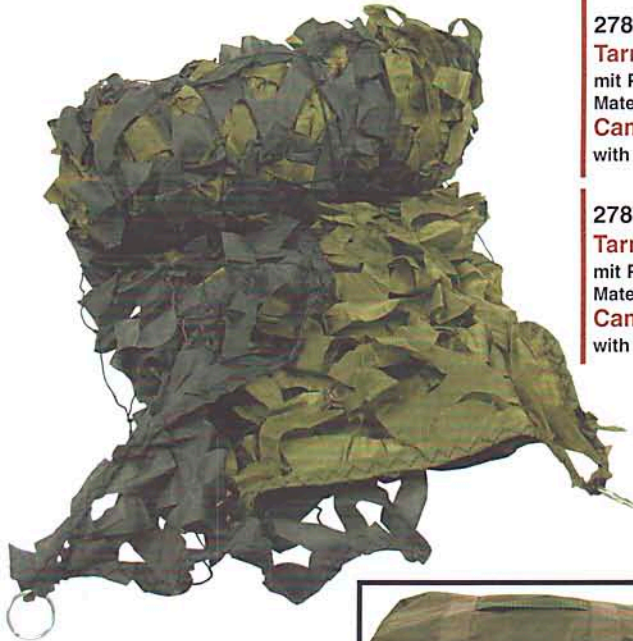

**27871B** oliv/OD green  
**Tarnnetz, 3 x 2 m**  
mit PVC-Tragebeutel  
Material: 100 % Polyester  
**Camo net, 3 x 2 m**  
with PVC bag

**27873B** oliv/OD green  
**Tarnnetz, 6 x 3 m**  
mit PVC-Tragebeutel  
Material: 100 % Polyester  
**Camo net, 6 x 3 m**  
with PVC bag



**27871L** weiß/white  
**Tarnnetz, 3 x 2 m**  
mit PVC-Tragebeutel  
Material: 100 % Polyester  
**Camo net, 3 x 2 m**  
with PVC bag



**27869**  
**Tarnnetz, 3 x 6 m**  
tarn, mit Netz  
Material: 100 % Polyester  
**Camo net, 3 x 6 m**  
camo, with net



**27875G**  
**Tarnnetz, 2 x 3 m**  
hunter-braun, mit PVC-Tragebeutel  
Material: 100 % Polyester  
**Camo net, 2 x 3 m**  
hunter-brown, with PVC bag





27993

**Vorhängeschloß**

Metall, mit 3 Schlüsseln  
Größe/Size: 4,5 x 2,5 cm  
**Padlock**  
metal, with 3 keys

27994

**Vorhängeschloß**

Metall, mit 3 Schlüsseln  
Größe/Size: 6 x 4 cm  
**Padlock**  
metal, with 3 keys



27996

**Waffen-Seil-Schloß**

mit Schlüsseln  
**Cable lock**  
with keys



27998

**Waffenschloß**

Abzugschloß, mit Schlüsseln  
**Trigger lock**  
with keys



27997

**Waffenschloß**

mit Zahlenschloß  
**Trigger lock**  
with combination lock



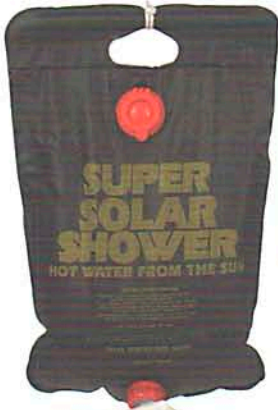

37603

**Solardusche**

10 Liter Inhalt, einseitig schwarz beschichtetes Polyneyl, stabile Aufhängung, Schlauch und Ventilduschkopf, zusammenrollbarer Sack

**Solar shower**

10 l, on-sided black coated poly, solid suspension, flexible tube and valve shower head, bag, easy to roll up



37613

**Solardusche**

20 Liter Inhalt, einseitig schwarz beschichtetes Polyneyl, stabile Aufhängung, Schlauch und Ventilduschkopf, zusammenrollbarer Sack

**Solar shower**

20 l, on-sided black coated poly, solid suspension, flexible tube and valve shower head, bag, easy to roll up



37623

**Solardusche**

40 Liter Inhalt, einseitig schwarz beschichtetes Polyneyl, Aufhängvorrichtung, Schlauch mit Duschkopf, zusammenrollbarer Sack

**Solar shower**

40 l, on-sided black coated poly, solid suspension, flexible tube and valve shower head, bag, easy to roll up





**28203**  
**Gliederkette**  
 Karabiner/Leder  
**Chain**  
 carabiner/leather



**28143N**  
 braun/brown



**28143A**  
 schwarz/black

**Lederband**  
 Länge: ca. 1 m  
**Leather strap**  
 length: ca. 1 m



**28243**  
**Patronenschlüsselanhänger**  
 mit Karabinerhaken, Patronenlänge: 6 cm  
**Key chain with carabiner**  
 length of bullet: 6 cm



**37553**  
**Ausscheider-Maßband**  
 mit Metallhalter u. Kette  
**Measuring tape**  
 with metal holder and chain



**28213**  
**Sicherungskette für Pistole**  
 Metallclip und Karabiner,  
 Länge: 55 cm  
**Security chain for gun**  
 metalclip and carabiner,  
 length: 55 cm



**28501B**  
**Spanngurt**  
 oliv, 2 St./Set, Zurrkraft 600 kg,  
 25 mm breit, 4,5 m lang  
**Lashing strap**  
 OD green, 2 pcs/set, 600 kg cap.,  
 25 mm broad, 4,5 m length



**28505B**  
**Spanngurt**  
 oliv, Zurrkraft 1200 kg,  
 38 mm breit, 4,8 m lang  
**Lashing strap**  
 OD green, 1200 kg cap.,  
 38 mm broad, 4,8 m length



**28701B**  
 oliv/OD green



**28701A**  
 schwarz/black

**Kapselgehörschutz**  
 universal, größenverstellbar,  
 klappbare Gehörkapsel,  
 Kopfbügel gepolstert,  
 CE-genormt EN 61000  
**Ear protection**  
 universal, size adjustable,  
 foldbar hearing capsule,  
 padded binaura,  
 CE-normed EN 61000



28301T  
woodland

**Tarnband**  
selbsthaftend  
Größe/Size: 5 cm x 4,5 m  
**Camo tape**  
self-adhesive



28301Z  
desert



28331G  
**Klebeband**  
hunterbraun  
Größe/Size: 5 cm x 5 m  
**Adhesive tape**  
hunterbrown



28311B  
oliv/OD green



28311F  
khaki



28311Q  
AT-digital



28311T  
woodland



28311U  
urban



28311V  
flecktarn/BW camo

**Klebeband Gewebe**  
Größe/Size: 5 cm x 10 m  
**Adhesive tape cloth**





29303  
chrom/chrome

**Handsellen**  
mit 2 Schlüssel  
**Handcuffs**  
with 2 keys



29313  
schwarz/black

29503

**Daumenschellen**  
Edelstahl, mit 2 Schlüssel  
**NIHT FÜR EXPORT!**  
**Thumb cuffs**  
stainless steel, with 2 keys  
**NOT FOR EXPORT!**



29403

**Handsellen, „Deluxe“**  
Stahl, vernickelt, mit 2 Schlüssel,  
mit „Double-Lock“  
**Handcuffs, „Deluxe“**  
steel, nickel plated, with 2 keys,  
with „Double-Lock“



29453

**Handsellen, Edelstahl**  
mit Sicherheitsrille, 2 Schlüssel,  
„Double-Lock“  
**Handcuffs, stainless steel**  
safety groove, with 2 keys,  
with „Double-Lock“



29473

**Handsellen, Doppelkette**  
stabile Ausführung, 2 Schlüssel,  
mit „Double-Lock“  
**Handcuffs, 2 chains**  
solid version, with 2 keys,  
with „Double-Lock“



29353  
rot/red



29354  
schwarz/black

**Handsellen, „Plüsch“**  
mit 2 Schlüssel, chrom,  
mit Fellüberzug  
**Handcuffs, „Plush“**  
with 2 keys, chrome,  
with plush





**29233**  
**Kunststoffhandschellen**  
 10 St./Pack, weiß  
 Größe/Size: 700 x 12 mm  
**Plastic handcuff**  
 10 pcs/pack, white



**29234**  
**Kunststoffhandschellen**  
 10 St./Pack, schwarz  
 Größe/Size: 800 x 12,7 mm  
**Plastic handcuff**  
 10 pcs/pack, black



**29235**  
**Kunststoffhandschellen**  
 10 St./Pack, gelb  
 Größe/Size: 550 x 12,5 mm  
**Plastic handcuff**  
 10 pcs/pack, yellow



**29493**  
**Fußschellen**  
 chrom, mit 2 Schlüssel  
 NICHT FÜR EXPORT!  
**Footcuffs**  
 chrome, with 2 keys  
 NOT FOR EXPORT!



**29633**  
**Handschellenetui**  
 Leder, schwarz  
**Handcuff case**  
 leather, black



**29643**  
**Handschellenetui**  
 Leder, schwarz  
**Handcuff case**  
 leather, black

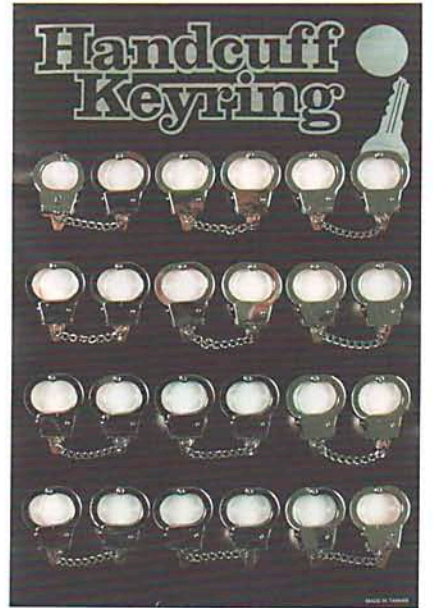

**29803**  
**Handschellen, Schlüsselanhänger**  
 12 St. auf Display, silber  
**Handcuffs key rings**  
 12 pcs/display, silver



**29653**  
**Handschellenetui**  
 Nylon, schwarz  
**Handcuff case**  
 nylon, black



**29663**  
**Handschellenetui**  
 Nylon, schwarz,  
 schnell zugänglich, durch offene Art  
**Handcuff case**  
 nylon, black,  
 easy access, because open style



30003A

**Laptop-Tasche**

schwarz, praktische Laptoptasche mit Tragegriff und Schultertrageriemen, eine Rückentasche, eine Deckelaußentasche, zwei Dokumententaschen und div. Kleinfächern, eine Dehnfalte mit Reißverschluss

Material: 100 % Nylon

Größe/Size: 38 x 12 x 31 cm

**Laptop bag**

black, with carrying handle and shoulder carrying strap, a back pocket, a bag with external lid, 2 document bags and div. little compartments, one stretchfold with zipper



30005T

woodland

30005V

flecktarn/BW camo

**Notebook-Tasche**

praktische Notebook-Tasche mit Tragegriff und verstellbarem Schultertrageriemen, transparentes Rückenfach mit Klettverschluss, 1 Innentasche mit RV, div. Kleinfächer und 3 Stiffächer, 2 Dokumentenfächer, 2 Metalldrehverschlüsse am Deckel

Material: 100 % Polyester

Größe/Size: 40 x 9 x 30 cm

**Notebook bag**

with carrying handle and adjustable shoulder-carrying strap, transparent back pocket with velcro, 1 inside pocket with zip, different small compartments and 3 pockets for pencils, 2 compartments for documents, 2 metal screw tops on the cover



30007A

**Einsatz-Tasche**

schwarz, gepostertes Innenfach, per Klett herausnehmbare Innenfachunterteilung mit div. Fächern, großes Rückfach mit div. Fächern und RV, 2 Seitenfächer mit Klett, 1 Frontfach mit Klett, 4 aufgesetzte Fronttaschen mit RV, abnehmbarer und längenverstellbarer Schultertragegurt, 2 Tragehenkel oben, Klettflausch an Fronttasche

Material: 100 % Polyester

**Operation bag**

black, internal padded comartment, detachable with velcro, inner subdivision with different compartments, big back compartment with different compartments and zipper, 2 side compartments with velcro, 1 front compartment with velcro, 4 patch front pockets with zipper, detachable and length adjustable shoulder strap, 2 carrying handles on the top, velcro fleece at the front pocket





30022

**Schultertasche**

„Pure Trash“, oliv, 1 verstellbarer Schulterriemen und Beingurt, Hauptfach mit Reißverschluss, 3 aufgesetzte Fronttaschen mit Klett- bzw. Druckknopfverschluss, 1 Einschubtasche und 1 Handytasche innen, 1 Innentasche mit Reißverschluss

Material: 100 % Nylon  
Größe/Size: ca. 20 x 6 x 30 cm

**Shoulderbag**

OD green, 1 adjustable shoulder strap and leg belt, main compartment with zipper, 3 external front pockets with velcro and snap closure, 1 batch pocket and 1 cell phone pocket, 1 inside pocket with zipper



30024

**Handtasche**

„Pure Trash“, oliv, mittel, 1 verstellbarer Schulterriemen, 2 Tragegriffe, Hauptfach mit Reißverschluss und Druckknöpfe, 1 Front- und 1 Rückentasche mit Klett, 1 Einschubfach mit Klett und 1 Handytasche innen, 1 Innentasche mit Reißverschluss

Material: 100 % Nylon  
Größe/Size: ca. 37 x 15 x 32 cm

**Handbag**

OD green, 1 adjustable shoulder strap, 2 carrying handles, main compartment with zipper and snaps, 1 front and 1 back pocket with velcro, 1 batch pocket with velcro and 1 cell phone pocket inside, 1 inside pocket with zipper



30021

**Bauchtasche**

„Pure Trash“, oliv, verstellbarer Hüftgurt mit Steckverschluss, Hauptfach mit Reißverschluss, 3 aufgesetzte Fronttaschen und 1 Rückentasche mit Reißverschluss, 1 Innentasche mit Reißverschluss und 1 Handytasche innen

Material: 100 % Nylon  
Größe/Size: ca. 31 x 13 x 20 cm

**Hip bag**

OD green, adjustable belt with plug-in closure, major compartment with zipper, 3 external front pockets and 1 back pocket with zipper, 1 pocket inside with zipper and 1 cell phone pocket



30023

**Handtasche**

„Pure Trash“, oliv, klein, 1 verstellbarer Schulterriemen, 2 Tragegriffe, Hauptfach mit Reißverschluss, 1 Fronttasche mit Klett, 1 Rückentasche mit Reißverschluss, 2 Einschubfächer und 1 Handytasche innen, 1 Innentasche mit Reißverschluss

Material: 100 % Nylon  
Größe/Size: ca. 34 x 10 x 25 cm

**Handbag**

OD green, 1 adjustable shoulder strap, 2 carrying straps, main compartment with zipper, 1 front pocket with velcro, 1 back pocket with zipper, 2 batch pockets and 1 cell phone pocket inside, 1 inside pocket with zipper



30025

**Handtasche**

„Pure Trash“, oliv, groß, 1 verstellbarer Schulterriemen, 2 Tragegriffe, Hauptfach mit Reißverschluss und Druckknöpfe, 1 Front- und 1 Rückentasche mit Reißverschluss, 1 Einschubfach mit Klett und 1 Handytasche innen,

1 Innentasche mit Reißverschluss

Material: 100 % Nylon

Größe/Size: ca. 45 x 22 x 25 cm

**Handbag**

OD green, 1 adjustable shoulder strap, 2 carrying handles, main compartment with zipper and snaps, 1 front and 1 back pocket with zipper, 1 batch pocket with velcro and 1 cell phone pocket inside, 1 inside pocket with zipper



30026

**Rucksack**

„Pure Trash“, oliv, gepolsterte, verstellbare Schultergurte, 1 Tragegriff, Hüftpolsterung, Hauptfach mit Reißverschluss, 1 Front- und 1 Deckeltasche mit Reißverschluss, 2 Seitentaschen mit Reißverschluss, 2 Netztaschen seitlich mit Kordelzug, Innentasche mit Reißverschluss, 1 Einschubfach und 1 Handytasche innen

Material: 100 % Nylon

Größe/Size: ca. 30 x 25 x 50 cm

**Rucksack**

OD green, adjustable and padded shoulder straps, 1 carrying handle, padding for hips, main compartment with zipper, 1 front and 1 cover pocket with zipper, 2 side pockets with zipper, 2 mesh pockets sideways with pull cord, inside pocket with zipper, 1 batch pocket and 1 cell phone pocket inside



30034

**Rucksack**

„Pure Trash“, oliv, gepolsterte, verstellbare Schultergurte, 1 Tragegriff, Rückenpolster, Hauptfach mit Reißverschluss, 1 Fronttasche und 2 Seitentaschen mit Reißverschluss, 1 kleine aufgenähte Tasche mit Klett- und Kordelverschluss seitlich, 1 Innentasche mit Reißverschluss

Material: 100 % Nylon

Größe/Size: ca. 25 x 25 x 45 cm

**Rucksack**

OD green, padded and adjustable shoulder straps, 1 carrying handle, back cushion, main compartment with zipper, 1 front and 2 side pockets with zipper, 1 small appliqued pocket with velcro and cord closure sideways, 1 inside pocket with zipper



30031

**Handtasche**

„Pure Trash“, oliv, 1 verstellbarer Schulterriemen, 2 Tragegriffe, Hauptfach mit Reißverschluss, 1 Front- und 1 Rückentasche mit Reißverschluss, 1 Innentasche mit Reißverschluss und 1 Handytasche innen, mit Karabinerverschluss

Material: 100 % Nylon

Größe/Size: ca. 33 x 10 x 25 cm

**Handbag**

OD green, 1 adjustable shoulder strap, 2 carrying handles, main compartment with zipper, 1 front and 1 back pocket with zipper, 1 inside pocket with zipper and 1 cell phone pocket inside, with carabiner closure



30032

**Bauchtasche**

„Pure Trash“, oliv, verstellbarer Hüftgurt mit Steckverschluss, Hauptfach mit Reißverschluss, 1 aufgesetzte Fronttasche mit Klett- und Metallschnalle, 1 Handytasche mit Metallverschluss, mit Karabinerverschluss

Material: 100 % Nylon

Größe/Size: ca. 19 x 7 x 15 cm

**Belt bag**

OD green, adjustable hip belt with plug closure, main compartment with zipper, 1 external front pocket with velcro and metal buckle, 1 cell phone pocket with metal closure, with carabiner closure



30033

**Handtasche**

„Pure Trash“, oliv, 1 verstellbarer Schulterriemen, 2 Tragegriffe, Hauptfach mit Reißverschluss, 2 Front- und 1 Rückentasche mit Reißverschluss, 1 Innentasche mit Reißverschluss und 1 Handytasche innen, 1 kleine aufgenähte Tasche mit Klett- und Kordelverschluss auf Fronttasche

Material: 100 % Nylon

Größe/Size: ca. 40 x 10 x 30 cm

**Handbag**

OD green, 1 adjustable shoulder strap, 2 carrying handles, main compartment with zipper, 2 front and 1 back pocket with zipper, 1 inside pocket with zipper and 1 cell phone pocket inside, 1 small applied pocket with zipper cord closure positioned on the front pocket





**30103B**  
oliv/OD green



**30103A**  
schwarz/black



**30103D**  
bordeaux



**30103F**  
khaki



**30103G**  
blau/blue



**30103I**  
rot/red



**30103L**  
natur/nature



**30103P**  
oliv-stonewashed/  
OD green-stonewashed



**BW Kampftasche, klein**

Canvas, mit verstellbarem Schultertrageriemen,

Gürtelbefestigung, 3 Innentaschen

Material: 100 % Baumwolle/Cotton

Größe/Size: ca. 21 x 23 x 8 cm

**BW combat pack, small**

canvas, with adjustable shoulder straps,  
belt fixing, 3 inside pockets





30113A  
schwarz/black



30113B  
oliv/OD green



30113F  
khaki



30113G  
blau/blue



30113P  
oliv-stonewashed/  
OD green-stonewashed



30113T  
woodland-stonewashed



**BW Kampftasche, groß**

Canvas, mit verstellbarem Schultertragegurt,  
3 Innentaschen, 1 Außenfach, Tragegriff

Material: 100 % Baumwolle/Cotton

Größe/Size: ca. 34 x 24 x 12 cm

**BW combat pack, large**

canvas, with adjustable shoulder straps,  
3 inside pockets, 1 external compartment,  
carrying handle





30213V

**BW Aktentasche, „Laptop“**

flecktarn, Cordura, 2 Hauptfächer mit extra Laptopfach und diversen funktionalen Einzelfächern, 2 große Fronttaschen mit Klettverschluss, 1 Rückenfach mit RV aussen, abnehmbarer Schultertrageriemen, verstellbarer Deckel mit doppeltem Clipverschluss

Material: 100 % Polyamid (Cordura)

Größe/Size: ca. 45 x 38 x 13 cm

**BW briefcase, „Laptop“**

BW camo, Cordura, 2 main compartments with extra Laptopcompartment diverse functional separate compartments, 2 large front pockets with velcro, 1 pouch on back with external zipper, detachable shoulder straps, adjustable cover with double clip



30233V

**BW Kampfrucksack**

flecktarn, klein, Cordura, mit Alu-Aussteifung, gepolsterte Rückentrag Gurte, 2 Innenfächer, 2 große seitliche Außentaschen, 1 großes Separatfach im Bodenteil, Deckel mit Klett Tasche u. aufgesetzter Zusatztasche, Befestigungsgurte an Vorderseite, Boden und Deckel, praktische Kunststoffschnellverschlüsse, Klettband für Namensschild am Deckel, ca. 25 Liter Fassungsvermögen

Material: 100 % Polyamid (Cordura)

**BW combat back pack**

BW camo, Cordura, with aluminium bracing, padded back carrying belts, 2 inside pockets, 2 large external separated pockets sideways, 1 large separated pocket in the bottom, cover with velcro pocket and external extra pocket, fixing belts on the front side, bottom and cover, effectively fast plastic zippers, velcro for rank insignia at the cover, about 25 ltr capacity



30243V

**BW Kampfrucksack**

flecktarn, groß, Cordura, mit Alu-Aussteifung, gepolsterte Rückentrag Gurte, 2 Innenfächer, 2 große seitliche Außentaschen, 1 großes Separatfach im Bodenteil, Deckel mit Klett Tasche u. aufgesetzter Zusatztasche, Befestigungsgurte an Vorderseite, Boden und Deckel, praktische Kunststoffschnellverschlüsse, ca. 65 Liter Fassungsvermögen

Material: 100 % Polyamid (Cordura)

**BW combat back pack**

BW camo, Cordura, with aluminium bracing, padded back carrying belts, 2 inside pockets, 2 large external separated pockets sideways, 1 large separated pocket in the bottom, cover with velcro pocket and external extra pocket, fixing belts on the front side, bottom and cover, effectively fast plastic closures, about 65 ltr capacity





**30253V**  
flecktarn/BW camo



**30253A**  
schwarz/black



**30253B**  
oliv/OD green



**30253O**  
BW wintertarn/BW winter camo



**30253J**  
CZ tarn/CZ camo



**30253N**  
snow camo



**BW Kampfrucksack, groß**

Mod., mit Alu-Aussteifung, gepolsterte Rückentraggurte, 2 Innenfächer, 2 große seitliche Außentaschen, 1 großes Separatfach im Bodenteil, Deckel mit Klett Tasche u. aufgesetzter Zusatztasche, Befestigungsgurte an Vorderseite, Boden und Deckel, praktische Kunststoffschnellverschlüsse, ca. 65 Liter Fassungsvermögen

Material: 100 % Polyester

**BW combat back pack, big**

with aluminium bracing, padded back carrying belts, 2 inside pockets, 2 large external separated pockets sideways, 1 large separated pocket in the bottom, cover with velcro pocket and external extra pocket, fixing belts on the front side, bottom and cover, effectively fast plastic closures, about 65 ltr capacity



**30253Y**  
BW tropentarn/BW tropical camo



**30253T**  
woodland





30263A  
schwarz/black



30263B  
oliv/OD green



30263I  
CCE-camo



30263N  
snow camo



30263T  
woodland



30263V  
flecktarn/BW camo



30263Q  
AT-digital

**Rucksack, „Combo“**

2-geteiltes Hauptfach mit internen Befestigungs- bzw. Kompressionsriemen, 2 Schlauchöffnungen mit Klettdeckung oben, Frontfach mit Reißverschluss, 4 seitliche Außentaschen mit Plastikverschluss, Tragegriff, 2 kleine Außentaschen mit Klettverschluss, Trage- und Bauchgurt, sowie Rückenteil gepolstert, ca. 40 Liter Fassungsvermögen

Material: 100 % Nylon

Größe/Size: 40 x 50 x 22 cm

**Rucksack, „Combo“**

two-part main compartment with internal fixing and compression straps, 2 pipe vents with velcro cover at top, front compartment with zipper, 4 external pockets sideways plastic closure, carrying handle, 2 small external pockets with velcro, both carrying and body belt and back part padded, about 40 ltr capacity





30273B  
oliv/OD green



30273A  
schwarz/black



30273V  
flecktarn/BW camo



**Rucksack, „Tactical“**

mit aufwendiger Rückenpolsterung für guten Tragekomfort, Aluaussteifung am Rücken, gepolsterte, verstellbare Schulter und Hüftgurte, Tragegriff, 1 aufgesetzte Fronttasche incl. Staunetz, 2 Seitentaschen, 1 Deckeltasche außen, 1 Schmutzwäschefach, 2 Kompressionsgurte, Verschluss mit Zugband oder Plastikverschlüsse möglich, ca. 55 Liter Fassungsvermögen  
Material: 100 % Nylon

**Rucksack, „Tactical“**

with elaborate back padding for good wearing comfort, aluminium constraints at the back, padded, adjustable shoulder- and hip straps, carry handle, one put on frontpocket incl. storagenet, 2 side pockets, 1 lid pocket outside, 1 dirty laundry compartment, 2 compression straps, closure with strap or plastic clips possible, about 55 ltr capacity



30283B  
oliv/OD green



30283A  
schwarz/black



30283V  
flecktarn/BW camo



2 abnehmbare Seitentaschen, als Daypack verwendbar!

**BW Rucksack, „Mountain“**

2 abnehmbare Seitentaschen, als Daypack verwendbar, Schmutzwäschefach am Boden, Beckengurt und Rückenteil gepolstert, höhenverstellbare, gepolsterte Trageriemen (VARIO-BACK-SYSTEM), Deckelfach mit Reißverschluss und Kompressionsriemen, diverse Schlaufen an den Seitenfächern, Brustgurt, im Rückenbereich eingearbeitetes Metallgestell, 80 Liter Fassungsvermögen

Material: 100 % Polyester

Größe/Size: Rucksack/Backpack: 38 x 22 x 70 cm

Seitentasche/Side pocket: 20 x 10 x 40 cm

**BW backpack, „Mountain“**

2 sidepockets removable, usable as Daypack, laundry compartment at the bottom, pelvic belt and back part padded, in height adjustable and padded carrying straps, (VARIO-BACK-SYSTEM), various clews fixed on the side pockets, chest strap, incorporated metal frame in back area, about 80 ltr capacity



30291V

**BW Gebirgsrucksack**

klein, flecktarn, Cordura, Plastikverschlüsse, gepolsterte Rückentragegurte, verstärktes Bodenteil aus wasserdichtem PVC, 2 aufgesetzte Seitentaschen, 1 Innenfach, Tragegriff, ca. 30 Liter Fassungsvermögen  
Material: 100 % Polyamid (Cordura)

**BW mountain backpack**

BW camo, Cordura, plastic closure, padding shoulder straps, reinforced bottom made of waterproof PVC, 2 external sidepockets, 1 inside compartment, carrying handle, about 30 ltr capacity



**BW Gebirgsrucksack**

neue Ausführung, Plastikverschluss, Schulterpolster, Mod., verstärktes Bodenteil aus wasserdichtem PVC, 2 aufgesetzte Seitentaschen, 1 Innenfach, Tragegriff, ca. 30 Liter Fassungsvermögen  
Material: 100 % Baumwolle/Cotton

**BW mountain backpack**

new version, plastic closure, shoulder paddings, reinforced bottom made of waterproof PVC, 2 external side pockets, 1 inside compartment, carrying handle, about 30 ltr capacity



30293B  
oliv/OD green



30293V  
flecktarn/BW camo



30293A  
schwarz/black



30303B

**BW Gebirgsrucksack.**

altes Mod., oliv, klein, mit gepolsterten Rückentragegurte, Tragegriff, 2 aufgesetzte Außentaschen, Lederbebanderung, ca. 30 Liter Fassungsvermögen  
Material: 100 % Baumwolle/Cotton

**BW mountain backpack**

OD green, small, padding shoulder straps, carrying handle, 2 external pockets, leather stripes, about 30 ltr capacity





30313A  
schwarz/black



30313B  
oliv/OD green



30313V  
flecktarn/BW camo



**Rucksack, „Alpin 110“**

2 abnehmbare Seitentaschen, Schmutzwäschefach am Boden, Beckengurt und Rückenteil gepolstert, höhenverstellbare, gepolsterte Trageriemen, Brustgurt, div. Schlaufen an den Seitenfächern, im Rückenbereich eingearbeitetes Metallgestell, ca. 110 Liter Fassungsvermögen  
Material: 100 % Nylon 1000 D

**Backpack, „Alpin 110“**

2 detachable side bags, laundry pocket at the bottom, pelvic belt and back part padded, in height adjustable and padded carrying straps, chest strap, various clews fixed on the side pockets, incorporated metal frame in the back area, about 110 ltr capacity



30323A  
schwarz/black



30323B  
oliv/OD green

**BW Rucksack**

Canvas, Mod., mit Träger (wie BW Packtasche), Tragegurte und Tragegriff, 3 große Außentaschen, 2 Innenfächer, ca. 30 Liter Fassungsvermögen  
Material: 100 % Baumwolle/Cotton

**BW backpack**

canvas, mod., with strap (like BW saddle-bag), carrying straps and handle, 3 big external pockets, 2 inside compartment, about 30 ltr capacity





30333L  
vegetato



30333A  
schwarz/black



30333B  
oliv/OD green



30333I  
CCE tarn/CCE camo



30333J  
CZ tarn/CZ camo



30333Q  
AT-digital



30333R  
coyote tan



30333T  
woodland



30333V  
flecktarn/BW camo



**US Rucksack, „Assault I“**

2 große Hauptfächer mit Reißverschluss und Netzfächern, 2 große Frontfächer mit Reißverschluss, verstellbare und gepolsterte Schultergurte mit D-Ringen, integriertes Klettfach für einen Hydropack am Rücken, div. Molle-Aufnahmepunkte, Tragegriff, atmungsaktiver Rücken- und Schulterriemenmesh, ca. 30 Liter Fassungsvermögen

Material: 100 % Nylon

Größe/Size: 45 x 25 x 20 cm

**Backpack, „Assault I“**

2 big pockets with zipper and net, 2 big front pockets with zipper, adjustable and padded shoulder belts, with D-rings, interior hydration pouch at the back, different Molle-position points, carry handle, breathable back and shoulder strap, ca. 30 ltr capacity



30343Q  
AT-digital



30343A  
schwarz/black



30343B  
oliv/OD green



30343T  
woodland



30343V  
flecktarn/BW camo



**US Rucksack, „Assault II“**

1 großes Hauptfach mit Reißverschluss und Netzfach, 2 große Frontfächer mit Reißverschluss, gepolsterte und verstellbare Schultergurte mit D-Ringen, integriertes Klettfach für einen Hydropack am Rücken, div. Molle-Aufnahmepunkte, verstellbarer Beckengurt abnehmbar, Tragegriff

Material: 100 % Nylon

Größe/Size: 48 x 30 x 30 cm

**Backpack, „Assault II“**

1 big pocket with zipper and net, 2 big front pockets with zipper, adjustable and padded shoulder belts with D-rings, interior hydration pouch at the back, different Molle-position points, adjustable lap belt detachable, carry handle

30481V

## Waschzeugtasche

flecktarn, Cordura, 6 praktische Einstecktaschen für Waschzeug innen, 2 Innenfächer mit RV, Tragegriff, 2 seitliche Außentaschen, 1 Tasche mit Klett auf Rückseite, 1 Deckelaussentasche mit RV, Klettband für Namensschild außen, Kunststoffspiegel, Aufhängehaken

Material: 100 % Polyamid (Cordura)

Größe/Size: 45 x 23 cm offen/open

26 x 23 cm geschlossen/closed

## Washbag

BW camo, Cordura, 6 practical inside pockets for washing things, 2 inside compartments with zippers, carrying handle, 2 side external pockets, 1 pocket with velcro at the back, 1 cover pouch with zipper, velcro for label outside, plastic mirror, suspension hook



30491B  
oliv/OD green



30491A  
schwarz/black



## Waschzeugtasche

rollbar, 5 praktische Taschen für Waschzeug, Kunststoffspiegel abnehmbar per Klett, Aufhängehaken

Material: Polyester

Größe/Size: 42 x 26 cm offen/open

16 x 26 cm geschlossen/closed

## Washbag

rollable, 5 practical pockets for washing things, plastic mirror, detachable with velcro, suspension hook



30493B

## BW Waschzeugtasche

oliv, 12 praktische Taschen für Waschzeug, Kunststoffspiegel, Aufhängehaken und dreiseitigem Reißverschluss

Material: Nylon

Größe/Size: 32 x 25 x 10 cm

## BW washbag

OD green, 12 functional pockets for washing things, plastic mirror, hanging hook and trilateral zipper

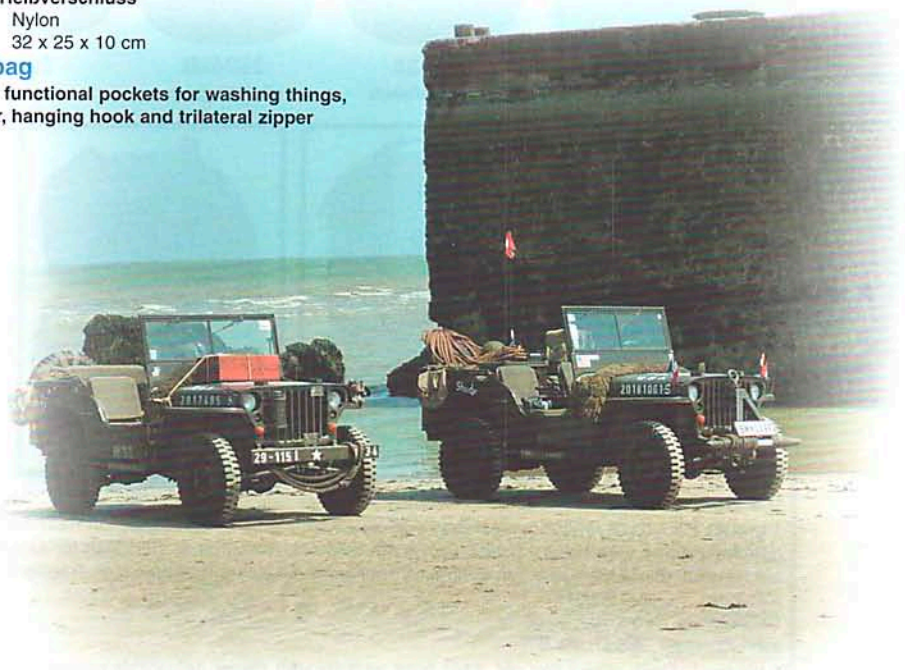



30505B

**US Seesack**

oliv, 1 Trageriemen, 1 Tragegriff  
 Material: 100 % Baumwolle/Cotton  
 Größe/Size: 35 x 20 x 90 cm offen/open

**US Duffel bag**

OD green, 1 strap, 1 carrying handle



30510B

**Netzbeutel mit Kordel**

oliv  
 Material: 100 % Nylon  
 Größe/Size: 50 x 74 cm

**Net bag with cord**

OD green



30513B

**Falteimer**

oliv, praktischer Falteimer mit Tragehenkel,  
 Fassungsvermögen 10 Liter,  
 Durchmesser: 22 cm, Höhe: 27 cm

**Folding bin**

OD green, practical folding bucket with  
 carrying handle, capacity 10 liters,  
 diameter: 22 cm, height: 27 cm



30515B

**Faltschüssel**

oliv, praktische Faltschüssel mit Tragehenkel,  
 Fassungsvermögen ca. 3,5 Liter,  
 Durchmesser: 22 cm, Höhe: 11,5 cm

**Folding bowl**

OD green, practical folding bowl with  
 carrying handle, capacity ca. 3,5 liters,  
 diameter: 22 cm, height: 11,5 cm

**Waterproof**



30520B

**Transportbeutel**

wasserdicht, Rip Stop, oliv, 10 Liter,  
 wasserdichtes Polyestergewebe,  
 mit Schnappverschluss  
 Höhe: 57 cm, Durchmesser: 30 cm

**Duffel bag**

waterproof, Rip Stop, OD green, 10 liter,  
 polyester texture, with snap fastener  
 height: 57 cm, diameter: 30 cm



30521B

**Transportbeutel**

wasserdicht, Rip Stop, oliv, 20 Liter,  
 wasserdichtes Polyestergewebe,  
 mit Schnappverschluss  
 Höhe: 66 cm, Durchmesser: 42 cm

**Duffel bag**

waterproof, Rip Stop, OD green, 20 liter,  
 polyester texture, with snap fastener  
 height: 66 cm, diameter: 42 cm

**Waterproof**



30535

**Wasserdichte Dokumentenhülle**

transparent, mit Trageband, Klettverschluss  
 Größe/Size: 18 x 25 cm

**Waterproof document cover**

transparent, lanyard, velcro closure



**Waterproof**



30523B  
oliv/OD green



30523A  
schwarz/black



30523T  
woodland

**Transportbeutel, klein**  
wasserdichtes Polyestergewebe,  
mit Schnappverschluss  
Höhe: 42 cm, Durchmesser: 30 cm  
**Duffel bag, small**  
waterproof polyester texture,  
with snap fastener  
height: 42 cm, diameter: 30 cm

**Transportbeutel, groß**  
wasserdichtes Polyestergewebe,  
mit Schnappverschluss  
Höhe: 87 cm, Durchmesser: 60 cm  
**Duffel bag, big**  
waterproof polyester texture,  
with snap fastener  
height: 87 cm, diameter: 60 cm



30525T  
woodland



30525B  
oliv/OD green



30525A  
schwarz/black



30543  
**TPU-Beutel**  
2,5 Liter, mit Trinkschlauch,  
für Trinkrucksack, Art.-Nr. 30553  
**TPU bladder**  
2,5 liter, flexible drinking tube,  
for hydration pack, item no. 30553



30549  
**Reinigungsset für Trinkbeutel**  
besteht aus 3 Reinigungsbürsten:  
1 x Reinigung des Wasserbehälters,  
1 x Reinigung des Mundstücks,  
1 x Reinigung des Trinkschlauchs,  
Reinigungsbürsten: rostfreie Edelstahlteile  
Borsten: Nylon  
**Bladder cleaning set**  
consists of 3 cleaning brushes:  
1 x cleaning of the water container,  
1 x cleaning of the mouthpiece,  
1 x cleaning of the drinking pipe,  
cleaning brushes: stainless steel parts,  
bristle: nylon



**Trinkrucksack**

mit TPU-Beutel, 2,5 Liter, mit Trinkschlauch, mit Beckengurt und gepolsterten Träger, Netzinntasche mit zwei Reißverschlüssen, Tragehenkel und Netztasche an Frontseite, gepolstertes Rückenteil

Material: 100 % Polyester

Größe/Size: 12 x 19 x 45 cm

**Hydration pack**

with TPU bag, 2,5 liter, with flexible drinking tube, with waist belt and padded straps, inside net pocket with 2 zippers, carry handle and net pocket on the front side, padded back part

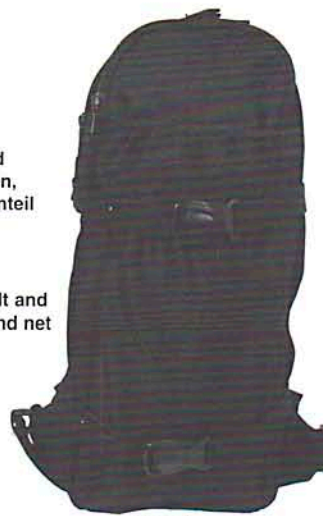

30553A  
schwarz/black



30553B  
oliv/OD green



30554R  
coyote tan

**Trinkrucksack, „Extreme“**

mit TPU-Beutel, 2,5 Liter, Trinkschlauch mit wechselbarem Mundstück und Abdeckkappe, 2 Tragehenkel, Schulter- und Brustgurt längenverstellbar, gepolstertes Rückenteil mit Staufach, 4 D-Ringe zur Befestigung am Rucksack

Material: 100 % Polyester

Größe/Size: 44 x 22 x 2,5 cm

Gewicht/Weight: ca. 540 g

**Hydration pack, „Extreme“**

with bladder „TPU“, flexible drinking tube with changeable bite valve and cover cap, 2 carry handle, shoulder and chest strap adjustable, padded back part with storage compartment, 4-D rings to fixing backpack



30554A  
schwarz/black



30554B  
oliv/OD green



30554Q  
AT-digital



30554T  
woodland

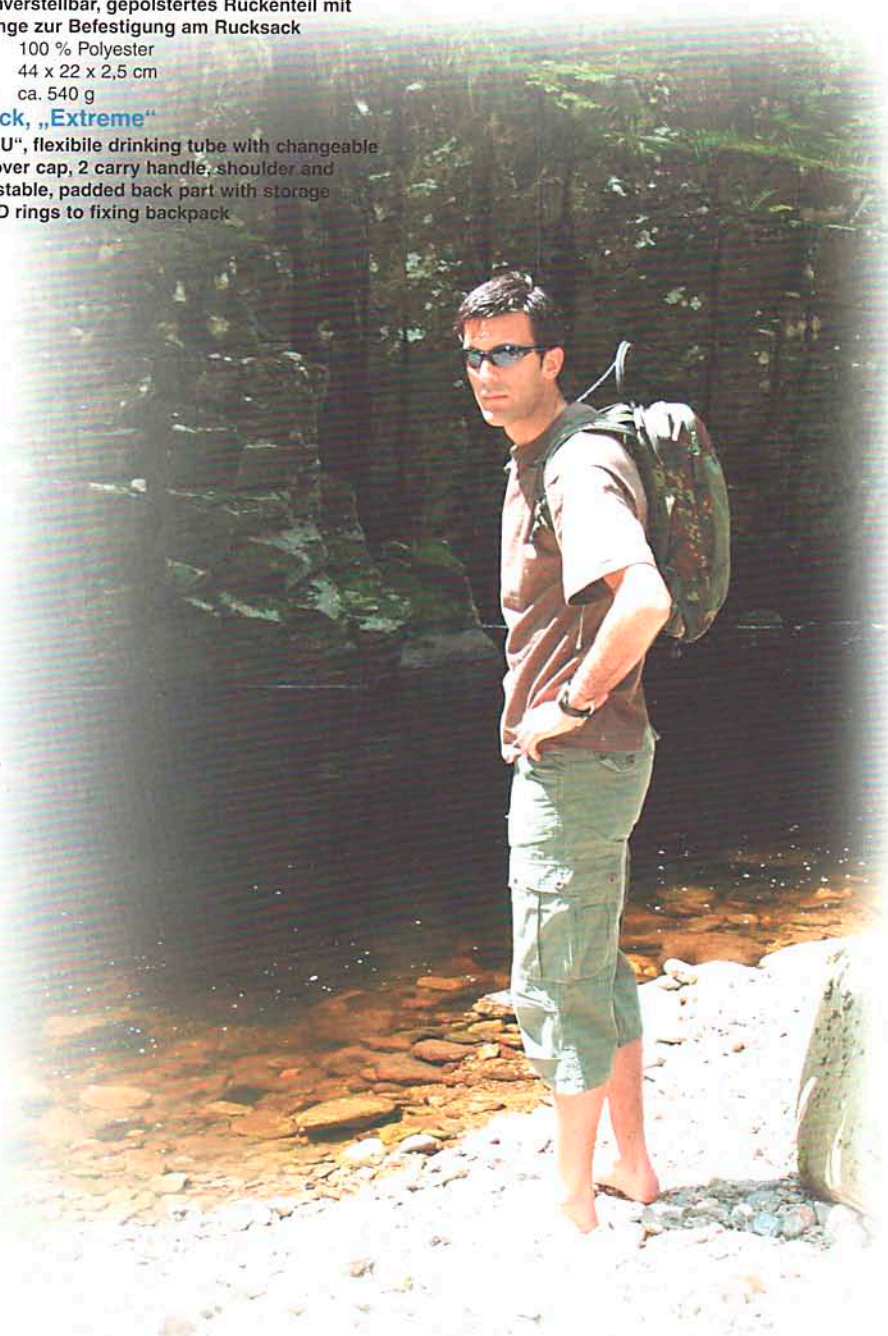



30573T

**US Pilotenhelmtasche**

woodland, großes Hauptfach mit RV, 2 Frontfächer mit Klett und Druckknopf, Tragegriffe, 2 D-Ringe, 1 Karabinerhaken  
Material: 100 % Polyester

Größe/Size: 46 x 40 cm

**US pilot helmet bag**

woodland, large main compartment with zipper, 2 front compartments with velcro and press buttons, carrying handle, 2 D-rings, 1 carabiner



30650B  
oliv/OD green



30650A  
schwarz/black

**Werkzeugtasche**

2 Innenfächer, 2 Tragegriffe, abgedecker Reißverschluss

Material: 100 % Polyester

Größe/Size: 51 x 18 x 21 cm

**Tool bag**

2 inner compartments, 2 carrying handles, covered zipper



30651V

**BW Sporttasche**

klein, flecktarn, mit Tragegriffen, Mod.,

Material: 100 % Nylon

Größe/Size: 47 x 23 x 15 cm

**BW sports bag**

small, BW camo, with carrying handles



30655J

**CZ Feldtasche**

Typ 95 CZ tarn, 2 Tragegriffe

Material: 50 % Nylon, 50 % Baumwolle/Cotton

Größe/Size: 62 x 28 x 30 cm

**CZ field bag**

Typ 95 CZ camo, 2 carrying handles





30600B  
oliv/OD green



30600A  
schwarz/black

30600R  
coyote tan

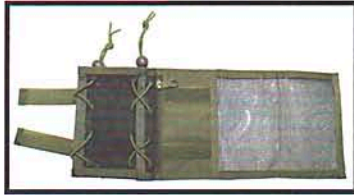

**Armtasche**

Geld- und Kartenfach, weitenverstellbar durch elastisches Kordelband mit Stopper, Kartenfach transparent, Geldfach mit RV, 2 Stiftehalter  
Material: 100 % Polyester

**Arm bag**

money- and map pocket, length adjustable with elastic cord with stopper, transparent card compartment, money compartment with zipper, 2 pen holder



30601T  
woodland



30601A  
schwarz/black



30601B  
oliv/OD green



30601Q  
AT-digital



30601R  
coyote tan



30601V  
flecktarn/BW camo



**Handyhalter, „MOLLE“**

größenverstellbar, quer und längs tragbar, Clipverschluss  
Material: 100 % Polyester  
Größe/Size: 12 x 6 cm

**Mobile phone holder, „MOLLE“**

resizable, portable diagonally and alongside, clip closure



30604T  
woodland



30604A  
schwarz/black



30604B  
oliv/OD green



30604R  
coyote tan



30604V  
flecktarn/BW camo



**Kartentasche, „MOLLE“**

2 Innenfächer, Kartentasche 35 x 30 cm transparent und herausnehmbar per Klett, aufgesetztes Frontfach mit 3 Stiftehalter, aufklappbarer Frontdeckel per Klett mit 2 transparenten Kartenfächern, Klettflausch 12 x 10 cm am Deckel  
Material: 100 % Polyester  
Größe/Size: 14 x 17 cm

**Map bag, „MOLLE“**

patch front compartments with 3 pen holders, folding front cover with velcro 2 transparent card compartments, velcro fleece 12 x 10 cm at the cover



30605A  
schwarz/black



30605B  
oliv/OD green



**Modular Tasche**

4 Fächer mit elastischen Kordelbändern  
Material: 100 % Polyester  
Größe/Size: 16 x 15 cm

**Modular pouch**

4 compartments with elastic cord band



30608R  
coyote tan



30608A  
schwarz/black



30608B  
oliv/OD green



**Handytasche, „MOLLE“**

eine unterteilte Mitteltasche mit RV und aufgesetzter Front-Einschubtasche mit Klett, 1 Tasche mit Klett, 1 Tasche mit Clipverschluss, 1 Rückenfach mit Klett, 1 D-Ring  
Material: 100 % Polyester  
Größe/Size: 20 x 14 cm

**Mobile phone bag, „MOLLE“**

subdivided middle pocket with zipper and patch front-thrust in pocket with velcro, 1 pocket with velcro, 1 pocket with clip closure, 1 back pocket with velcro, 1 D-Ring



30609A  
schwarz/black



30609B  
oliv/OD green



30609R  
coyote tan



**Tasche rund, „MOLLE“**

ein großes Hauptfach mit Deckel und RV, eine aufgesetzte Fronttasche mit RV und 2 Klettflauschstreifen, 2 D-Ringe, 1 Karabinerhaken

Material: 100 % Polyester

Größe/Size: 11 x 25 cm

**Bag round, „MOLLE“**

one big main compartment with cover and zipper, one patch front pocket with zipper and 2 velcro fleece stripes, 2 D-Ringe, 1 carabiner



30610R  
coyote tan



30610A  
schwarz/black



30610B  
oliv/OD green



30610Q  
AT-digital



30610T  
woodland



30610V  
flecktarn/BW camo



**Mehrzwecktasche, „MOLLE“, klein**

Reißverschluss oben, aufgesetzte Fronttasche mit Kordelgummiband

Material: 100 % Polyester

Größe/Size: ca. 9 x 10 x 14 cm

**Utility pouch, „MOLLE“, small**

zipper on the top, fitted front pocket with cord elastic band



04613



04563



04593

passende Westen  
auf Seite: 77-79





30611Q  
AT-digital



30611A  
schwarz/black



30611B  
oliv/OD green



30611R  
coyote tan



30611T  
woodland



30611V  
flecktarn/BW camo

**Mehrzwecktasche, „MOLLE“, groß**  
Modular-System, Reißverschluss oben  
Material: 100 % Polyester  
Größe/Size: 24 x 9 x 13 cm  
**Utility pouch, „MOLLE“, big**  
Modular-System, zipper up



30612T  
woodland



30612A  
schwarz/black



30612B  
oliv/OD green



30612Q  
AT-digital



30612R  
coyote tan



30612V  
flecktarn/BW camo



**Funkgerätetasche, „MOLLE“**  
Modular-System, Plastikverschluss mit Kordel  
Material: 100 % Polyester  
Größe/Size: 9 x 5 x 20 cm  
**Radio pouch, „MOLLE“**  
Modular-System, plastic fastener with drawstring



30613R  
coyote tan



30613A  
schwarz/black



30613B  
oliv/OD green



30613Q  
AT-digital



30613T  
woodland



30613V  
flecktarn/BW camo



**Mehrzwecktasche, „MOLLE“, klein**  
Modular-System, mit Reißverschluss  
Material: 100 % Polyester  
Größe/Size: 13 x 7 x 19 cm  
**Utility pouch, „MOLLE“, small**  
Modular-System, with zipper



30614B  
oliv/OD green



30614A  
schwarz/black



30614Q  
AT-digital



30614R  
coyote tan



30614T  
woodland



30614V  
flecktarn/BW camo



**Magazintasche, „MOLLE“, einfach**  
Modular-System, Magazintasche mit Klett  
Material: 100 % Polyester  
Größe/Size: 8,5 x 5 x 16 cm  
**Single mag pouch, „MOLLE“**  
Modular-System, magazine pocket with velcro

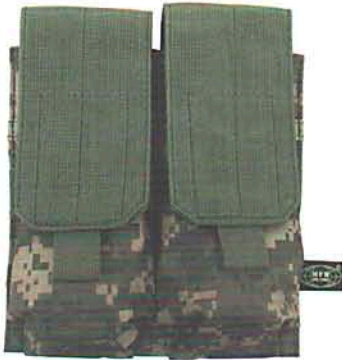

30615Q  
AT-digital



30615A  
schwarz/black



30615B  
oliv/OD green



30615R  
coyote tan



30615T  
woodland



30615V  
flecktarn/BW camo



**Magazintasche, „MOLLE“, doppelt**

Modular-System, 2 Magazintaschen mit Klett

Material: 100 % Polyester

Größe/Size: 8,5 x 5 x 17 cm

**Double mag pouch, „MOLLE“**

Modular-System, 2 magazine pockets with velcro

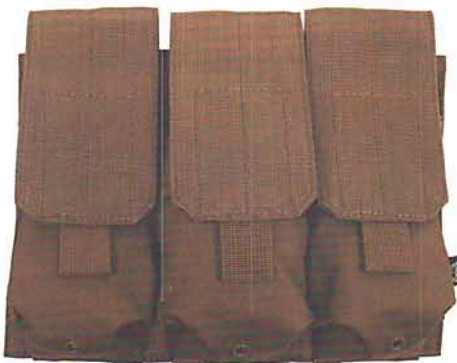

30616R  
coyote tan



30616A  
schwarz/black



30616B  
oliv/OD green

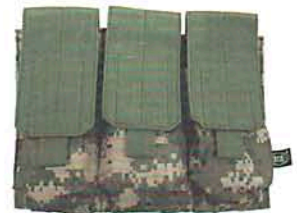

30616Q  
AT-digital



30616T  
woodland



30616V  
flecktarn/BW camo

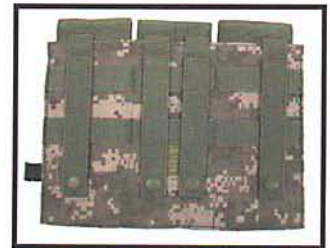

**Magazintasche, „MOLLE“, dreifach**

Modular-System, 3 Magazintaschen mit Klett

Material: 100 % Polyester

Größe/Size: 8,5 x 5 x 17 cm

**Triple mag pouch, „MOLLE“**

Modular-System, 3 magazine pockets with velcro



30617T  
woodland



30617A  
schwarz/black



30617B  
oliv/OD green



30617Q  
AT-digital



30617R  
coyote tan



30617V  
flecktarn/BW camo



**Magazintasche, „MOLLE“, doppelt, klein**

Modular-System, 2 Magazintaschen mit Klett

Material: 100 % Polyester

Größe/Size: 4 x 2 x 12 cm

**Double mag pouch, „MOLLE“, small**

Modular-System, 2 magazines pocket with velcro



04613



04563



04593

passende Westen  
auf Seite: 77-79



**30618A**  
schwarz/black



**30618B**  
oliv/OD green

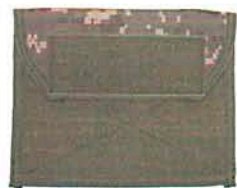

**30618Q**  
AT-digital



**30618R**  
coyote tan



**30618T**  
woodland



**30618V**  
flecktarn/BW camo



**Brusttasche, mit Klett, „MOLLE“**

Modular-System, 2 Innenfächer

Material: 100 % Polyester

Größe/Size: 18 x 14 cm

**Brust pouch, with velcro, „MOLLE“**

Modular-System, 2 inside pockets



**30619T**  
woodland



**30619A**  
schwarz/black



**30619B**  
oliv/OD green



**30619Q**  
AT-digital



**30619R**  
coyote tan



**30619V**  
flecktarn/BW camo



**Patronenhülsen-Tasche, „MOLLE“**

Modular-System, 1 aufgesetzte Fronttasche mit Klett und D-Öse, 2 kleine Seitentaschen, Kordelverschluss oben

Material: 100 % Polyester

Größe/Size: 14 x 8 x 20 cm

**Bullet pouch, „MOLLE“**

Modular-System, 1 patch bellow pocket with velcro, D-eyelet, 2 small side pockets, cord above



**30620B**  
oliv/OD green



**30620A**  
schwarz/black



**30620Q**  
AT-digital



**30620R**  
coyote tan



**30620T**  
woodland



**30620V**  
flecktarn/BW camo



**30620Y**  
BW tropentarn/BW tropical camo



**Trinksystem, „MOLLE“**

mit Trinkbecher, 2,5 Liter, Modular-System, Trinkschlauch mit wechselbarem Mundstück und Abdeckkappe, Schultergurt längenverstellbar, Rückenteil mit Staufach

Material: 100 % Polyester

Größe/Size: 46 x 18 x 2 cm

Gewicht/Weight: ca. 470 g

**Trinking system, „MOLLE“**

with blader, 2,5 liter, Modular-System, drink tube with changeable bite valve and cover cap, shoulder belt adjustable, back part with storage





30695A  
schwarz/black



30695B  
oliv/OD green



30695V  
flecktarn/BW camo



30695R  
coyote tan



**Schulter-Umhängetasche, „MOLLE“**

Modular-System, klein, gefüttertes Hauptfach mit elastischen Haltebändern, abnehmbarer Deckel mit Tragegriff, RV-Fach außen, Klettflausch 12,5 x 10 cm und transparentem Kartenfach 28 x 13 cm innen, abnehmbarer Schulterriemen, längenverstellbar, mit Schulterpolster

Material: 100 % Polyester  
Größe/Size: 28 x 19 x 6,5 cm

**Shoulder bag, „MOLLE“**

Modular-System, small, padded main compartment with elastic holding bands, detachable cover with carrying handle, zipper- compartment outside, velcro patch 12,5 x 10 cm and transparent card compartment 28 x 13 cm inside, detachable shoulder strap, length adjustable, with shoulder padding

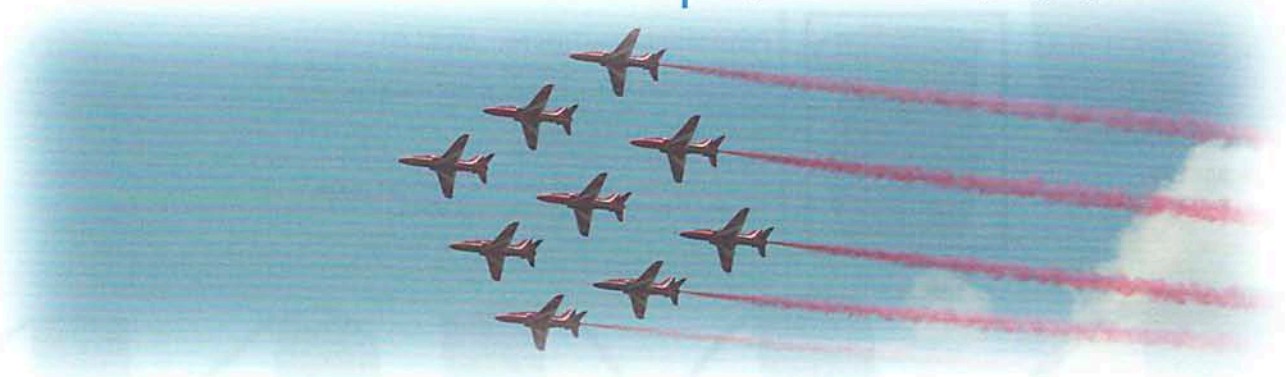

30700R  
coyote tan



30700A  
schwarz/black



30700B  
oliv/OD green

**Schulter-Umhängetasche, „MOLLE“**

Modular-System, großes Hauptfach mit 2 Einschubtaschen innen, 1 aufgesetzte Fronttasche mit Innentasche, Halteband und 1 Karabinerhaken, großes Einschubfach auf Rückseite, Tragegriff, längenverstellbarer und abnehmbarer Schultergurt, 4 D-Ringe, Klettflausch vorne

Material: 100 % Polyester  
**Shoulder bag, „MOLLE“**

Modular-System, big main compartment with 2 thrust in pockets inside, 1 patch front pocket with inner pocket, holder band and 1 carabiner, big thrust in compartment at the back, carrying handle, adjustable length and detachable shoulder belt, 4 D-rings, velcro fleece in the front





30701Q  
AT-digital



30701A  
schwarz/black  
„SECURITY“



30701V  
flecktarn/BW camo



30701R  
coyote tan

**Hip Bag**

Bein- und Gürtelbefestigung, praktische Hüfttasche, ideal für Securitybereich, Freizeit und Reisen, abnehmbarer Hüft- und Oberschenkelgurt, größenverstellbar mit Clipverschluss, 10 verschiedene Fächer, davon 3 mit Reißverschluss und eins abnehmbar, abnehmbares Klettschild  
Material: 100 % Polyester

**Hip Bag**

leg- and belt fixing, handy waist bag, perfect for security work, spare time and traveling, detachable waist and thigh belt, adjustable in width with clip lock, 10 different compartments, 3 of them with zipper and 1 detachable, detachable velcro plate



30702Q  
AT-digital



30702A  
schwarz/black



30702B  
oliv/OD green



30702T  
woodland



30702V  
flecktarn/BW camo



30702Z  
3 Farben desert/3 colour desert

**Schulter-Umhängetasche**

Multi-Schultertasche für Freizeit und Reisen, verstellbarer Schultergurt mit Clipverschluss und Karabiner, 9 verschiedene Fächer, davon 4 mit Reißverschluss  
Material: 100 % Polyester

**Shoulder bag**

multi-shoulder pocket for freetime and traveling, adjustable shoulder strap with clip lock and carabiner, 9 different compartments, 4 of them with zipper



30703Z  
3 Farben desert/3 colour desert



30703A  
schwarz/black



30703B  
oliv/OD green



30703T  
woodland

**Hüft- u. Schultertragetasche**

verstellbarer Gurt mit Clipverschluss oder Gürtelbefestigung, 1 Tragegriff, 7 verschiedene Fächer, davon 4 mit Reißverschluss, 2 Kugelschreiberfächer  
Material: 100 % Polyester

**Hipbag**

waist and shoulder pocket, adjustable strap with clip lock or belt fixing, 1 carrying handle, 7 different compartments, 4 of them with zipper, 2 ballpen pockets



30704A

**Bauchtasche, „Security“**

schwarz, Hüfttasche für Security, Freizeit und Reisen, abnehmbarer Hüft- und Oberschenkelgurt, größenverstellbar mit Clipverschluss, Gürtelbefestigung, 7 verschiedene Fächer, davon 2 mit Reißverschluss, abnehmbares Klettschild für 10 Stifte und ein abnehmbares Klettschild mit SECURITY-Schriftzug

Material: 100 % Polyester

**Fanny pack, „Security“**

black, waist bag for security, spare time and traveling, adjustable waist and thigh belt, adjustable in width with clip lock, belt fixing, 7 different compartments, 2 of them with zippers, detachable velcro plate for 10 pens and one detachable velcro plate with SECURITY writing



30705A

**Gürtel-Umhängetasche**

schwarz, praktische Umhängetasche mit verstellbarem Schulterriemen, Gürtelbefestigung, 6 verschiedene Fächer davon 4 mit Reißverschluss, im Innenfach ein abnehmbares Klettetui

Material: 100 % Polyester

**Shoulderbag**

black, handy shoulder bag with adjustable shoulder strap, belt fixing, 6 different compartments, 4 of them with zippers, inside pocket with detachable velcro case



30706A  
schwarz/black



30706V  
flecktarn/BW camo



30706B  
oliv/OD green

**Schulter-Umhängetasche**

verstellbarer Schultergurt, seitlicher RV zur Größenverstellung des Hauptfachs, 7 verschiedene Fächer davon 2 mit Reißverschluss, 2 Stiftfächer, Kartenfach innen, Taschenverschluss mit Magnetknopf

Material: 100 % Polyester

**Shoulderbag**

adjustable shoulder strap, zipper at the side for adjustable size of the main compartment, 7 different compartments, 2 with zippers, 2 pen compartments, internal card compartment, bag closure with magnet



30707A  
schwarz/black



30707R  
coyote tan

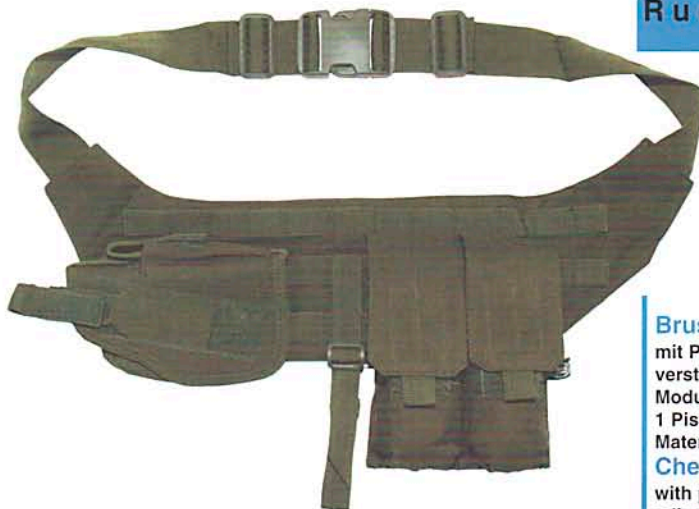

30707B  
oliv/OD green

**Brustgurt**

mit Pistolenholster und Magazintasche, verstellbarer Brustgurt mit Netztasche innen, Modular System, 1 doppelte Magazintasche, 1 Pistolenholster, 1 Gürtelhalter

Material: 100 % Polyester

**Chest strap**

with pistol holder, magazine pouch, adjustable breast belt with net pocket inside, modular system, 1 double magazine pouch, 1 pistol holster, 1 belt holder



30183B  
oliv/OD green



30183A  
schwarz/black



30183T  
woodland

**US Magazintasche**

LC2 (M16), mit 2 Gürtelclips, auch als Gürteltasche verwendbar, 2 Seitenhalterungen

Material: Nylon

Größe/Size: 17 x 11 x 7 cm

**US magazine pouch**

LC2 (M16), with 2 belt clips, usable as belt pocket too, for vacation and work, 2 side holders



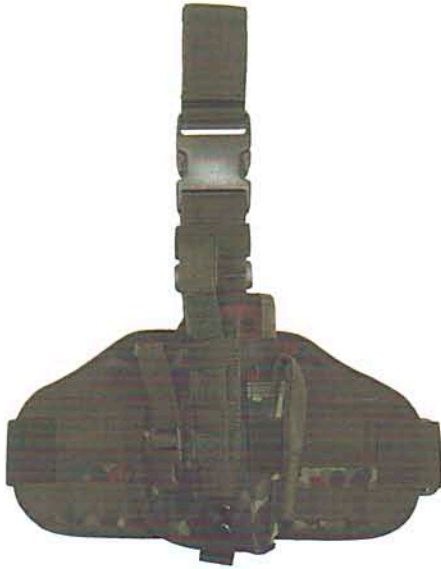

30708V  
flecktarn/BW camo

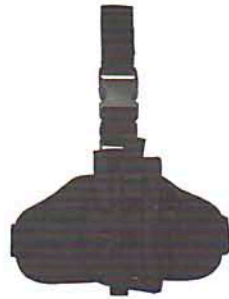

30708A  
schwarz/black



30708B  
oliv/OD green

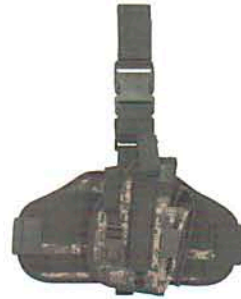

30708Q  
AT-digital

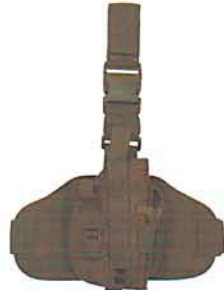

30708R  
coyote tan



30708T  
woodland

**Pistolenbeinholster, „MOLLE“**

Modular-System, Bein- und Gürtelbefestigung, rechts, praktisches Oberschenkelholster mit PVC-Besatz auf der Rückseite, 1 Magazintasche, 1 verstellbarer Beinbefestigungsgurt mit Clipverschluss, höhenverstellbare und abclipbare Gürtelschlaufe

Material: 100 % Polyester

**Tactical holster, „MOLLE“**

Modular-System, leg- and belt fixing, right, practical low ride holster with PVC-trimming at the back, 1 magazine pouch, 1 adjustable leg fixation belt with clip closure, adjustable belt hanger with quick release buckle



30710B  
oliv/OD green



30710A  
schwarz/black



30710R  
coyote tan



30710T  
woodland

**Pistolenbeinholster, rechts**

Modular-System, Bein- und Gürtelbefestigung, Universal-Tiefziehholster für alle gängigen Kurz Waffen, individuelle Größenanpassung per Klett, Waffensicherungsriemen mit Klett/Druckknopf verstellbar, Magazintasche mit Klett, höhenverstellbare und abclipbare Gürtelschlaufe, 2 verstellbare Beingurte

Material: 100 % Polyester

**Tactical holster, right**

Modular-System, leg- and belt fixing, universal low ride holster for all current short weapons, individual size adjustment with velcro, adjustable belt hanger with velcro/press button, magazine pouch with velcro, height adjustable and quick release buckle, 2 adjustable legstraps





30711Q  
AT-digital



30711A  
schwarz/black



30711B  
oliv/OD green



30711T  
woodland



30711V  
flecktarn/BW camo



30711R  
coyote tan

**Pistolenbeinholster, rechts**

Bein- und Gürtelbefestigung, hochwertiges Tiefziehholster für Kurzwaffen, Waffensicherungsriemen mit Klett/Druckknopf verstellbar, 3 Magazintasche mit Clipverschluss, höhenverstellbare und abclipbare Gürtelschlaufe, 2 elastische Beinbänder verstellbar mit Clipverschluss  
Material: 100 % Polyester

**Tactical holster, right**

leg- and belt fixing, high quality holster for short-weapons (adjustable in depth), weapon backup strap (adjustable with velcro and snap), 3 magazine pockets with clip lock, adjustable and detachable belt clew, 2 elastic leg straps adjustable with clip lock

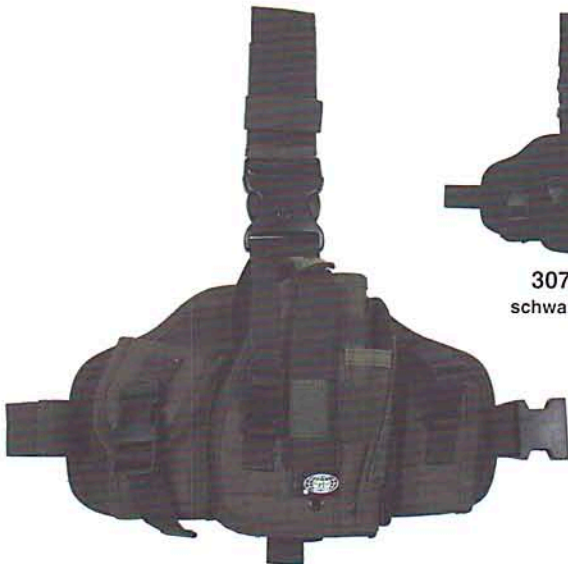

30713B  
oliv/OD green



30713A  
schwarz/black

**Pistolenbeinholster**

Bein- und Gürtelbefestigung, praktisches Oberschenkelholster mit PVC-Besatz auf der Rückseite, 1 Magazintasche, 2 abnehmbare Universaltaschen mit Klett und Druckknopf, 1 verstellbarer Beinbefestigungsgurt mit Clipverschluss, höhenverstellbare und abclipbare Gürtelschlaufe

Material: 100 % Polyester

**Tactical holster**

leg- and belt fixing, handy thigh holster with PVC-trimming on the back, 1 magazine pocket, 2 detachable all-round pockets with velcro and snap, 1 adjustable leg fixing belt with clip lock, height-adjustable and detachable belt loop

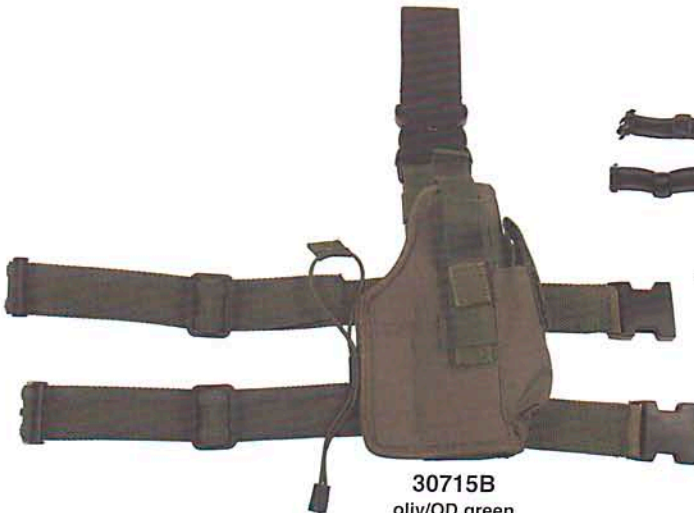

30715B  
oliv/OD green

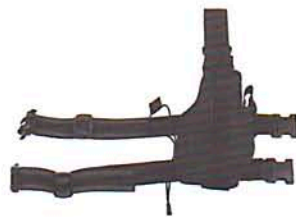

30715A  
schwarz/black



30715Q  
AT-digital

**Pistolenbeinholster, „NATO“**

rutschfest, Bein- und Gürtelbefestigung, Tiefziehholster für alle gängigen Kurzwaffen, Waffensicherungsriemen mit Klett/Druckknopf verstellbar, Magazintasche mit Klett, höhenverstellbare und abclipbare Gürtelschlaufe, 2 verstellbare Beinbänder mit Antirutschgummi  
Material: 100 % Polyester

**Tactical holster, „NATO“**

non-slip, leg- and belt fixing, low ride holster for all usual handguns, tactical thumb snap with velcro/press button adjustable, magazine pouch with velcro, height adjustable and detachable holster



30725T  
woodland



30725A  
schwarz/black



30725B  
oliv/OD green



30725I  
CCE tarn/CCE camo



30725J  
CZ tarn/CZ camo



30725N  
snowcamo



30725O  
BW wintertarn/BW winter camo



30725Q  
AT-digital

**Pistolenbeinholster, rechts**

Bein- und Gürtelbefestigung, Tiefziehholster für alle gängigen Kurzwaffen, Waffensicherungsriemen mit Klett/Druckknopf verstellbar, Magazintasche mit Klett, höhenverstellbare und abclippbare Gürtelschlaufe, 2 elastische Beingurte verstellbar  
Material: 100 % Polyester

**Tactical holster, right**

leg- and belt fixing, heighth-adjustable for all popular short weapons, weapon backup strap with velcro and snap, adjustable, magazine pocket with velcro, heighth-adjustable and detachable belt clew, 2 adjustable elastic leg belts

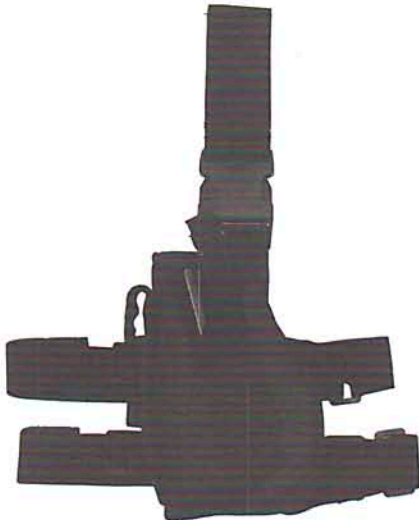

30726A  
schwarz/black



30726B  
oliv/OD green



30726T  
woodland

**Pistolenbeinholster, links**

Bein- und Gürtelbefestigung, Tiefziehholster für alle gängigen Kurzwaffen, Waffensicherungsriemen mit Klett/Druckknopf verstellbar, Magazintasche mit Klett, höhenverstellbare und abclippbare Gürtelschlaufe, 2 elastische Beingurte verstellbar  
Material: 100 % Polyester

**Tactical holster, left**

leg- and belt fixing, heighth-adjustable for all popular short weapons, weapon backup strap with velcro and snap, adjustable, magazine pocket with velcro, heighth-adjustable and detachable belt clew, 2 adjustable elastic leg belts



30727T  
woodland



30727A  
schwarz/black



30727B  
oliv/OD green



30727I  
CCE tarn/CCE camo

**Pistolenschulterholster, rechts**

mit Magazintasche, verstellbare Riemen  
Material: 100 % Polyester

**Pistol shoulder holster, right**

with magazine pockets, adjustable straps





30728A  
schwarz/black



30728B  
oliv/OD green



30728T  
woodland

**Pistolenschulterholster, links**  
mit Magazintasche, verstellbare Riemen  
Material: 100 % Polyester  
**Pistol shoulder holster, left**  
with magazine pockets, adjustable straps



30743T  
woodland



30743A  
schwarz/black



30743B  
oliv/OD green



30743Q  
AT-digital

**Magazintasche Beinhalterung**  
für zwei Magazine, taktische Oberschenkelmagazintasche,  
1 Gürtelbefestigung und 2 Beinurte verstellbar und abnehmbar,  
2 Magazintaschen in der Größe: 8,5 x 2,5 x 17 cm, mit Klett  
Material: 100 % Nylon  
**Tactical leg pouch**  
tactical thigh magazine pocket, 1 belt fixing and 2 leg belts (detachable  
and adjustable), 2 magazine pockets with the size of 8,5 x 2,5 x 17 cm,  
with velcro







**30675V**  
**BW Spatentasche**  
 für Trageausrüstung, mit BW Adapterplatte, flecktarn, Mod.  
**BW shovel cover**  
 BW camo, with BW adapter plate

**30722**  
**Österr. Pistolenholster**  
 schwarz, mit Kunststoffschale,  
 für Browning HP, Beretta 92, Sig Sauer P226  
**Austrian holster**  
 black, with plastic cover,  
 use for Browning HP, Beretta 92, Sig Sauer P226



**30723**  
**Pistolenholster, P1**  
 schwarz, mit Sicherheitsbügel  
**Holster, P1**  
 black, with safety catch



**30753B**  
 oliv/OD green



**30753A**  
 schwarz/black

**Sicherheitsband, für Pistole**  
 mit Karabiner  
 Material: 100 % Polyester  
**Security spring strap for gun**  
 with carabiner



**30451B**  
**Expander**  
 oliv, mit Haken, Länge: 90 cm  
**Expander**  
 OD green, with hook, length: 90 cm



**30757A**  
 schwarz/black

**Bungee-Gewehrgurt**  
 Befestigung mit Karabiner,  
 abnehmbarer Karabiner per Clip,  
 elastisches Element,  
 längenverstellbar: 55 bis 75 cm (ungedehnt)  
 Material: 100 % Polyester



**30757B**  
 oliv/OD green

**Bungee-sling**  
 carabiner detachable per clip,  
 elastic element,  
 adjustable length: 55 to 75 cm (undilated)



**30757R**  
 coyote tan



**30432**  
**Beckengurt für Rucksack**  
 mit Riemenpolsterung, schwarz  
**Waist belt for backpack**  
 with strap padding, black

**Überzug für Rucksack**  
 groß, für Rucksäcke bis 65 Ltr.  
 Material: 100 % Nylon  
**BW backpack cover**  
 large, for backpacks up to 65 l



**30803V**  
 flecktarn/BW camo



**30803Y**  
 BW tropentarn/BW tropical camo





30773B  
oliv/OD green

**Gewehrfutteral**

gefüttert, universal Gewehrtaische mit abnehmbarem Schulterriemen, gefütterter Tragegriff, Schnellverschluss an der Vorderseite, Längsöffnung mit stabilem Reißverschluss, 1 aufgesetzte Magazintasche mit Reißverschluss außen, Gesamtlänge: 130 cm  
Material: 100 % Nylon

**Rifle cover**

lined, allround rifle bag with detachable shoulder straps, lined carrying handle, quick lock on the front side, longitudinal split with solid zipper, 1 external magazine pocket with zipper outside, total length: 130 cm



30773A  
schwarz/black



30783T  
woodland



30783A  
schwarz/black

**Gewehrfutteral, „Paintball“**

gefüttert, universal Gewehrtaische mit abnehmbarem Schulterriemen, Tragegriffe, abnehm- und verstellbare Schultergurte, verstellbarer Beckengurt, 3 aufgesetzte Außentaschen mit Klett, 1 Außentache mit Reißverschluss, Gesamtlänge: 123 cm  
Material: 100 % Nylon

**Rifle cover, „Paintball“**

lined, allround rifle bag with detachable shoulder straps, carrying handles, detachable and adjustable shoulder belts, adjustable pelvic belt, 3 external pockets with velcro, 1 external pocket with zipper, total length: 123 cm



30661

**Tasche, „Security“**

schwarz, Einsatztasche mit diversen Haltern und Fächern (ohne Deko!)

Material: 100 % Polyester

**Bag, "SECURITY"**

black, mission bag with various holders and compartments





30813

**Rucksack, „Fox Haidel 30“**

schwarz-sand, gepolsterte, verstellbare Schultergurte, 2 Seitentaschen, 1 innere Ballontasche, 1 Deckeltasche, 2 Kompressionsgurte, Tragegriff, ca. 30 Liter Fassungsvermögen

Material: 100 % Polyester

**Rucksack, „Fox Haidel 30“**

black-sand, padded, adjustable shoulder belts, 2 side pockets, 1 ballon bag, 1 covered pocket, 2 compression belts, carrying handle, about 30 ltr capacity



30833

**Rucksack, „Fox Haidel 70“**

schwarz-sand, mit aufwendiger Rückenpolsterung für guten Tragekomfort, gepolsterte, verstellbare Schultergurte und Hüftgurt, Tragegriff, 2 seitliche Staunetze, 2 Seitentaschen, 1 Deckeltasche außen, 1 Deckeltasche innen, 2 Kompressionsgurte, 1 Platte als Rückenverstärkung und 2 Aluschienen, Verschluss mit Zugband oder Plastikverschlüsse möglich, ca. 70 Liter Fassungsvermögen

Material: 100 % Polyester

**Rucksack, „Fox Haidel 70“**

black-sand, with elaborate back padding for high wearing comfort, padded and adjustable shoulder and waistbelts, carrying handle, 2 side mesh pockets, 2 side pockets, 1 outside lidbag, 1 covered bag inside, 2 compression belts, 1 sheet for back-reinforcement and 2 aluminium bars, locking possible with strap or plastic locks, about 70 ltr capacity

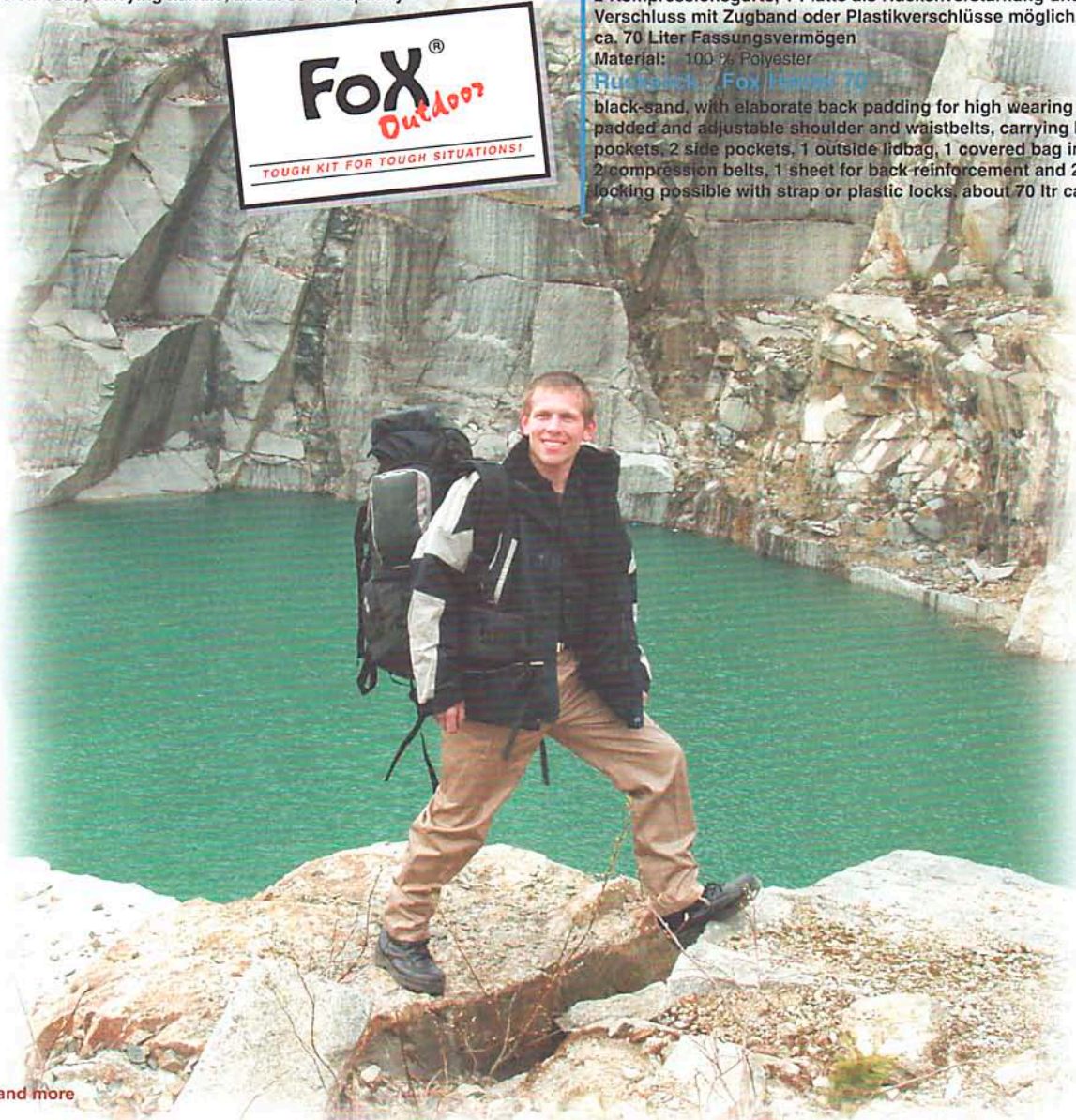



30861

**Rucksack, „Fox Air 40“**

rot-schwarz-grau, komfortabler Wanderrucksack mit aufwändiger Rückenpolsterung und Aircomfort-Belüftungssystem, Tragegriff, gepolsterte, verstellbare Schulter- u. Hüftgurte, 2 eingearbeitete Aluschienen im Rückenbereich, Schmutzwäschefach am Boden mit RV, 2 Seitentaschen mit RV, 1 Deckeltasche außen mit RV, 1 seitliche Öffnung mit RV zum Hauptfach, Regenüberzug, Fassungsvermögen ca. 40 Liter

Material: 100 % Nylon

Größe/Size: 60 x 30 x 23 cm

**Rucksack, „Fox Air 40“**

red-black-grey, comfortable rucksack with back padding and comfort ventilation system, padded carrying handle, adjustable shoulder belts and hip belt, 2 aluminium rails in the lower back part, zipped compartment for laundry at the bottom, 2 zipped side pockets, 1 exterior top lid, zipped, 1 side opening with zip for main compartment, rain cover, about 40 ltr capacity



30862

**Rucksack, „Fox Air 60“**

rot-schwarz-grau, komfortabler Wanderrucksack mit aufwändiger Rückenpolsterung und Aircomfort-Belüftungssystem, Tragegriff, gepolsterte, verstellbare Schulter- u. Hüftgurte, 2 eingearbeitete Aluschienen im Rückenbereich, Schmutzwäschefach am Boden mit RV, 2 Seitentaschen mit RV, 1 Deckeltasche außen mit RV, 1 seitliche Öffnung mit RV zum Hauptfach, Regenüberzug, Fassungsvermögen ca. 60 Liter

Material: 100 % Nylon

Größe/Size: 80 x 35 x 28 cm

**Rucksack, „Fox Air 60“**

red-black-grey, comfortable rucksack with back padding and comfort ventilation system, padded carrying handle, adjustable shoulder belts and hip belts, 2 aluminium rails in the lower back part, zipped compartment for laundry at the bottom, 2 zipped side pockets, 1 exterior top lid, zipped, 1 side opening with zip for main compartment, rain cover, about 60 ltr capacity

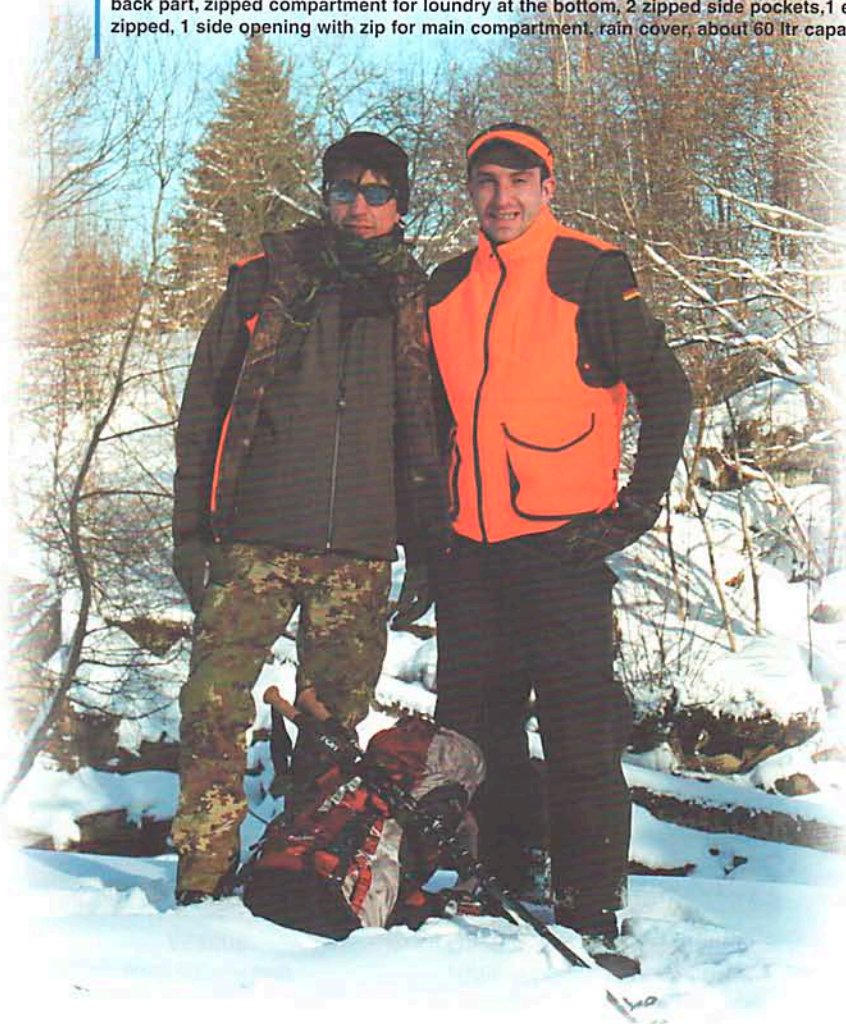



30963V

**Terminplaner**

flecktarn, Delux, Cordura, 1 Stiffach, 8 Einsteckfächer, DIN A-5 Ringbuchhalterung  
Material: 100 % Polyamid (Cordura)

**Schedule**

BW camo, Cordura, 1 pencil opening, 8 internal compartments, DIN A-5 ring binder attachment



30982V

**Schreibmappe**

flecktarn, Cordura, A5, 1 Stiffach, 1 Netzteilfach mit RV, 5 Einsteckfächer innen, 1 Einsteckfach für einen Schreibblock innen, Außenseite mit Klettband für Namensschild  
Material: 100 % Polyamid (Cordura)

**Writing briefcase**

BW camo, Cordura, A5, 1 pencil opening, 1 mesh compartment with zipper, 5 interior pockets, 1 interior pocket for writing pad, external side with velcro for label

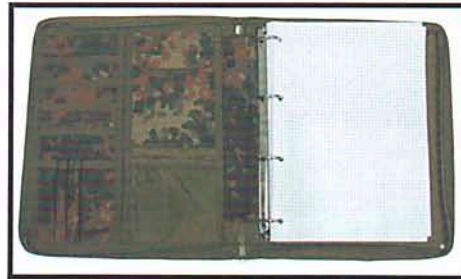

30984V

**Schreibmappe**

Flecktarnbezug, A4, Register, Blätter, Kartenfach, 3 Stiffächer, 1 Netzteilfach, 1 Innentasche mit Klettverschluss, 7 Einsteckfächer innen, Außenseite mit Klettband für Namensschild  
Material: 100 % Polyester 600 D

**Writing case**

BW camo, A4, 3 pen pockets, 1 mesh pocket, 1 inside pocket with velcro, 7 pouch pockets inside, external side with velcro for label



**Schreibmappe**

A4, 3 Stiffächer, 7 Einsteckfächer, 1 Innentasche mit Verschlussklappe und Klett, 2 Kartenfächer, 1 Ringbrett für Papier, 1 aufgesetzte Netztasche mit Reißverschluss und ein Klettband für Namensschild auf der Außenhülle  
Material: 100 % Polyester 600 D

**Writing case**

A4, 3 pencil case, 7 push-in case, 1 insidepocket with slide flap and velcro, 2 card pocket, 1 mesh pocket with zip, external side with velcro for label



30985B  
oliv/OD green



30985Q  
AT-digital



30985V  
flecktarn/BW camo



30986R  
coyote tan



30986A  
schwarz/black



30986V  
flecktarn/BW camo

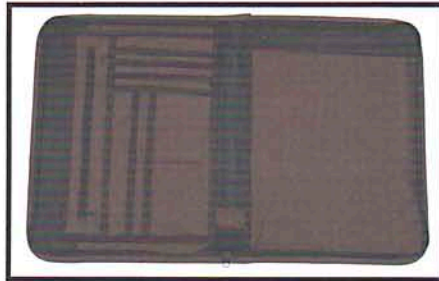

**Schreibmappe**

A4, Deluxe, 2 Stiftfächer, 9 Einsteckfächer,  
1 Innenfach mit Reißverschluss,  
2 Kartenfächer innen, 1 Kartenfach außen  
Material: 100 % Polyester 600 D

**Writing case**

A4, deluxe, 2 pencil cases, 9 push-in cases,  
1 inside pocket with zip, 2 card pockets inside,  
1 card pocket outside



30943B  
oliv/OD green

**Hüfttasche, mit Trinkflasche**

verstellbarer Hüftgurt mit 2 kleinen RV-Taschen,  
2 Taschen mit RV, 1 Netzfach für Trinkflasche, Tragegriff  
Material: 100 % Polyester

**Waist bag, with drink-bottle**

adjustable belt with 2 small zipped pockets,  
2 pockets with zipper, 1 mesh compartment for  
drink bottle, carrying handle



30943A  
schwarz/black



30943T  
woodland



30943J  
CZ tarn/CZ camo



30973B  
oliv/OD green



30973A  
schwarz/black



**Gürteltasche, mit Handytasche**

praktische Bauchgürteltasche mit verstellbarem Gurt-  
und Clipverschluss, 2 aufgesetzte Taschen mit Reißver-  
schluss, 1 kleine Tasche mit Klettverschluss  
Material: 100 % Polyester

**Waist bag, with cellphone pocket**

with adjustable belt and clip lock, 2 external pockets with  
zipper, 1 small pocket with velcro



30990R  
coyote tan



30990A  
schwarz/black



30990B  
oliv/OD green



**Weste, Rucksack und Taschen in einem**

als Weste, Rucksack oder Tasche verwendbar, größenverstellbar, 5 große Außentaschen, 4 davon mit RV und 1 mit Klett, 1 Netzinnetasche an vorderen Klappe, 2 kleine Seitentaschen mit Klett, Netzinnetfutter

Material: 100 % Polyester

**Vest, bagpack and bag in one**

usable as vest, rucksack or bag, adjustable size, 5 big external pockets, 4 of with zipper, 1 with velcro, 1 at the front cover, 2 small side pockets with velcro, mesh internal lining



30930R  
coyote tan



30930A  
schwarz/black



30930B  
oliv/OD green



**Brustbeutel**

aufklappbar, 2 Innentaschen mit Reißverschluss, 8 Steckfächer für Ausweis-Papiere, Führerschein usw. innen, 2 Fensterfächer an Front, versenkbarer Umhängegurt mit Kordelstopper

Material: 100 % Polyester

Größe/Size: 15 x 12,5 cm geschlossen/closed  
37 x 12,5 cm offen/open

**ID case**

folding, 2 inner pockets with zip, 8 compartments for identity cards, driving licence inside, 2 window pockets in the front, lowerable shoulder strap with cord stopper

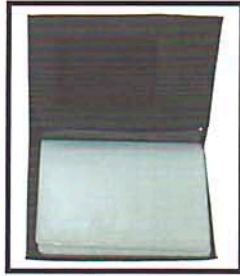

**30903V**

**Ausweishülle**

flecktarn, Cordura, 5 Steckfächer, 12 Sichthüllen

Material: 100 % Polyamid (Cordura)

Größe/Size: 12 x 8 cm

**Licence holder**

BW camo, Cordura, 5 internal compartments, 12 clear plastic pockets



**30913V**

**Nylongeldbörse**

flecktarn, Cordura

Material: 100 % Polyamid (Cordura)

**Wallet**

BW camo, Cordura



**30926A**

Marine



**30923V**

flecktarn/BW camo



**30927A**

Eurocorps



**30926L**

Sanitär



**30926W**

Luftwaffe



**30923Y**

BW tropentarn/BW tropical camo



**30927B**

1.NL/D-Corps



**30927C**

D/F-Brigade

**Nylongeldbörse**

blau, mit Klettverschluss und Ausweifenster

**Nylon Wallet**

blue, with velcro and licence window

**Nylongeldbörse**

mit Klettverschluss

**Nylon Wallet**

with velcro

**Nylongeldbörse**

flecktarn, mit Klettverschluss und Ausweifenster

**Nylon Wallet**

BW camo, with velcro and licence window

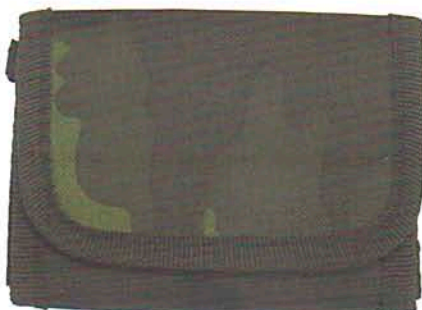

**30929J**

**Nylongeldbörse**

CZ tarn, mit Klettverschluss

**Wallet**

CZ camo, with velcro







Nylongeldbörse

flecktarn, mit Klettverschluss und Ausweisfenster

Nylon Wallet

BW camo, with velcro and licence window



Motive:



30925A PSV



30925B Fernmelder



30925C Artillerie



30925D Heeresflugabw.



30925E Feldjäger



30925F Instandsetzung



30925G Nachschub



30925H Pioniere



30925I Topographie



30925J ABC-Abwehr



30925K Musikkorps



30925L Sanitäter



30925M Jäger



30925N Wachbattalion



30925O Panzergrenadier



30925P Fallschirmjäger



30925Q Fernspäher



30925R Heeresflieger



30925S Panzeraufklärer

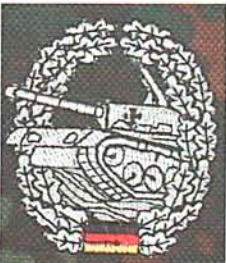

30925T Panzer



30925U Marinesicherung



30925V Panzerjäger



30925W Luftwaffe



30925X Edelweiß



30925Y KSK



30925Z LW Sicherungstruppe





31175

**GI Modular Schlafsack System, Außenteil**

„Petrol“, grün, neues Schlafsack System der US Army,  
Temperaturbereich bis -1° C,  
(in Verbindung mit Art.Nr. 31185 bis -46° C)

Aussenmaterial/Outer shell: 100 % Nylon Rip Stop  
Füllung/Filling: 100 % Polyester  
Innenmaterial/Lining: 100 % Nylon Rip Stop  
Reißverschluss/Zipper: YKK Nylon  
Größe/Size: 210 cm Länge/Length, 88 cm Breite oben/Width up  
Gewicht/Weight: 1050 Gramm

**GI modular sleep system, outside**

„Petrol“ green, new sleeping bag system from US Army,  
temperature range to -1° C,  
(in connection with item no. 31185 to -46° C)

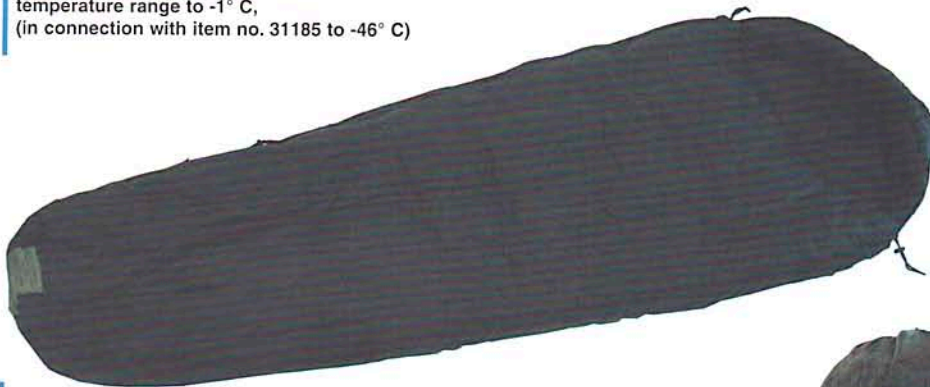

31185

**GI Modular Schlafsack System, Innenteil**

„Intermediate Cold Weather“, schwarz,  
neues Schlafsack System der US Army,  
Temperaturbereich bis -23° C,  
(in Verbindung mit Art.Nr. 31175 bis -46° C)

Aussenmaterial/Outer shell: 100 % Nylon Rip Stop  
Füllung/Filling: 100 % Polyester  
Innenmaterial/Lining: 100 % Nylon Rip Stop  
Reißverschluss/Zipper: YKK Nylon  
Größe/Size: 210 cm Länge/Length, 88 cm Breite oben/Width up  
Gewicht/Weight: 1700 Gramm

**GI modular sleep system, inside**

„Intermediate Cold Weather“, black,  
new sleeping bag system from US Army,  
temperature range to -23° C,  
(in connection with item no. 31175 to -46° C)



31425

**US Kompressionsack**

schwarz, für Schlafsack  
Größe/Size: 70 x 31 cm  
**US Stuff sack**  
black, for sleeping bag



31412B

**BW Kompressionsack**

oliv, für Schlafsack, Mod.  
**Stuff sack**  
OD green, for sleeping bag



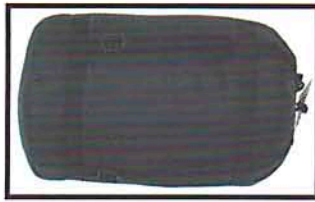

31622A  
schwarz/black



31622G  
blau/blue



31622B  
oliv/OD green



31622T  
woodland



31622V  
flecktarn/BW camo



**Mumienschlafsack**

2-lagig, mit Kopfteil  
 Aussenmaterial/Outer shell: 100 % Polyester  
 Innenmaterial/Lining: 100 % Baumwolle/Cotton  
 Füllung/Filling: 2 x 225 g/m<sup>2</sup> Hollow Fiber/Polyester  
 Größe/Size: 220 x 50 x 75 cm  
 Packmaß/Packsize: 40 x 25 cm  
 Gewicht/Weight: 1950 Gramm

**Sleeping bag**

2-ply, with head section





31642B  
oliv/OD green

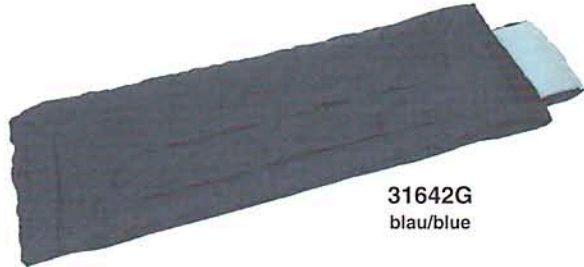
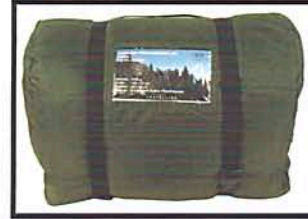

31642G  
blau/blue



31642T  
woodland

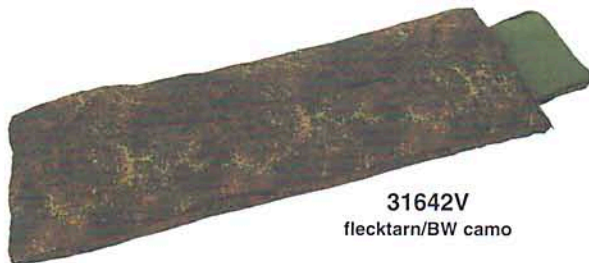

31642V  
flecktarn/BW camo

**Israelischer Pilotenschlafsack**

kältezonenfremd, koppelbar mit 2. Schlafsack

- Außenmaterial/Outer shell: 100 % Polyester
- Innenmaterial/Lining: 100 % Baumwolle/Cotton
- Füllung/Filling: 2 x 200 g/m<sup>2</sup> Hollow Fiber/Polyester
- Größe/Size: 190 x 75 cm, Kopfteil/Headsection: 30 x 40 cm
- Packmaß/Packsize: 40 x 25 cm
- Gewicht/Weight: 1800 Gramm

**Israeli pilot sleeping bag**

cold region free, attachable with 2nd sleeping bag

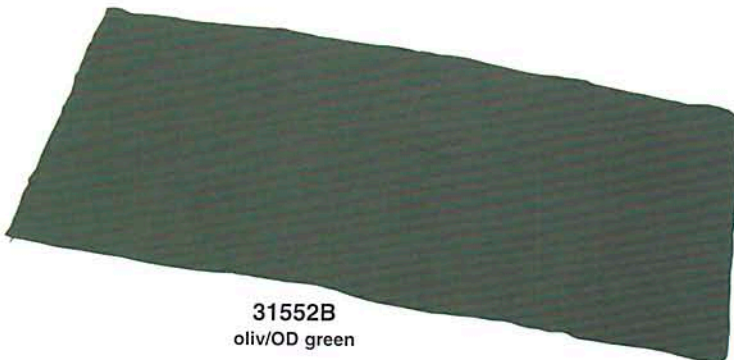

31552B  
oliv/OD green



31552A  
schwarz/black



**Schlafsack, „Fleece“**

praktischer Deckenschlafsack ohne Kopfteil, umlaufender Reißverschluss, als Schlafsack oder Decke verwendbar

- Material: 100 % Polyesterfleece
- Größe/Size: 190 x 75 cm
- Packmaß/Packsize: 38 x 15 cm
- Gewicht/Weight: 700 Gramm

**Sleeping bag, „Fleece“**

effectively cover sleeping bag, without head section, circulating zipper, usable as sleeping bag or cover

31875

## Camping-Tisch

ALU-poliert, klappbar, super leicht, extra groß,  
in Nylon-Tragetasche

Größe/Size: 70 x 70 x 120 cm

Packmaß/Pack Size: 15 x 17 x 72 cm

## Camping table

alu polish, foldable, light, extra big,  
in nylon carry bag



31874

## Camping-Tisch

ALU-poliert, klappbar, super leicht,  
in Nylon-Tragetasche

Größe/Size: 70 x 70 x 70 cm

Packmaß/Pack Size: 12 x 12 x 72 cm

## Camping table

alu polish, foldable, light,  
in nylon carry bag



31881B  
oliv/OD green

## Klappstuhl, De Lux

mit Rücken- u. Armlehne, Flaschenhalter und Transportsack,  
höhenverstellbares Kopfpolster

Material: Nylon, Metall

Packmaß/Pack Size: 18 x 14 x 100 cm

## Folding chair, de lux

with back- and armrest, bottle holder, carrying bag,  
height-adjustable head padding



31881F  
khaki





31885B

**Hängestuhl**

Dreibeingestell, oliv

Größe/Size:

Packmaß/Pack Size: 100 x 15 x 15 cm

Material:

**Hanging chair**

tripod rack, OD green

Höhe/Height: 2,10 m, Breite/Width: 1,80 m

Nylon, Metall



31781B

**Thermokissen**

oliv, selbstaufblasbar

Größe/Size:

42 x 31 x 3 cm

Packmaß/Pack Size:

32 x 8 cm

**Thermal pad**

OD green, self-inflating



31896

**Klapphocker, Dreibein**

oliv, Transporttasche mit Trageriemen, hohe Standfestigkeit durch große Fußsteller, Sitzhöhe ca. 40 cm

Material: Nylon, Metall

**Folding chair, tripod**

OD green, carrying bag with strap, high stability due to large base plate, seat height about 40 cm

31897

**Klapphocker, Teleskop-Dreibein**

oliv, höhenverstellbar, Transporttasche mit Trageriemen, hohe Standfestigkeit durch große Fußsteller,

Sitzhöhe verstellbar ca. 45 bis 55 cm

Material: Nylon, Metall

**Folding chair, 3-leg telescope**

OD green, carrying bag with strap, high stability through big footplate, sitting height adjustable until 45 to 55 cm



31773B

**Thermomatte**

oliv, selbstaufblasbar, mit Nylon-Tragesack

Größe/Size: 188 x 75 x 3 cm

**Thermal mat**

OD green, self-inflating, with nylon carrying bag



**31385**

**BW Isomatte**

oliv, kleines Format, Mod., aufklappbar  
Größe/Size: 190 x 56 x 0,4 cm

**BW sleeping pad**

OD green, small format, foldable

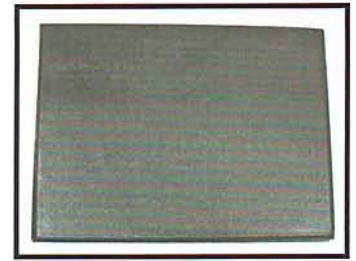
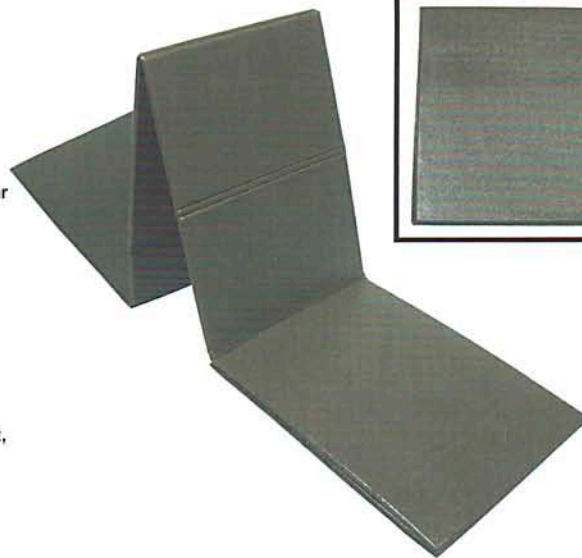

**31342**

**Iso Matte**

grün, 10 mm, alubeschichtet,  
mit verstellbaren Riemen  
Größe/Size: 50 x 200 cm

**Sleeping pad**

green, 10 mm, aluminized,  
with adjustable straps



**31333B**

**US Iso Matte**

grün, 12 mm,  
mit verstellbaren Riemen  
Größe/Size: 70 x 180 cm

**US sleeping pad**

green, 12 mm,  
with adjustable straps



**31825B**

**Hängematte, „Jungle“**

oliv, mit Dach und Moskitonetz  
Größe/Size: 220 x 75 x 55 cm

**Army hammock, „Jungle“**

OD green, with mosquito net

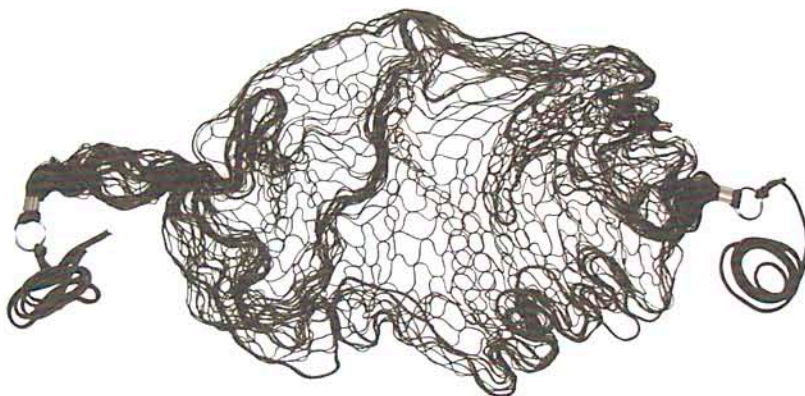

**31791B**

**Hängematte**

klein, oliv

Material: 100 % Polyamid

Größe/Size: 185 x 52 x 2 cm

**Hammock**

mini, OD green

**31795B**

**Hängematte**

Canvas, oliv

Material: 100 % Baumwolle/Cotton

Größe/Size: 200 x 100 cm

**Hammock**

canvas, OD green





**31833B**  
oliv/OD green

**Moskitonetz, für Bett**

verpackt in Nylonbeutel

Größe/Size: 0,63 m Umfang oben/Extent up  
2,00 m Höhe/Height  
8,00 m Umfang unten/Extent down

**Mosquito net, single**

packaged in nylon bag



**31833L**  
weiß/white

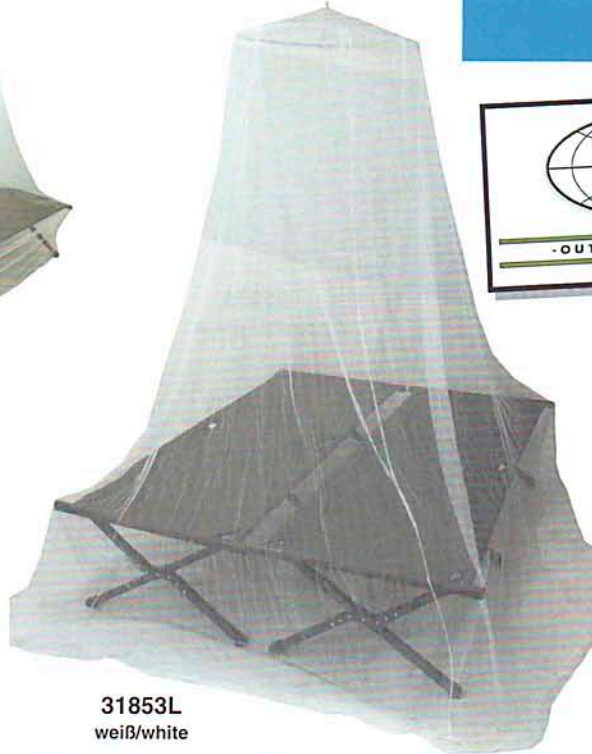

**31853L**  
weiß/white



**31853B**  
oliv/OD green



in Nylonbeutel!

**Moskitonetz, für Doppelbett**

verpackt in Nylonbeutel

Größe/Size: 0,63 m Umfang oben/Extent up  
2,50 m Höhe/Height  
12,50 m Umfang unten/Extent down

**Mosquito net, double**

packaged in nylon bag



**31865B**  
oliv/OD green



**31865L**  
weiß/white

**Camping Moskitonetz**

Zeltform

Material: 100 % Baumwolle/Cotton

Größe/Size: 200 x 150 x 100 cm

**Mosquito net, camping**

tent-shaped







31933  
oliv/OD green

**US-Feldbett**

Nylonbezug, verstärktes Alu-Gestell,  
in Nylon-Tragetasche

Größe/Size: 190 x 66 x 42 cm  
Packmaß/Pack Size: 95 x 18 x 11 cm

**US cot**

nylon cover, reinforced aluminium framework,  
in nylon carrying bag



31934  
schwarz/black



31936  
flecktarn/BW camo



31935  
woodland

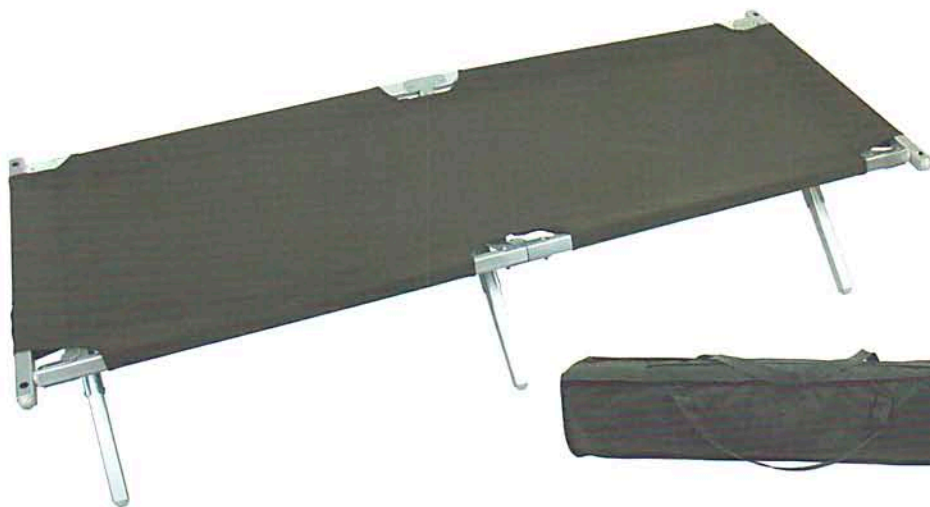

**31904**

**US-Feldbett**

Alu, oliv, wie original, Tragetasche,  
32 x 32 mm Alu Rohr,  
Nylonbezug 420D Oxford  
Größe/Size: 197 x 69 x 43 cm

**US cot**

alu, OD green, in nylon carrying bag,  
32 x 32 mm aluminium bar,  
nylon cover 420D Oxford



**31951**

**US-Feldbett**

Alu, oliv, extra lang, Tragetasche,  
Rahmen: Aluminium 25x25, 25x30 mm,  
Bespannung: 600D Polyester, PVC beschichtet  
Größe/Size: 200 x 65 x 40 cm

**US cot**

alu, OD green, long, carrying bag,  
framework: aluminium 25x25, 25x30 mm,  
covering: 600D polyester, PVC coated



**32103V**  
flecktarn/BW camo



**32103T**  
woodland

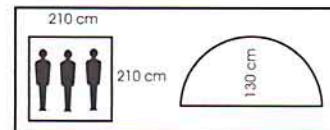

**32103Y**  
BW tropentarn/BW tropical camo



**Zelt, „Monodom“**

stabiles und leichtes 3 Personen-Zelt, mit Moskitonetzeingang und Tragetasche, Außenmaterial: 190 T Nylon PU beschichtet, einwandig, Boden: trittfestes PU-Gewebe, Gestänge: Glasfieber, Heringe: Stahl  
 Größe/Size: 210 x 210 x 130 cm  
 Packmaß/Pack Size: 65 x 12 x 12 cm  
 Gewicht/Weight: 2550 g

**Tent, „Monodom“**

solid and light tent for 3 persons, with mosquito net entrance and carrying bag, outer shell: 190 T Nylon PU coated, 1-ply, floor: non-slip PU material, framework: fibreglass, tent pegs: steel



**32123T**  
woodland

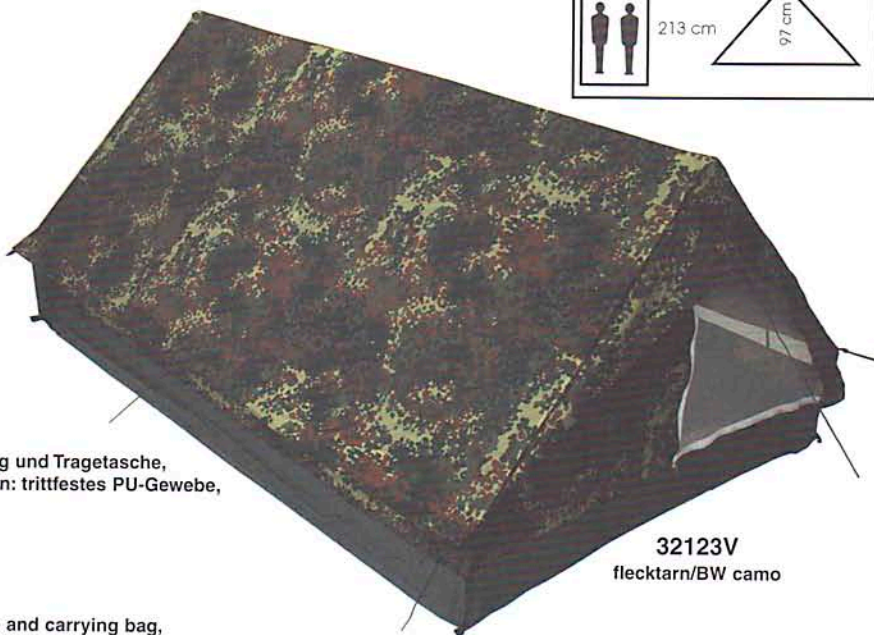

**32123V**  
flecktarn/BW camo

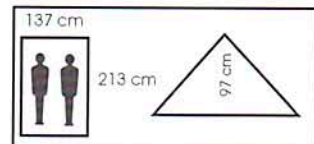

**Zelt, „Minipack“**

stabiles und leichtes 2 Personen-Zelt, mit Moskitonetzeingang und Tragetasche, Außenmaterial: 190 T Nylon PU beschichtet, einwandig, Boden: trittfestes PU-Gewebe, Gestänge: Metall, Heringe: Stahl  
 Größe/Size: 213 x 137 x 97 cm  
 Packmaß/Pack Size: 55 x 12 x 12 cm  
 Gewicht/Weight: 1850 g

**Tent, „Minipack“**

solid and light tent for 2 persons, with mosquito net entrance and carrying bag, outer shell: 190 T Nylon PU coated, 1-ply, floor: non-slip PU material, framework: metal, tent pegs: steel



**32133B**

**Indianer Zelt, „Tipi“**

oliv, stabiles 3 Personen-Zelt mit Mittelmast, mit Moskitonetzeingang und Tragetasche, Außenmaterial: 190 T Nylon PU beschichtet, einwandig, Boden: trittfestes PU-Gewebe, wasserdicht, Gestänge: 22 mm Metall, Heringe: Stahl, Wassersäule: 1200 mm  
 Größe/Size: 290 x 270 x 225 cm  
 Packmaß/Pack Size: 62 x 15,5 x 15,5 cm  
 Gewicht/Weight: 3800 g

**Indian tent, „Tipi“**

OD green, solid tent for 3 persons, with mosquito net entrance and carrying bag, outer shell: 190 T Nylon PU coated, 1-ply, floor: non-slip PU material, waterproof, framework: 22 mm metal, tent pegs: steel, water column: 1200 mm

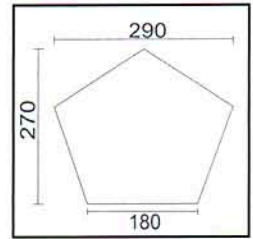

**32143V**  
flecktarn/BW camo



**32143B**  
oliv/OD green

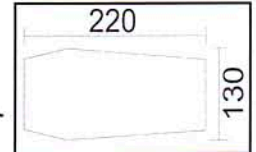

**Tunnelzelt, „Hochstein“**

stabiles 2 Personen-Zelt, mit Moskitonetzeingang und Tragetasche, Außenmaterial: 190 T Nylon PU beschichtet, einwandig, Boden: trittfestes PU-Gewebe, wasserdicht, Gestänge: 6,9 mm Fiberglas, Heringe: Stahl, Wassersäule: 1200 mm  
 Größe/Size: 220 x 130 x 100 cm  
 Packmaß/Pack Size: 58 x 11 x 11 cm  
 Gewicht/Weight: 1600 g

**Tunnel tent, „Hochstein“**

solid tent for 2 persons, with mosquito net entrance and carrying bag, outer shell: 190 T Nylon PU coated, 1-ply, floor: non-slip PU material, waterproof, framework: 6,9 mm fiberglass, tent pegs: steel, water column: 1200 mm





32153B  
oliv/OD green



32153V  
fleckarn/BW camo

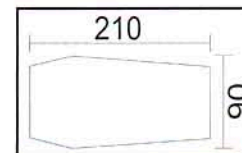

**Tunnelzelt, „Schwarzenberg“**

stabiles 1 Personen-Zelt, mit Moskitonetzeingang und Tragetasche,  
Außenmaterial: 190 T Nylon PU beschichtet, einwandig,  
Boden: trittfestes PU-Gewebe, wasserdicht,  
Gestänge: 6 mm Fiberglas, Heringe: Stahl, Wassersäule: 1200 mm  
Größe/Size: 210 x 90 x 90 cm  
Packmaß/Pack Size: 60 x 9 x 9 cm  
Gewicht/Weight: 1300 g

**Tunnel tent, „Schwarzenberg“**

solid tent for 1 persons, with mosquito net entrance and carrying bag,  
outer shell: 190 T Nylon PU coated, 1-ply, floor: non-slip PU material,  
waterproof, framework: 6 mm fiberglass, tent pegs: steel,  
water column: 1200 mm



32173V  
fleckarn/BW camo



32173B  
oliv/OD green

**Tunnelzelt, „Osser“**

kompaktes 1 Personen-Zelt,  
mit Moskitonetzeingang und Tragetasche,  
Außenmaterial: 210 D Oxford, PU beschichtet,  
Boden: 210 D Oxford PU beschichtet,  
wasserdicht, Gestänge: Aluminium,  
Heringe: Aluminium, Wassersäule: 2000 mm  
Größe/Size: 230 x 80 x 75 cm  
Packmaß/Pack Size: 50 x 16 x 11,5 cm  
Gewicht/Weight: 1300 g

**Tunnel tent, „Osser“**

compact tent for 1 persons,  
with mosquito net entrance and carrying bag,  
outer shell: 210 D Oxford PU coated,  
floor: 210 D Oxford PU material, waterproof,  
framework: aluminium, tent pegs: aluminium,  
water column: 2000 mm

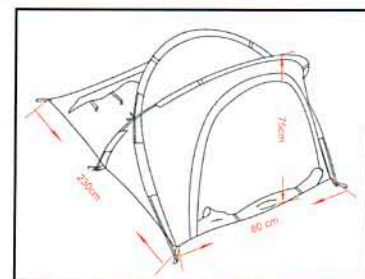



**32183V**  
flecktarn/BW camo



**32183B**  
oliv/OD green

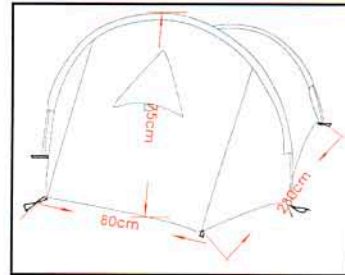

**Tunnelzelt „Arber“**

kompaktes 1 Personen-Zelt, mit Moskitonetzeingang und Tragetasche, Außenmaterial: 190 T Polyester, PU beschichtet, Boden: 210 D Oxford PU beschichtet, wasserdicht, Gestänge: Aluminium, Heringe: Aluminium, Wassersäule: 2000 mm  
 Größe/Size: 230 x 80 x 75 cm  
 Packmaß/Pack Size: 50 x 15 x 10,5 cm  
 Gewicht/Weight: 1400 g

**Tunnel tent „Arber“**

compact tent for 1 persons, with mosquito net entrance and carrying bag, outer shell: 190 T Polyester, PU coated, floor: 210 D Oxford PU material, waterproof, framework: aluminium, tent pegs: aluminium, water column: 2000 mm

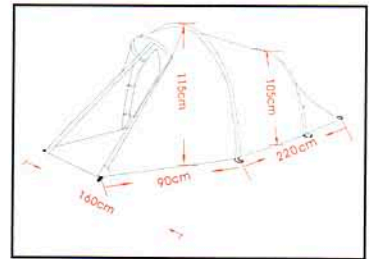

**32193B**

**Tunnelzelt „Falkenstein“**

oliv, kompaktes 2 Personen-Zelt, mit Moskitonetzeingang und Tragetasche, Überdach: 190 T Polyester, PU beschichtet, Innenzelt: atmungsaktives Polyester, Boden: 210 D Oxford PU beschichtet, wasserdicht, Gestänge: Aluminium, Heringe: Aluminium, Wassersäule: 2000 mm  
 Größe/Size: (90+220) x 160 x 115/105 cm  
 Packmaß/Pack Size: 50 x 17,5 x 14 cm  
 Gewicht/Weight: 2400 g

**Tunnel tent „Falkenstein“**

OD green, compact tent for 2 persons, with mosquito net entrance and carrying bag, outer shell: 190 T Polyester, PU coated, inner shell: breathable Polyester, floor: 210 D Oxford PU material, waterproof, framework: aluminium, tent pegs: aluminium, water column: 2000 mm





**33193**  
**US Feldflasche, „Skout“**  
 mit Filzbezug, rund, 1,75 Liter,  
 Alu, Umhängegurt  
**US bottle, „Skout“**  
 felt covered, round, 1,75 l, alu,  
 with shoulder belt



**33211B**  
**US Plastik-Feldflasche**  
 oliv, ohne Bezug, 1 Liter  
**US plastic bottle**  
 OD green, without cover, 1 l



**33223T**  
 woodland

**US Plastik-Feldflasche**  
 1 Liter, Nylonbezug mit kleiner Außentasche,  
 2 Halteklammern zum Befestigen am Gürtel,  
 Koppel oder Rucksack  
**US plastic bottle**  
 1 l, nylon cover with small outside pocket,  
 2 fixing clips for fixing on belt,  
 waist belt or backpack



**33213A**  
 schwarz/black



**33213B**  
 oliv/OD green



**33223V**  
 flecktarn/BW camo



**33263**  
 1 Liter

**Vakuum-Thermoskanne**  
 Schnellverschluss, Edelstahl, unzerbrechlich,  
 mit Tragegriff und Trageriemern,  
 geruchs- und geschmacksneutral  
**Vacuum bottle**  
 quick lock, stainless steel, unbreakable,  
 carrying handle and strap, odor- and tasteless

**Vakuum-Thermoskanne**  
 Schraubverschluss, Edelstahl, unzerbrechlich,  
 geruchs- und geschmacksneutral, oliv  
**Vacuum bottle**  
 screw-cap, stainless steel, unbreakable,  
 odor- and tasteless, OD green

**Vakuum-Thermoskanne**  
 Schnellverschluss, Edelstahl, unzerbrechlich,  
 geruchs- und geschmacksneutral  
**Vacuum bottle**  
 quick lock, stainless steel, unbreakable,  
 odor- and tasteless



**33266**  
 1,5 Liter



**33250**  
 1 Liter



**33249**  
 0,5 Liter



**33253**  
 1 Liter



**33254**  
 0,5 Liter



**33389**  
**Kunststoff-Faltbecher**  
 oliv, 0,25 Liter  
**Fold cup, plastic**  
 OD green, 0,25 l



**33279**  
**Trinkbecher**  
 Teleskop, Edelstahl, 4 cl  
**Drinking cup**  
 telescope, stainless steel, 4 cl



**33277**  
**Trinkbecher**  
 Teleskop, Edelstahl, 15 cl  
**Drinking cup**  
 telescope, stainless steel, 15 cl

**33293**  
**Taschenflasche, „Kanister“**  
 Edelstahl, 6 OZ (170 ml)  
**Jerry can flask**  
 stainless steel, 170 ml



**33271V**  
 flecktarn/BW camo



**33271T**  
 woodland

**Flachmann**  
 Edelstahl, mit Tarnbezug,  
 6 OZ (170 ml)  
**Steel flask**  
 stainless steel,  
 with camo cover, 170 ml



**33273A**  
**Flachmann**  
 Edelstahl, chrom, matt,  
 8 OZ (225 ml)  
**Steel flask**  
 stainless steel, chrome,  
 matt, 225 ml



**33273B**  
**Flachmann**  
 Edelstahl, chrom, matt,  
 6 OZ (170 ml)  
**Steel flask**  
 stainless steel, chrome,  
 matt, 170 ml



**33275A**  
**Flachmann**  
 Edelstahl, oliv, 8 OZ (225 ml)  
**Steel flask**  
 stainless steel, OD green, 225 ml



**33275B**  
**Flachmann**  
 Edelstahl, oliv, 6 OZ (170 ml)  
**Steel flask**  
 stainless steel, OD green, 170 ml



**33553**  
**BW Eßbesteck, schwere Ausführung**  
 4-teiliges Set,  
 (Messer, Gabel, Löffel, Dosen-/Flaschenöffner)  
**BW cutlery set**  
 4-parts, (knife, fork, spoon, can-/bottle opener)



**33563**  
**BW Eßbesteck**  
 Mod., 4-teiliges Set,  
 (Messer, Gabel, Löffel, Dosen-/Flaschenöffner)  
**BW cutlery set**  
 4-parts, (knife, fork, spoon, can-/bottle opener)



**33573**  
**Eßbesteck, „Camping“**  
 zusammenklappbar, olive Griffe,  
 Nylonetui mit Gürteltasche  
 Packmaß/Pack Size: 12 x 7 x 4 cm  
**Cutlery set, „Camping“**  
 foldable, OD green handle,  
 nylon case with belt pocket



**33583**  
**Eßbesteck**  
 3-teilig, Messer klappbar, zusammensteckbar  
 (Messer, Gabel, Löffel, Dosen-, Flaschenöffner),  
 im Nylonetui mit Gürtelschlaufe und Gürtelklammer  
**KEIN EXPORT NACH FRANKREICH!**  
 Packmaß/Pack Size: 15 x 5 x 3 cm  
**Cutlery set**  
 3-parts, handy cutlery foldable,  
 (knife, fork, spoon, can-/bottle opener),  
 nylon case with belt clew and belt clip  
**NO EXPORT TO FRANCE!**  
**L EXPORTATION VERS LA FRANCE EST INTERDITE!**



**33363**  
**US Essgeschirr**  
 Edelstahl  
**US mess kit**  
 stainless steel



**33343**  
**Camping Kunststoffgeschirr**  
 oliv, Falttasse, Besteck,  
 2 Schalen und Schüssel, Streuer  
 mit drei Kammern, Schneidebrett  
**Camping plastic mess kit**  
 OD green, fold cup, 2 shells, 1 bowl,  
 cellar with 3 cells, breadboard





33313

**Kochgeschirr, klein**

Edelstahl, 1 Person, 2 Töpfe (0,7 Ltr., 1 Ltr.) mit Klappgriff, 1 Pfanne mit Klappgriff, 1 Plastiktasse, mit eloxiertem Kupferboden zur besseren Wärmeverteilung, verpackt in Nylonbeutel

Packmaß/Pack Size: 15 x 15 x 9 cm

**Mess kit, small**

stainless steel, for 1 person, 2 pots and 1 pan with hinged handle, plastic cup, copper-bottomed, anodized, for better heat distribution, packaged in nylon bag



33323

**Kochgeschirr, groß**

Edelstahl, 2 Töpfe (1 Ltr., 1,5 Ltr.) mit Klappgriff, 1 Pfanne mit Klappgriff, 2 Plastiktassen, mit eloxiertem Kupferboden zur besseren Wärmeverteilung, verpackt in Nylonbeutel

Packmaß/Pack Size: 18 x 18 x 9,5 cm

**Mess kit, big**

stainless steel, for 2 person, 2 pots and 1 pan with hinged handle, 2 plastic cup, copper-bottomed, anodized, for better heat distribution, packaged in nylon bag



33353

**Kochgeschirr, „De Lux“**

Alu, 1 Pfanne, 1 Topf, 1 Schüssel, 1 Plastik-Tasse

**Mess kit, „De Lux“**

alu, frying-pan, pot, plastic cup, bowl



33365

**Holl. Kochgeschirr**

Alu, 2-teilig

**Dutch mess kit**

Alu, 2 parts





33331

**Kochgeschirr**

Aluminium, eloxiert, klein, besteht aus:  
 1 Pfännchen (150x82 mm), 1 Bratpfanne (154x37 mm),  
 2 Plastikschällchen, 1 Plastikschöpflöffel,  
 1 Plastiklöffel, 1 Reinigungsschwamm, 1 Tragebeutel

**Mess kit**

alu, anodized, small, composed by:  
 1 small frying pan (150x82 mm), 1 frying pan (154x37 mm),  
 2 plastic bowls, 1 plastic ladle, 1 plastic spoon,  
 1 cleaning sponge, 1 carrying bag

33334

**Kochgeschirr**

Aluminium, eloxiert, mittel, besteht aus:  
 1 Topf (173x102 mm), 1 Pfännchen (150x82 mm),  
 1 Bratpfanne (177x39 mm), 3 Plastikschällchen,  
 1 Plastikschöpflöffel, 1 Plastiklöffel,  
 1 Reinigungsschwamm, 1 Tragebeutel

**Mess kit**

alu, anodized, medium, composed by:  
 1 pot (173x102 mm), 1 small frying pan (150x82 mm),  
 1 frying pan (177x39 mm), 3 plastic bowls,  
 1 plastic ladle, 1 plastic spoon,  
 1 cleaning sponge, 1 carrying bag



33337

**Kochgeschirr**

Aluminium, eloxiert, groß, besteht aus:  
 1 Topf (193x130 mm), 1 Topf (173x108 mm),  
 1 Topf (150x82 mm), 1 Bratpfanne (197x50 mm),  
 5 Plastikschällchen, 2 Plastikteller,  
 1 Plastikschöpflöffel, 1 Plastiklöffel,  
 1 Reinigungsschwamm, 1 Tragebeutel

**Mess kit**

alu, anodized, large, composed by:  
 1 pot (193x130 mm), 1 pot (173x108 mm),  
 1 pot (150x82 mm), 1 frying pan (197x50 mm),  
 5 plastic bowls, 2 plastic plates, 1 plastic ladle,  
 1 plastic spoon, 1 cleaning sponge,  
 1 carrying bag





**33383**  
Tasse, Edelstahl  
Gr. 8 x 8 cm, 0,25 Ltr.  
Cup, stainless steel  
size: 8 x 8 cm, 0,25 l



**33384**  
Tasse, Edelstahl  
Gr. 9,5 x 9 cm, 0,5 Ltr.  
Cup, stainless steel  
size: 9,5 x 9 cm, 0,5 l



**33381**  
Tasse, Edelstahl  
doppelwandig, 0,25 Ltr.  
Cup, stainless steel  
double-walled, 0,25 l



**33380**  
Tasse, Edelstahl  
doppelwandig, 0,22 Ltr.,  
mit Kunststoffgriff  
Cup, stainless steel  
double-walled, 0,22 l,  
with plastic handle



**33375**  
Tasse, Edelstahl  
oliv, doppelwandig, 0,22 Ltr.  
Cup, stainless steel  
OD green, double-walled, 0,22 l



**33376**  
Tasse, Edelstahl  
oliv, doppelwandig, 0,35 Ltr.  
Cup, stainless steel  
OD green, double-walled, 0,35 l



**33377**  
Tasse, Edelstahl  
oliv, doppelwandig, 0,45 Ltr.  
Cup, stainless steel  
OD green, double-walled, 0,45 l



**33378**  
Tasse, Edelstahl  
doppelwandig, 0,4 Ltr.,  
mit Kunststoffgriff und Deckel  
Cup, stainless steel  
double-walled, 0,4 l,  
with plastic handle and cap



**33379**  
Tasse, Edelstahl  
doppelwandig, 0,4 Ltr.,  
mit Kunststoffgriff und Deckel  
Cup, stainless steel  
double-walled, 0,4 l,  
with plastic handle and cap

**33388**  
Tasse, „Melamine“  
oliv, 0,35 Ltr.,  
Cup, „Melamine“  
OD green, 0,35 l

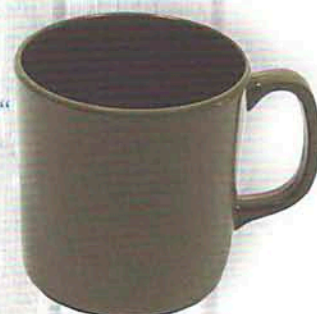

**33393**  
Suppenteller, Edelstahl  
22 cm Durchmesser  
Soup plate, stainless steel  
22 cm diameter



**33396**  
Teller, „Melamine“  
oliv, 25 cm Durchmesser  
Plate, „Melamine“  
OD green, 25 cm diameter



33703

**Gaskocher, klappbar, klein**

mit elektronischer Piezo-Zündung, Edelstahl Brenner, klappbarer Topfständer, Aluminium Ventil, klappbarer Einstelldraht, in stabiler Plastikbox, passend für Schraubventil-Kartusche, Leistung: 1800 Watt  
 Größe/Size: 70 x 65 mm geklappt/fold  
 Gewicht/Weight: 125 g

**Camping stove, foldable, small**

stainless steel burner, foldable pot stand, aluminium valve, electronic ignition included, wire control knob for compact storage, plastic storage box included, fit for screw-on valve gas bottle, output: 1800 watt



33713

**Gaskocher, schwenkbar, klein**

schwenkbar, Edelstahl Brenner, klappbarer Topfständer, Aluminium-Ventil, klappbarer Einstelldraht, passend für Schraubventil-Kartusche, Leistung: 1600 Watt  
 Größe/Size: 70 x 60 cm geklappt/fold  
 Gewicht/Weight: 80 g

**Camping stove, swiveling, small**

pivotable, stainless steel burner, foldable pot stand, aluminium-valve, foldable adjustable wire, suitable for screw-on valve cartridge, output: 1600 watt



33723

**Gaskocher, groß**

Edelstahl Brenner, klappbarer Topfständer, Messing-Ventil, klappbarer Einstelldraht, passend für Schraubventil-Kartusche, Leistung: 1800 Watt  
 Gewicht/Weight: 150 g

**Camping stove, big**

stainless steel burner, foldable pot stand, brass valve, wire control knob for compact storage, fit for screw-on valve gas bottles, output: 1800 watt



33733

**Gaskocher, klappbar**

mit elektronischer Piezo-Zündung, Edelstahl Brenner, klappbarer Topfständer, Aluminium Ventil, elektronische Zündung, klappbarer Einstelldraht, in stabiler Plastikbox, passend für Schraubventil-Kartusche, Leistung: 1800 Watt  
 Größe/Size: 66 x 63 x 83 mm geklappt/fold  
 Gewicht/Weight: 115 g

**Camping stove, foldable**

stainless steel burner, foldable pot stand, aluminium valve, electronic ignition included, wire control knob for compact storage, plastic storage box included, fit for screw-on valve gas bottle, output: 1800 watt

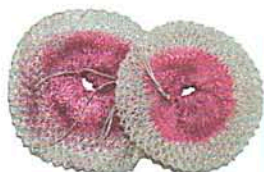

33759

**Glühstrumpf für Gaslaterne**

2 Stk./Pack

**Mantle for gas lamp**

2 pcs/pack



33753

**Gaslaterne**

mit Piezo-Zündung und Tasche, Edelstahl Brenner, Aluminium-Ventil, klappbarer Einstelldraht, elektronische Zündung, passend für Schraubventil-Kartusche, Leistung: 400 Watt

Größe/Size: 120 x 70 mm

Gewicht/Weight: 195 g

**Gas lamp**

with bag, stainless steel burner, aluminium valve, wire control knob for compact storage, electronic ignition included, fit for screw-on valve gas bottles, output: 400 watt



33783

**Gasbrenner**

Edelstahl Brenner, Aluminium-Ventil, elektronische Zündung, passend f. Schraubventil-Kartusche, Leistung: 1900 W

Größe/Size: 140 x 60 mm

Gewicht/Weight: 140 g

**Gas torch**

stainless steel burner, aluminium valve, electronic ignition, fit for screw-on valve gas bottles, output: 1900 watt



33683

**Outdoor-Ofen, „Firepot Typ 120“**

in hochwertiger Edelstahlausführung, Brennerraum, Brennrost und Flammrohr aus hitzebeständigem Edelstahl, Kochtopf mit eloxiertem Kupferboden und klappbaren Griffen, Maße Transportzustand ca.: Länge: 115 mm, Durchmesser: 135 mm, Gewicht: 730 g, funktioneller und leichter Miniöfen, optimale Primär- und Sekundärluftzuführung, enorm gute Verbrennungswerte, für Festbrennstoffe, Fassungsvermögen Kochtopf: ca. 700 ml

**Outdoor-oven, „Firepot Typ 120“**

high quality stainless steel finish, combustion space, combustion grate and flue from heat resistant stainless steel, pot with anodized protherm copper and foldable handles, dimensions in transportation state ca: length: 115 mm, diameter: 135 mm, weight: 730 g, functioning and light mini oven, optimal primary and secondary air supply, extremely good combustion values for solid fuel, capacity pot: ca. 700 ml

33693

**Edelstahl-Kochtopf**

für Outdoor-Ofen „Firepot Typ 120“, mit eloxiertem Kupferboden, Stabilisierungsprofil, Durchmesser: 140 mm, Fassungsvermögen ca.1000 ml

**Stainless steel pot**

for outdoor-oven „Firepot Typ 120“, with anodised copper bottom, stabilized profile, firming profile, diameter: 140 mm, capacity ca. 1000 ml



33903

**Picknick-Box, Holz**

2 Klapphocker, 2 quadratische Teller, 2 Tassen, 2 Eßbestecksets,  
1 Thermoskanne 0,75 L, 3 Vorratsboxen, 1 Flasche,  
1 Einfüllstutzen, 1 hölzernes Käsebrett, 1 Käsemesser,  
Salz- und Pfefferstreuer, 1 abnehmbare Kühltasche, 1 Tischtuch,  
2 Servietten, 1 Flaschen-Kühler, 1 Flaschenöffner

Größe/Size: 52 x 30 x 38 cm

**Picnic box, wooden**

2 folding stools, 2 square plates, 2 cups, 2 set of full flatware,  
1 thermos (0,75 l), 1 round food box, 2 rectangular food boxes,  
1 cylinder bottle, 1 filler, 1 wooden cheese board, 1 cheese knife,  
1 salt & pepper shaker, 1 detachable cooler bag, tablecloth,  
2 serviettes, bottle cooler and opener



33913

**Picknick-Box, Holz**

für 4 Personen,  
4 Gläser, 4 Keramik-Teller,  
4 Essbestecksets, 1 Flaschenöffner

Größe/Size: 46 x 30 x 21 cm

**Picnic box, wooden**

for 4 persons,  
4 glasses, 4 ceramic plates,  
4 sets of flatware, 1 wooden bottle opener



33923

**Picknick-Box, Holz**

für 2 Personen,  
2 Gläser, 2 Kunststoff-Teller, 2 Essbestecksets,  
1 Flaschenöffner, 2 Servietten

Größe/Size: 38 x 26 x 18 cm

**Picnic box, wooden**

for 2 persons,  
2 glasses, 2 melamine plates, 2 sets of flatware,  
1 wooden bottle opener, 2 serviettes



**34653T**

**Fernglas**

woodland, faltbar, 8 x 21, Ruby Linse, 8-fache Vergrößerung, Objektivdurchmesser: 21 mm, Sehfeld: 131 m auf 1000 m, Dioptrienfeineinstellung, Kunststofftasche  
Gewicht/Weight: 185 g

**Binocular**

woodland, foldable, ruby lens, 8 x magnification, lense diameter: 21 mm, field of view: 131 m on 1000 m, diopter fine adjustment, plastic case



**34663T**  
woodland



**34663A**  
schwarz/black



**Fernglas**

faltbar, 10 x 25, Ruby Linse, 10-fache Vergrößerung, Objektivdurchmesser: 25 mm, Sehfeld: 96 m auf 1000 m, Dioptrienfeineinstellung, Kunststofftasche  
Gewicht/Weight: 215 g

**Binocular**

foldable, ruby lens, 10 x magnification, lens diameter: 25 mm, field of view: 96 m on 1000 m, diopter fine adjustment, plastic case



**34603T**

**Monocular**

woodland, 10 x 25, 10-fache Vergrößerung, Objektivdurchmesser: 25 mm, Sehfeld: 96 m auf 1000 m, Dioptrienfeineinstellung, Nylontasche  
Gewicht/Weight: 82 g

**Monocular**

woodland, 10 x 25, 10 x magnification, lens diameter: 25 mm, field of view: 96 m on 1000 m, diopter fine adjustment, nylon case



**34683T**

**Fernglas**

faltbar, 10 x 50, woodland, Ruby Linse, 10-fache Vergrößerung, Objektivdurchmesser: 50 mm, Sehfeld: 105 m auf 1000 m, Dioptrienfeineinstellung, Kunststofftasche  
Gewicht/Weight: 780 g

**Binocular**

foldable, 10 x 50, woodland, ruby lens, 10 x magnification, lens diameter: 50 mm, field of view: 105 m on 1000 m, diopter fine adjustment, plastic case



**34693A**

**Fernglas**

faltbar, 20 x 50, schwarz, 20-fache Vergrößerung, Objektivdurchmesser: 50 mm, Sehfeld: 58 m auf 1000 m, Dioptrienfeineinstellung, Kunststofftasche  
Gewicht/Weight: 780 g

**Binocular**

foldable, 20 x 50, black, 20 x magnification, lens diameter: 50 mm, field of view: 58 m on 1000 m, diopter fine adjustment, plastic case

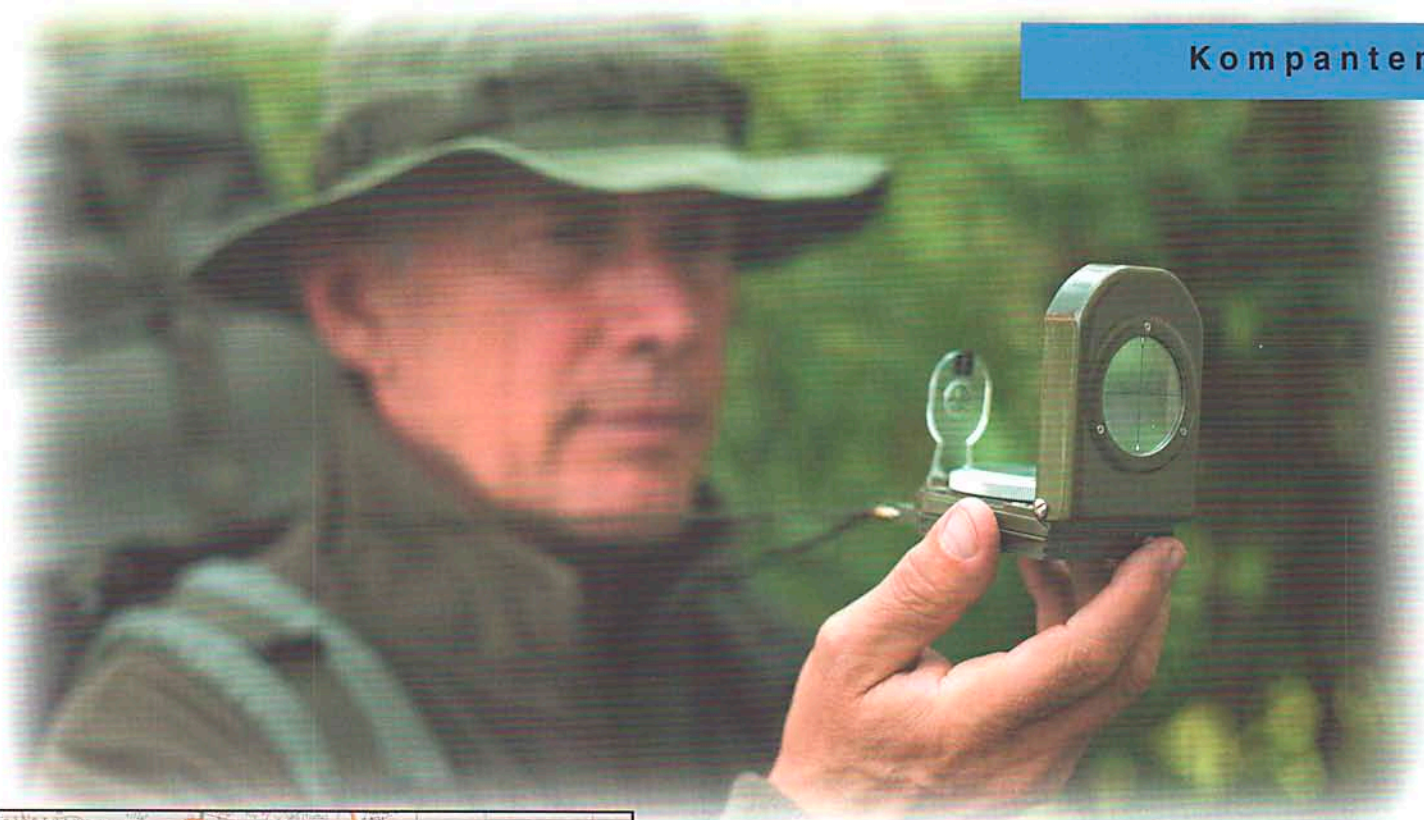

34203

**Karten-Kompaß**

flüssigkeitsgedämpft, Plastikgehäuse, mit Lupe, Meßeinrichtung

**Map compass**

liquid cushioned, plastic body, magnifier, measuring device



34163

**Kompaß, Scout**

flüssigkeitsgedämpft, Plastikgehäuse, Visiereinrichtung im Deckel, Vergrößerungsglas im Sucher

**Compass, scout**

liquid cushioned, plastic body, visor device inside lid, magnifier inside scope

34023

**Kompaß, US-Typ**

Metallgehäuse, flüssigkeitsgedämpft, präzisionsgelagert, übersichtliche Rose, Visiereinrichtung im Deckel, Vergrößerungsglas im Sucher

**Military marching compass**

metal body, liquid cushioned, accurately stocked, lucid rose, visor device inside lid, magnifier inside scope



34043

**Kompaß, „Präzision“**

Peileinrichtung, Metallgehäuse, flüssigkeitsgedämpft, präzisionsgelagert, übersichtliche Rose, Visiereinrichtung im Deckel, Vergrößerungsglas im Sucher, mit Nylon-Etui

**Compass, „Präzision“**

sight wire, metal case, liquid cushioned, accurately stocked, lucid compass rose, visor device inside lid, magnifier inside scope, with nylon case

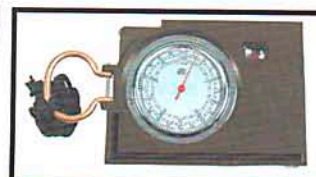
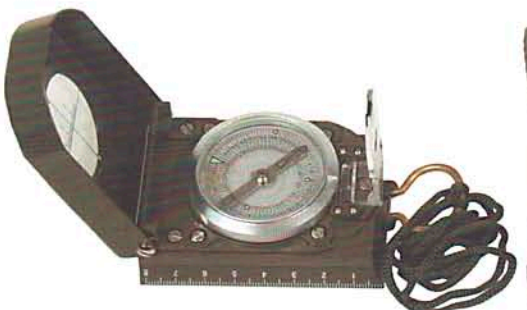

34053

**Kompaß, „Travel“**

Peileinrichtung, Kartenmesser, Neigungsmesser, Nylonnetui, Kunststoffgehäuse mit Alu-Deckel

**Compass, „Travel“**

bearing of direction function, map measure, declinometer, nylon case, plastic body with alu-cover



# Fahnen



35103A  
Deutschland/Germany

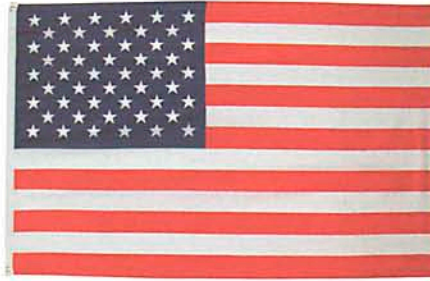

35103C  
USA

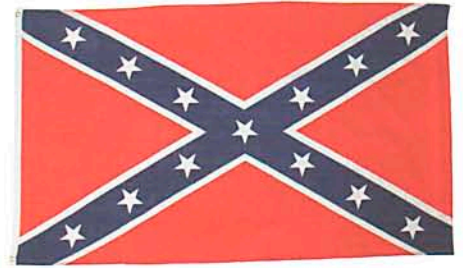

35103D  
Südstaaten/Confederate



35103E  
Großbritannien/United Kingdom



35103F  
Europa



35103I  
Österreich/Austria

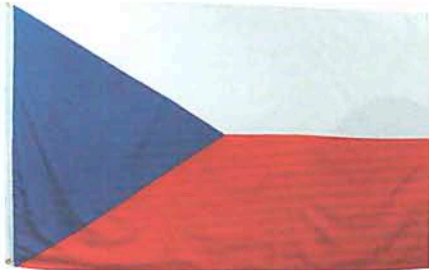

35103J  
Tschechische Republik/Czech Republic



35103K  
Polen/Poland



35103L  
Kanada/Canada



35103M  
Italien/Italy



35103N  
Schweiz/Swiss

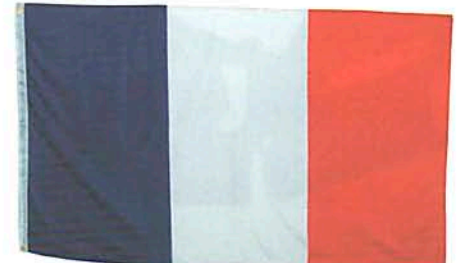

35103O  
Frankreich/France



35103Q  
England



35103R  
Spanien/Spain



**Fahne**  
Polyester, mit Verstärkungsband und Metallösen  
Größe/Size: 90 x 150 cm  
**Flag**  
polyester, with reinforcement band and metal hooks



35105A Baden-Württemberg



35105B Bayern mit Löwen



35105C Berlin



35105D Brandenburg



35105E Bremen



35105F Hamburg



35105G Hessen



35105H Mecklenburg-Vorpommern



35105I Niedersachsen



35105J Nordrhein-Westfalen



35105K Rheinland-Pfalz



35105L Saarland



35105M Sachsen



35105N Sachsen-Anhalt



35105O Schleswig-Holstein

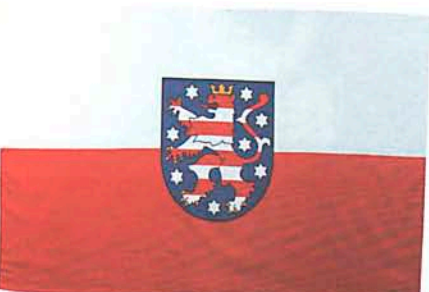

35105P Thüringen

**Fahne, „Bundesländer“**

Polyester, mit Verstärkungsband und Metallösen  
Größe/Size: 90 x 150 cm

**Flag, „German States“**

polyester, with reinforcement band and metal hooks





**35303A**  
Deutschland/Germany



**35303B**  
Bayern/Bavaria



**35303C**  
USA

### Fahne

Polyester, an Holzstiel  
Größe/Size: 30 x 45 cm

### Flag

polyester, with wooden pole



**35403A**  
Deutschland/Germany



**35403B**  
Bayern/Bavaria

### Fähnchen

an Plastikstiel  
Größe/Size: 10 x 15 cm

### Flag

with plastic pole



### 35603

### Fahnenstange

weiß, mit goldfarbenem Adler,  
3-teilig, mit Halter,  
Gesamtlänge: 180 cm

### Flag set

white, golden eagle,  
3-part flagstaff with holder,  
total length: 180 cm

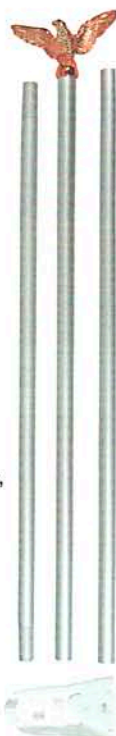



36101A Gefreiter



36101B Obergefreiter



36101C Hauptgefreiter



36101D Stabsgefreiter



36101E Gefreiter UA



36101F Obergefr.UA



36101G Hauptgefreiter UA



36101H Stabsgefr. UA



36101I Unteroffizier



36101J Stabsunteroff.



36101K Feldwebel



36101L Oberfeldw.



36101M Hauptfeldw.



36101N Stabsfeldwebel



36101O Oberstabsfeldw.



36101P Leutnant



36101Q Oberleutnant



36101R Hauptmann



36101S Stabshauptm.



36101T Major



36101U Oberstleutnant



36101V Oberst

36101 silber/silver  
 36121 gelb/yellow  
 36111 schwarz/black  
**BW Rangschlaufen**  
 flecktarn, bestickt  
**BW shoulder loops**  
 BW camo, embroidered



36121A Brigadegeneral



36121B Generalmajor



36121C Generalleutnant



36121D General



36111A Gefreiter



36111B Obergefreiter



36111C Hauptgefreiter



36111D Stabsgefreiter

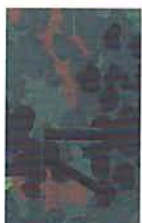

36111E Gefreiter UA

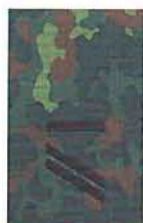

36111F Obergefr.UA



36111G Hauptgefreiter UA



36111H Stabsgefr. UA



36111I Unteroffizier



36111J Stabsunteroff.



36111K Feldwebel



36111L Oberfeldw.



36111M Hauptfeldw.



36111N Stabsfeldwebel



36111O Oberstabsfeldw.



36111P Leutnant

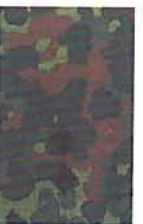

36111Q Oberleutnant



36111R Hauptmann



36111S Stabshauptm.



36111T Major



36111U Oberstleutnant



36111V Oberst



**BW Rangschlaufen**



36021A PSV



36021B Fernmelder



36021C Artillerie



36021D Herresflugabwehr



36021E Feldjäger



36021F Instandsetzung



36021G Nachschub



36021H Pioniere



36021I Topographie



36021J ABC-Abwehr



36021K Musikkorps



36021L Sanitäter



36021M Jäger



36021N Wachbattalion



36021O Panzergrenadier



36021P Fallschirmjäger



36021Q Fernspäher



36021R Heeresflieger



36021S Panzeraufklärer



36021T Panzer



36021U Marinesicherung



36021V Panzerjägertruppe



36021X Luftwaffensicherungstruppe



36021Y KSK



36021Z Heeresaufklärer



36041A Eurocorps



36041B 1. NL/D-Corps



36041C D/F-Brigade

BW Barettabzeichen

Metall

BW beret badge

metal

**SECURITY**



36031B

BW Schirmmützenabzeichen

Luftwaffe

BW peaked cap insignia

airforce



36047

BW Gebirgsjäger-Edelweiß

Metall

BW beret badge, „Edelweiß“

metal



36413A

US Polizeiabzeichen

„Special Police“, mit Anstecknadel

US police badge

„Special Police“, stick pin

36050

Aufnäher, „Security“

silber gestickt, Gr. 30 x 6,5 cm

Badge, „Security“

silver embroidered, Size: 30 x 6,5 cm



36301A  
Größe/Size: 10 x 5 cm

Stickabzeichen  
„VF-31 TOMCATTERS“  
Badge  
„VF-31 TOMCATTERS“



36301B  
Größe/Size: 9,5 x 11,5 cm



36301C  
Größe/Size: 10 x 12 cm



36301D  
Größe/Size: 8 x 8,5 cm



36301E  
Größe/Size: 10,5 x 12 cm



36302A  
Größe/Size: 10,5 x 5 cm



36302B  
Größe/Size: 12 x 14,5 cm



36302C  
Durchmesser/Diameter: 8,5 cm



36302D  
Größe/Size: 10 x 11 cm

Stickabzeichen  
„VF-32 SWORDSMEN“  
Badge  
„VF-32 SWORDSMEN“



36303A  
Größe/Size: 10 x 5 cm



36303B  
Größe/Size: 8 x 11 cm



36303C  
Größe/Size: 9 x 6 cm



36303D  
Größe/Size: 10 x 9,5 cm

Stickabzeichen  
„VF-103 JOLLY ROGERS“  
Badge  
„VF-103 JOLLY ROGERS“

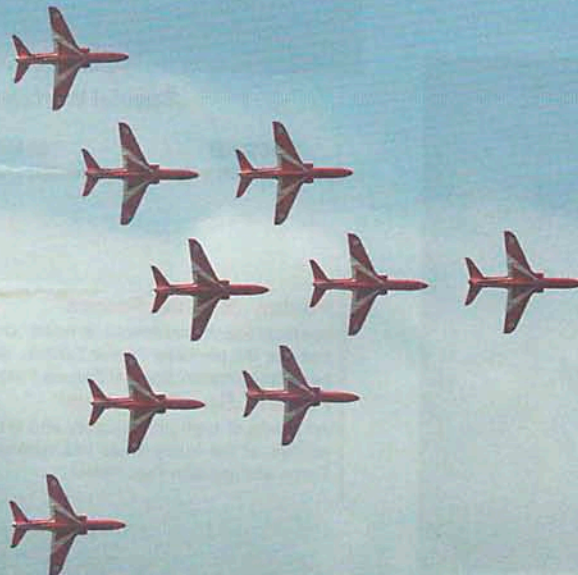

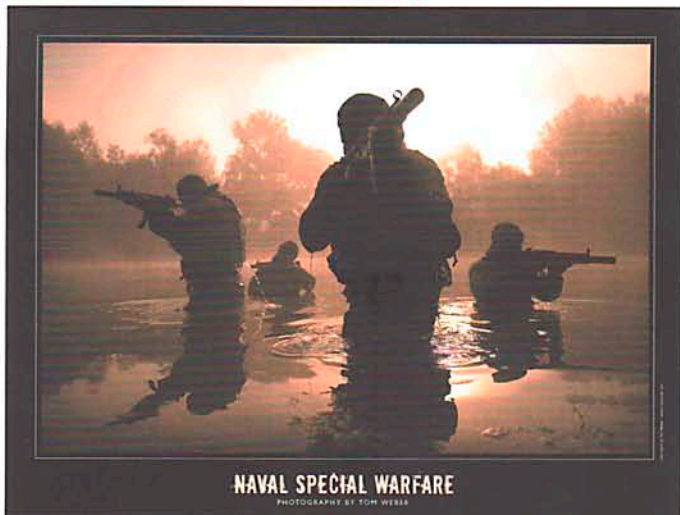

„Naval Special Warfare“

36801A

36805A

36807A

Größe/Size: 50 x 60 cm

Größe/Size: 40 x 50 cm

Größe/Size: 30 x 40 cm

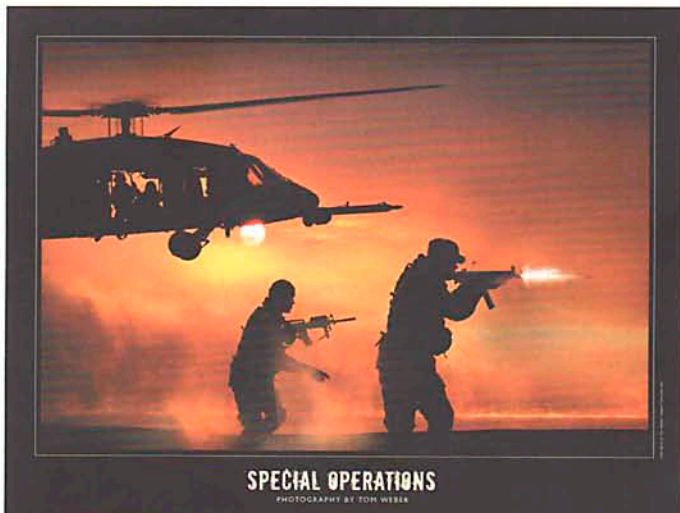

„Special Operations“

36801C

36805C

36807C

Größe/Size: 50 x 60 cm

Größe/Size: 40 x 50 cm

Größe/Size: 30 x 40 cm

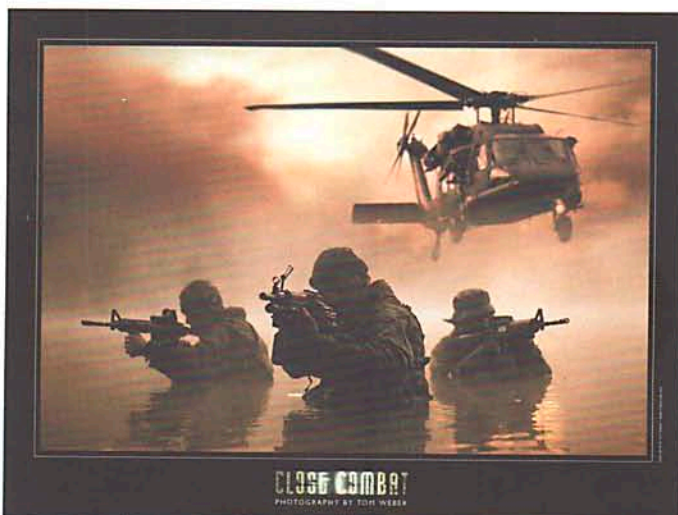

„Close Combat“

36805D

36807D

Größe/Size: 40 x 50 cm

Größe/Size: 30 x 40 cm

**MILpictures**  
www.milpictures.com



**SPECIAL WARFARE OPERATIONS**  
PHOTOGRAPHY BY TOM WEBER

„Special Warfare Operations“

36801B

36805B

36807B

Größe/Size: 50 x 70 cm

Größe/Size: 40 x 50 cm

Größe/Size: 30 x 40 cm

**Poster, „Special Forces“**

hochwertige Kunstdrucke in hoher Druckqualität und Brillanz, aus der MILpictures Poster Edition, des vielfach international ausgezeichneten Special Forces Fotografen Tom Weber

**Poster, „Special Forces“**

art prints of high print quality and brilliance, MILpictures poster edition, of the many times internationally honoured Special Force photograph Tom Weber

www.milpictures.com



**38113**  
**Armbrustpistole, Deluxe**  
 mit Zubehör  
 Verkauf an Personen ab 18 Jahre!  
**Crossbow, Deluxe**  
 with accessories  
 X-rated



**38213**  
**Plastikpfeile**  
 mit Metallspitze, für Armbrustpistole  
**Plastic arrow**  
 with metal arrow head, for crossbow



**38233**  
**Ersatzbogen, für Armbrustpistole**  
 Metall  
**Bow for crossbow**  
 metal



**38223**  
**Sehnen, für Armbrustpistole**  
 Polyester  
**String for crossbow**  
 polyester

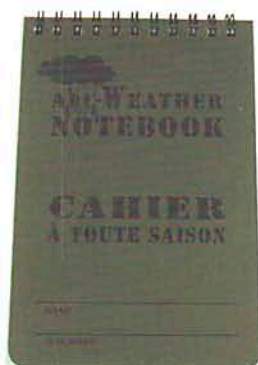

**37503**  
**Meldeblock**  
 wasserfest, klein, Spiralbindung  
 Größe/Size: 10 x 15 cm  
**Writing pad**  
 waterproof, small, spiral binding



**37513**  
**Meldeblock**  
 groß  
 Größe/Size: 11 x 17 cm  
**Writing pad**  
 big



**37403V**  
**Regenschirm**  
 flecktarn, Durchmesser: 1,05 m  
**Umbrella**  
 BW camo, diameter: 1,05 m







37723V  
flecktarn/BW camo



37723Q  
AT-digital



37723Y  
BW tropentarn/BW tropical camo



**Teddybär**  
mit Anzug und Mütze, groß  
Größe/Size: 28 cm  
**Teddybear**  
with suit and cap, big



37733V  
flecktarn/BW camo



37733Q  
AT-digital



37733Y  
BW tropentarn/BW tropical camo

**Teddybär**  
mit Anzug und Mütze, klein  
Größe/Size: 22 cm  
**Teddybear**  
with suit and cap, small



37763  
**Pilotenbär**  
mit Fliegerbrille, klein  
Größe/Size: 14 cm  
**Pilotbear**  
with goggles, small



37753  
**Pilotenbär**  
mit Fliegerbrille, groß  
Größe/Size: 24 cm  
**Pilotbear**  
with goggles, big



37903  
**Wecker „Soldat“**  
woodland  
Größe/Size: 20 cm  
**Alarm clock „soldier“**  
woodland



37805A  
schwarz/black



37805N  
braun/brown



TIME FOR FLIEGER

**Fliegeruhr, „Pilot Automatik“**

Classic Line, handgenähtes Kalbslederarmband, Edelstahlgehäuse, Durchmesser 42 mm, Saphirglas auf Blatt- und Werkseite, 5 ATM wasserdicht, gravierte Edelstahlkrone, Zifferblatt mattschwarz mit Leuchtziffern und indices Leuchtzeiger, Qualitätswerk Miyota 821A, Automatik 21 Steine, mit Zertifikat, in edler Holzbox, MADE IN GERMANY

**Wrist watch pilote, „Pilot Automatic“**

Classic Line, hand sewn calf leather watch band, stainless steel body, diameter 42 mm, sapphire glass at the sheet and work side, 5 ATM water proof, engraved stainless steel crown, face clock, black with shining digits and indices shining clock hand, quality work Miyota 821A, automatics 21 pieces, with certificate, in a fine wooden box, MADE IN GERMANY



**Baseballschläger**

Holz, 32", „American Baseball“  
Länge/Length: 81 cm

**Baseball bat**

wooden, 32", „American Baseball“



39053E silber/silver



39053R natur/nature



39063E silber/silver



39063R natur/nature

**Baseballschläger**

Holz, 26", „American Baseball“  
Länge/Length: 66 cm

**Baseball bat**

wooden, 26", „American Baseball“

**39103**

**Baseballschläger**

ALU, mit Gummigriff, 26"  
Länge/Length: 66 cm

**Baseball bat**

alu, with rubber handle, 26"



**39113**

**Baseballschläger**

ALU, mit Gummigriff, 30"  
Länge/Length: 76 cm

**Baseball bat**

alu, with rubber handle, 30"



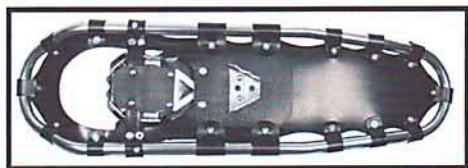

39205

**Schneeschuhe, „Haidel“**

mit Packtasche, Alu-Rahmen, Schnellverschluss, robustes, leichtes Allround-Modell, 7 Aluzacken vorne und 2 x 3 Aluzacken hinten, erhöhen den Halt auf Schnee und Eis, Schuhgröße: 36-47, Länge: 80 cm, Breite: 21 cm, Gewicht: ca. 2300 Gramm/Pair, geeignet für Körpergewicht: 50-90 kg

**Snow boots, „Haidel“**

with bag, aluminium frame, solid and light allround model, quick release fastener, 7 alu jags in front and 2 x 3 alu jags at the back, strengthen the grip on snow and ice, shoe size: 36-47, length: 80 cm, width: 21 cm, weight: ca. 2300 Gramm/pair, adapted for body weight: 50-90 kg



39303

**ALU Trekkingstöcke**

stabiler Trekking-Stock mit ANTISCHOCK-System, Kork-Griff, 3-teilig, gefedert, Griffe mit längenverstellbarer Nylonschleufe, Metallspitze mit Gummiabdeckkappe, 2 verschiedene Teller, Tragebeutel mit verstellbarem Schultergurt,

Länge: geschlossen 70 cm, ausziehbar bis 135 cm

**Alu trekking poles**

stable trekking-pole with ANTISCHOCK-system, cork handle, 3-part, spring-suspended, carries with length adjustable nylon loop, metal point with rubber cover cap, 2 different plates, handle bag with adjustable shoulder belt, length: closed 70 cm, extensible till 135 cm



39241

**Schuhspikes**

schwarz, mit 5 Noppen  
Größen/Sizes: M, L, XL  
**Ice spikes for shoes**  
black, 5 knobs



39243

**Schuhspikes**

schwarz, mit 6 Noppen  
Größen/Sizes: M, L, XL  
**Ice spikes for shoes**  
black, 6 knobs



39245

**Schuhspikes**

schwarz, mit 10 Noppen  
Größen/Sizes: M, L, XL  
**Ice spikes for shoes**  
black, 10 knobs

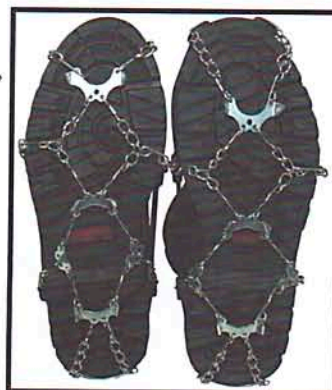

39251

**Schuhschneeketten**

schwarz, 8 Zacken  
**Snow chain for shoes**  
black, 8 spiky

44090

**Bajonett, M10**

mit Kunststoffscheide, schwarz  
 Länge/Length: 30 cm  
 Klinge/Blade: 17 cm  
**Bayonet, M10**  
 with plastic sheath, black

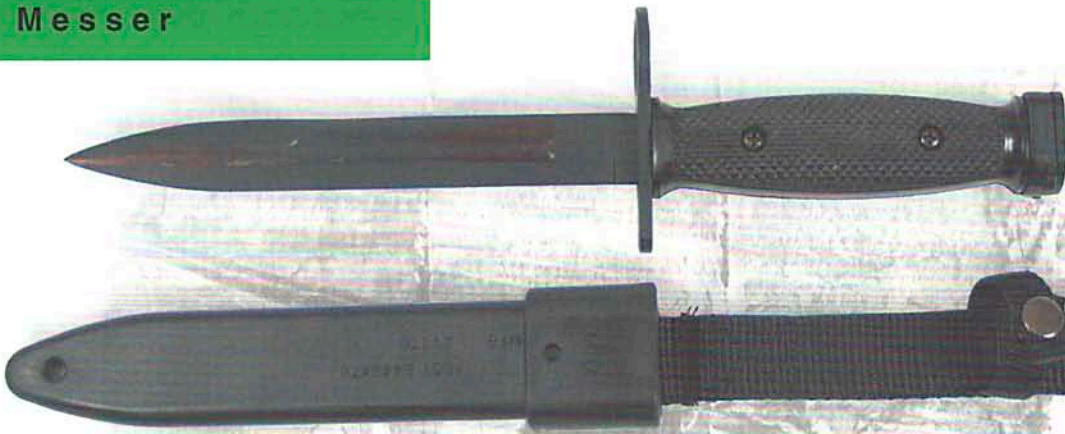

44095

**Bajonett, MK 3**

mit Kunststoffscheide, schwarz  
 Länge/Length: 27 cm  
 Klinge/Blade: 14,7 cm  
**Bayonet, MK 3**  
 with plastic sheath, black

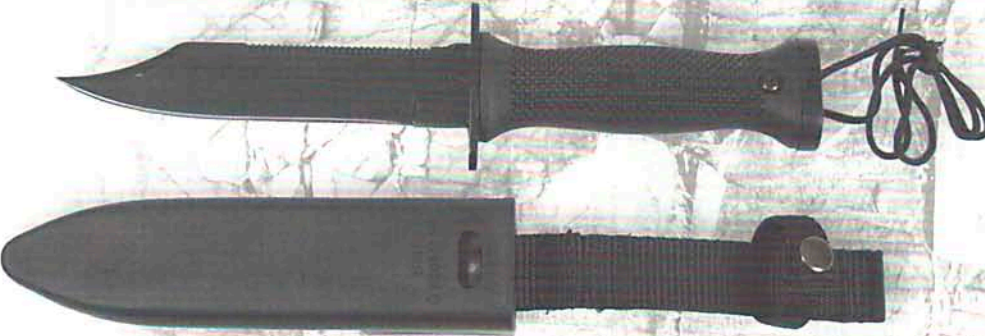

44133

**BW Kampfmesser**

Plastik-Nylon-Scheide, Tanto Klinge,  
 Wellenschliff, Scheibenzertrümmerer,  
 Fangriemen  
 KEIN ORIGINAL!  
 Länge/Length: 30 cm  
 Klinge/Blade: 17 cm  
**BW combat knife**  
 with plastic/nylon sheath, tanto blade,  
 serrated, pane breaker, catch belt  
 NOT ORIGINAL!

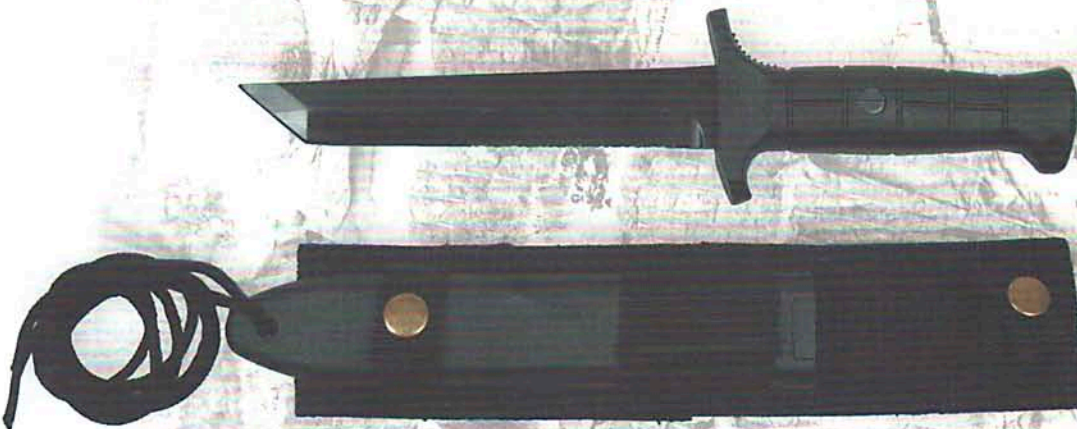

44123

**Bajonett, M9**

mit Plastik/Nylon-Scheide,  
 grüner Kunststoffgriff  
 Länge/Length: 32 cm  
 Klinge/Blade: 19 cm  
**Bayonet, M9**  
 with plastic/nylon sheath,  
 green plastic-handle

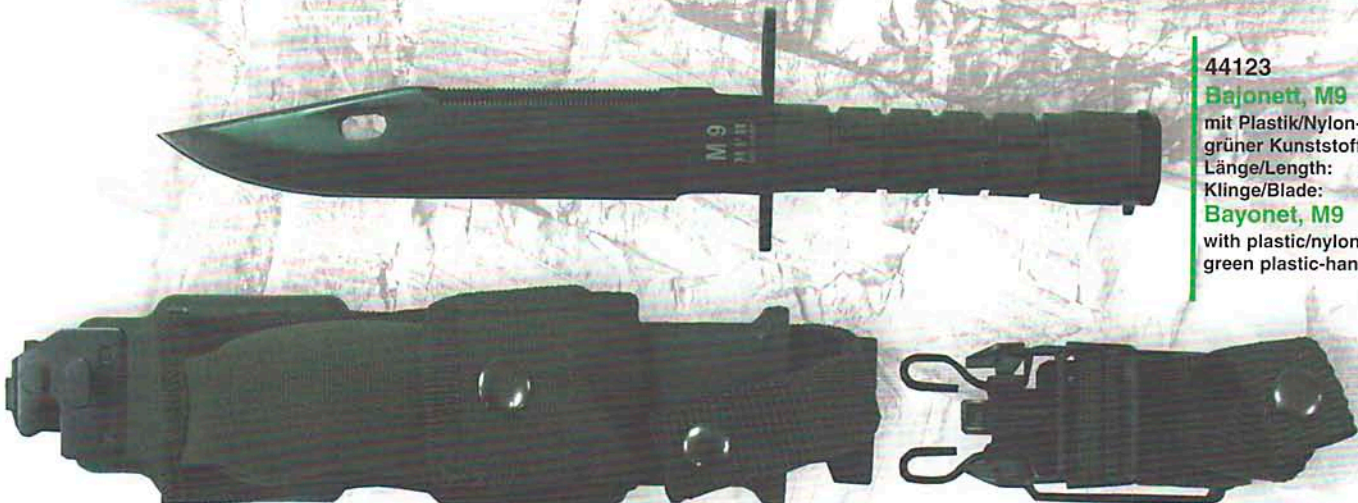



44143

**Überlebensmesser, „Jungle II“**

Alugriff, diverses Zubehör, Plastik-Scheide, Survivalausrüstung im Alugriff, Kompass, Angelzubehör, usw., Schleudervorrichtung, zusätzliche Universalklinge in der Messerscheide

Länge/Length: 35,5 cm

Klinge/Blade: 20,5 cm

**Survival knife, „Jungle II“**

aluminium handle, plastic sheath, survival equipment in the aluminium handle, compass, fishing equipment etc., pitching device, additional universal blade in the sheath



44153

**USMC Kampfmesser**

Griff aus Lederringen, Lederscheide

Länge/Length: 30,5 cm

Klinge/Blade: 17,5 cm

**USMC combat knife**

leather handle, with leather sheath



44163

**Kampfmesser, „Aircrew“**

Ontarioklinge, Lederscheide, Klinge mit Sägerücken und Wellenschliff,

Scheibenzertrümmerer

Länge/Length: 30 cm

Klinge/Blade: 17 cm

**Fighting knife, „Aircrew“**

Ontario blade, with leather sheath, blade with sawback and serrated, window punch

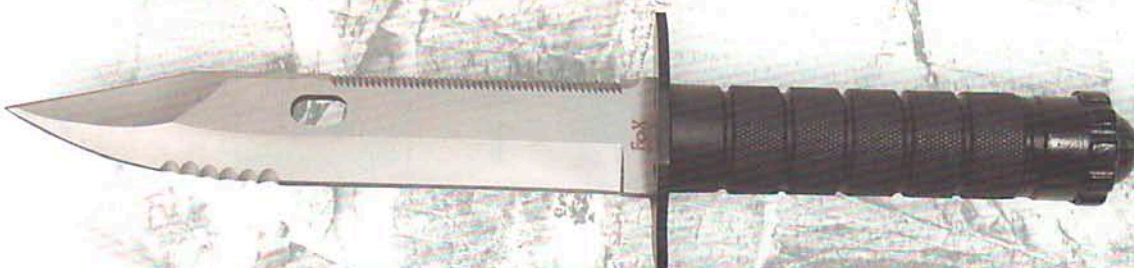

44173

**US-Bajonett**

mit schwarzer Lederscheide, gerippter Kunststoffgriff

Länge/Length: 35,5 cm

Klinge/Blade: 22,5 cm

**US bayonet**

with black leather sheath, ribbed plastic-handle





**44183**  
**Kampfmesser, „Cobra“**  
 gerippter Kunststoffgriff,  
 mit schwarzer Nylonscheide,  
 Nylonscheide mit PVC-Einsatz  
 und aufgesetztem Fach  
 Länge/Length: 30 cm  
 Klinge/Blade: 16,5 cm  
**Fighting knife, „Cobra“**  
 ribbed plastic-handle,  
 with black nylon sheath,  
 sheath with PVC composition  
 and pocket



**44403**  
**Kampfmesser, „Stake“**  
 mit Nylon-Etui, Tantoklinge teilweise  
 mit Sägezähnen, geschraubter  
 Kunststoffgriff, längenverstellbarer  
 Tragegurt, quer und längs  
 tragbar, Schleifstein  
 Länge/Length: 27 cm  
 Klinge/Blade: 15 cm  
**Fighting knife, „Stake“**  
 with nylon sheath, blade partly  
 with saw teeth, screwed on  
 plastic handle, adjustable  
 length, carrying strap,  
 diagonally and alongside  
 portable, grindstone



**44413**  
**Pilotenmesser**  
 mit Nylon/Leder Scheide, schwarz  
 Länge/Length: 27 cm  
 Klinge/Blade: 14 cm  
**Pilot knife**  
 with nylon/leather sheath, black



**44423**  
**Kampfmesser**  
 Kunststoffgriff, Plastisheide,  
 Klinge teilweise mit Sägezähnen,  
 mit Nylon-Befestigungsriemen  
 Länge/Length: 32 cm  
 Klinge/Blade: 19,5 cm  
**Combat knife**  
 plastic handle, plastic sheath,  
 blade is partly with saw teeth,  
 with nylon fixing straps



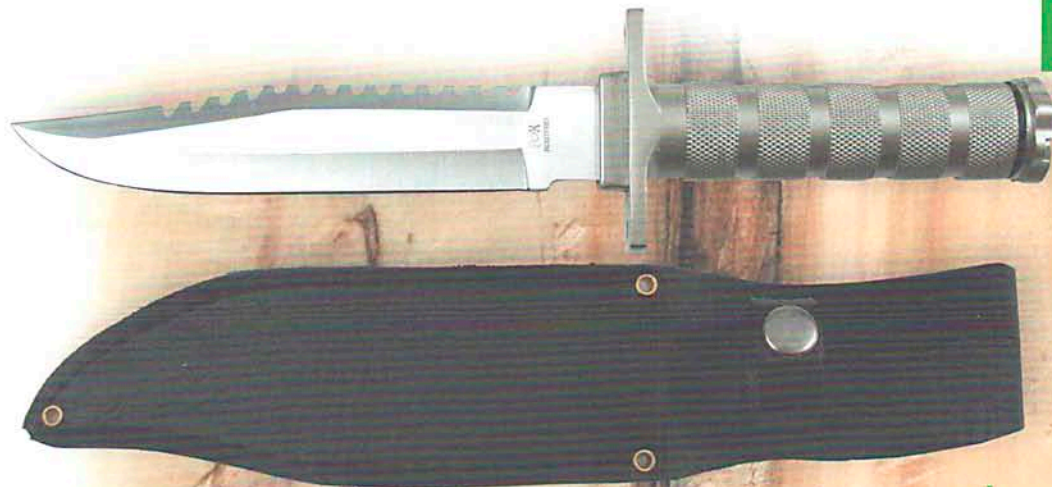

44433

**Überlebensmesser**

Outdoormesser mit Sägerücken, PVC-Scheide, Leichtmetallgriff, Alugriff mit wasserdichter Schraubkrone, kleines Survivalset im Griff  
 Länge/Length: 30 cm  
 Klinge/Blade: 17 cm

**Survival knife**

outdoor knife with sawback, PVC-sheath, light metal handle, aluminium handle with waterproof screw cap, small survival set in the handle



44443

**Überlebensmesser „Pfadfinder“**

schwarz, Survivalausrüstung im Hartkunststoffgriff (Kompass, Angelzubehör, usw.), als Drahtzange und Steinschleuder verwendbar  
 Länge/Length: 26 cm  
 Klinge/Blade: 13,5 cm

**Survival knife „Boyscout“**

black, survival equipment in the hard plastic handle, (compass, fishing equipment etc.), usable as wire cutter and slingshot

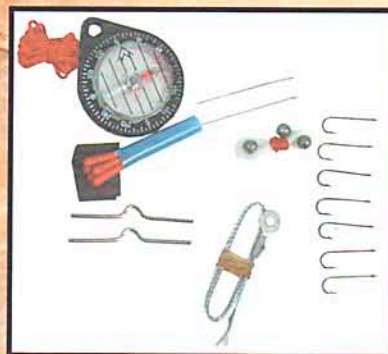

44453

**Überlebensmesser „Special Forces“**

schwarz, Codurafächer am Nylonnetz, mit Kompaß und Survival-Kit, Sägerücken  
 Länge/Length: 32 cm  
 Klinge/Blade: 19 cm

**Survival knife „Special Forces“**

black, codura compartments on the nylon case, with compass and survival-kit, sawback



44463

**BW Fallschirmspringermesser**

Holzgriff, Lederscheide  
 Länge/Length: 27,5 cm  
 Klinge/Blade: 16 cm

**BW knife parachutist**

wooden handle, leather sheath





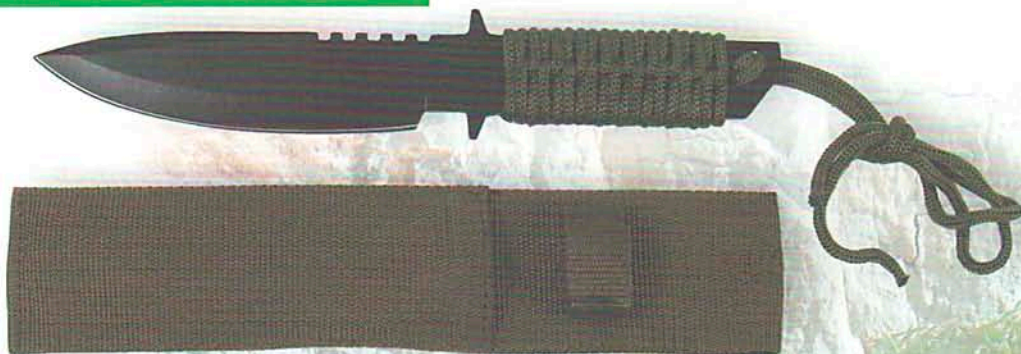

44494  
**Messer, feststehend**  
 Griff mit Nylonband umwickelt,  
 Nylon-Scheide  
 Länge/Length: 27 cm  
 Klinge/Blade: 16 cm  
**Knife, fixed blade**  
 cord wrap handle, nylon sheath



44513  
**Messer, feststehend**  
 gebogene Aufreißklinge, PVC-Griff, Kunststoffscheide  
 Länge/Length: 18 cm  
 Klinge/Blade: 8 cm  
**Knife, fixed blade**  
 bent rip blade, PVC handle, plastic sheath



44543  
**Messer, feststehend**  
 Aufreißklinge, PVC-Griff, Kunststoffscheide  
 Länge/Length: 16,5 cm  
 Klinge/Blade: 10 cm  
**Knife, fixed blade**  
 rip blade, PVC handle, plastic sheath



45063  
**Stiefelmesser**  
 2-schneidig, mit Lederscheide u. Stiefelclip,  
 Gummigriff, durchgehende Klinge mit Loch  
 Länge/Length: 25 cm  
 Klinge/Blade: 15 cm  
**Boot knife**  
 double-edged, leather sheath, boot clip,  
 rubber handle, full-length blade with hole



**Fox**<sup>®</sup>  
 Outdoor



**Wurfmesser**  
 2-schneidig, Nylonscheide,  
 gelochter Griff  
 Länge/Length: 22,5 cm  
 Klinge/Blade: 12 cm  
**Throwing knife**  
 double-edged, nylon sheath,  
 perforated handle

45193Q  
 chrom/chrome

45193A  
 schwarz/black



45301

**Outdoor Messer, „Hunter“**

Nylonscheide mit Gürteltasche,  
Kunststoffgriff mit Fingerkerbe  
Länge/Length: 25 cm  
Klinge/Blade: 11,5 cm

**Outdoor knife, „Hunter“**

nylon sheath with belt loop,  
plastic handle with finger notch



45401

schwarz/black



**Tauchermesser, Beinholster**

Kunststoffgriff mit Sicherung für Etui,  
Reißklinge mit Sägerücken, Kunststoffholster,  
Befestigungsbänder aus Gummi  
Länge/Length: 23 cm  
Klinge/Blade: 11,5 cm

**Diving knife, leg holster**

plastic handle with protection for case,  
riple blade with sawback, plastic holster,  
elastic fixing straps



45402

gelb-schwarz/yellow-black



45451A

schwarz/black



45451Q

AT-digital



45451B

oliv/OD green

**Messerset**

Nylon-Scheide, 1 feststehendes Messer mit Aufreißhaken  
und Wellenschliffklinge, Länge: 21,5 cm, Klinge: 10 cm,  
1 Einhandmesser mit einer gelochter und einer Klinge mit  
Aufreißhaken sowie eine Sägeklinge, Länge: 16,5 cm,  
Klinge: 8 cm, 1 Lampe mit 9 LED's, wasserdichtes  
ALU-Gehäuse, Druckknopf-Schalter, Tragegurt,  
3 AAA Batterie (nicht enthalten), 1 Karabinerhaken

**Knife-set**

nylon sheath, serrated knife, length: 21,5 cm, blade: 10 cm,  
1 knife with perforated and blade with chop to be torn off,  
as well as a saw knife, length: 16,5 cm, blade: 8 cm,  
1 lamp with 9 LED's, water resistant ALU-body,  
press button-switcher, carrying strap,  
3 AAA battery (not included), 1 snap hook



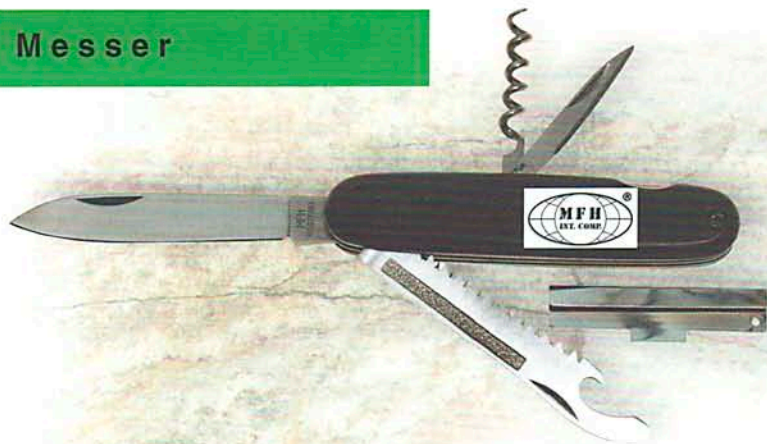

44021

**BW Taschenmesser**

oliv, funktionell mit praktischen Werkzeugen: Messer, Säge, Schraubendreher, Flaschenöffner, Korkenzieher und Stechdorn, Befestigungsöse für Taschenkette

Länge/Length: 19,5 cm

Klinge/Blade: 8,5 cm

**BW pocket knife**

OD green, functional with handy tools: knife, saw, screwdriver, bottle opener, corkscrew and stick thorn, fixing eyelet for pocket chain



44025

**BW Taschenmesser**

oliv, „Einhandöffnung“, funktionell mit praktischen Werkzeugen: Messerklinge mit Wellenschliff, Flaschen-, Dosen- und Büchsenöffner, Ahle, Säge, Schraubendreher, Loch für Fangriemen

Länge/Length: 19,5 cm

Klinge/Blade: 8,5 cm

**BW pocket knife**

OD green, functional with practical tool kit: knife with serrated blade, bottle-, tin and can opener, bodkin, saw, screwdriver, hole for catch straps



44031

**BW Marine-Taschenmesser**

schwarz, Marlspieker 8 cm lang mit Sicherung, Ring für Fangriemen

Länge/Length: 19 cm

Klinge/Blade: 8 cm

**German navy knife**

black, marlinspike 8 cm long with protection, ring for protection straps



44043

**Taschenmesser, „BW Style“**

oliv, funktionell mit praktischen Werkzeugen: Klinge, Säge, Schraubendreher, Flaschenöffner, Zange, Korkenzieher und Stechdorn, Befestigungsöse für Taschenkette, schwarzes Nylon-Etui

Länge/Length: 19,5 cm

Klinge/Blade: 8,5 cm

**Pocket knife, „BW style“**

OD green, functional with handy tools: blade, saw, screwdriver, bottle opener, pliers, corkscrew and stickthorn, fixing eyelet for pocket chain, black nylon case



44063

**Taschenmesser-Set**

oliv, mit Gabel, Löffel und Lampe, funktionell mit praktischen Werkzeugen: Messer, Schraubendreher, Aale, Flaschenöffner, Korkenzieher und Stechdorn, Befestigungsöse für Taschenkette, Nylonetui

Länge/Length: 18,5 cm

Klinge/Blade: 8 cm

**Pocket knife set**

OD green, with fork, spoon and lamp, functional with handy tools: knife, screwdriver, bottle opener, corkscrew and stick thorn, fixing eyelet for pocket chain, nylon sheath





44065

**Taschenmesser-Set**

oliv, mit Gabel und Löffel, Dosenöffner, funktionell mit praktischen Werkzeugen: Messer, Schraubendreher, Aale, Flaschenöffner, Korkenzieher und Stechdorn, Befestigungsöse für Taschenkette, Nylonseti  
 Länge/Length: 18,5 cm  
 Klinge/Blade: 8 cm

**Pocket knife set**

OD green, with fork, spoon, can opener, functional with handy tools: knife, screwdriver, bottle opener, corkscrew and stick thorn, fixing eyelet for pocket chain, nylon sheath



44553

**Klappmesser**

Edelstahl, Gummigriff  
 Länge/Length: 15 cm  
 Klinge/Blade: 6,5 cm

**Jack knife**

stainless steel, rubber handle



44563

**Klappmesser**

Edelstahl, Gummigriff  
 Länge/Length: 19 cm  
 Klinge/Blade: 8 cm

**Jack knife**

stainless steel, rubber handle

**Fox<sup>®</sup>**  
*Outdoor*



44573

**Klappmesser**

Edelstahl, Gummigriff  
 Länge/Length: 22 cm  
 Klinge/Blade: 10 cm

**Jack knife**

stainless steel, rubber handle



44583B

**Klappmesser, Einhand**

Metallgriff mit Holzeinlage, Gürtelclip  
 Länge/Length: 16 cm  
 Klinge/Blade: 7 cm

**Jack knife, one-handed**

metallic handle with wood inlays, belt clip



44593

**Klappmesser, Einhand**

Metallgriff mit Gummieinlage, Gürtelclip, Klinge gelocht  
 Länge/Length: 21,5 cm  
 Klinge/Blade: 9,5 cm

**Jack knife, one-handed**

metallic handle with rubber inlays, belt clip, blade perforated



44603

**Klappmesser, Einhand**

Gürtelclip, Wellenschliff, Metallgriff mit Gummieinlage  
 Länge/Length: 19 cm  
 Klinge/Blade: 8 cm

**Jack knife, one-handed**

belt clip, serrated edge, metal handle, with rubber inlay



44613

**Klappmesser, Einhand**

Gürtelclip, Metallgriff  
 Länge/Length: 19 cm  
 Klinge/Blade: 8,5 cm

**Jack knife, one-handed**

belt clip, metal handle



**44623**  
**Klappmesser, Einhand**  
 Gürtelclip, gelochter Griff, Metallgriff  
 Länge/Length: 19,5 cm  
 Klinge/Blade: 8,5 cm  
**Jack knife, one-handed**  
 belt clip, perforated handle, metal handle



**44643**  
**Klappmesser, Einhand**  
 Chrom-Edelholz-Griff  
 Länge/Length: 17 cm  
 Klinge/Blade: 7,5 cm  
**Jack knife, one-handed**  
 chrome/precious timber handle



**44773**  
**Klappmesser, Einhand**  
 schwarzer Griff mit Gummieinlage  
 und Gürtelclip  
 Länge/Length: 21,5 cm  
 Klinge/Blade: 9,5 cm  
**Jack knife, one-handed**  
 black handle with elastic inlay  
 and beltclip



**44803**  
**Klappmesser**  
 mit Verzierung und Holzgriff  
 Länge/Length: 21 cm  
 Klinge/Blade: 8,5 cm  
**Jack knife**  
 with wooden handle and ornamentation



**44823**  
**Klappmesser, Einhand**  
 schwarz, mit Griffschalen aus Holz, beschichtet,  
 mit Gürtelclip  
 Länge/Length: 20,5 cm  
 Klinge/Blade: 8,5 cm  
**Jack knife, one-handed**  
 wooden grip plates, black coated, with beltclip



**44833**  
**Klappmesser, Einhand**  
 mit Griffschalen aus Edelholz, beschichtet,  
 silberne Klinge  
 Länge/Length: 20,5 cm  
 Klinge/Blade: 8,5 cm  
**Jack knife, one-handed**  
 with grip plates made of precious timber,  
 coated, silver blade



**44843**  
**Klappmesser, „Hunter“**  
 Metallgriff mit Holzeinlage,  
 Messer, Säge, Flaschenöffner  
 Länge/Length: 22 cm  
 Klinge/Blade: 9,5 cm  
**Jack knife, „Hunter“**  
 metal with timber inlay,  
 knife, saw, bottle opener

**Fox**<sup>®</sup>  
 Outdoor



44853

**Klappmesser, „Jäger“**

mit aufwendiger Backenverzierung,

weiße Schale, mit Jagdmotiv

Länge/Length: 19 cm

Klinge/Blade: 8,5 cm

**Jack knife, „Hunter“**with elaborate jaw ornamentation,  
white grip plate, hunting scene

44893

**Klappmesser, Einhand**

mit Schalen aus Pakkaholz,

Backen aus Edelstahl

Länge/Length: 22,5 cm

Klinge/Blade: 9,5 cm

**Jack knife, one-handed**with grip plates made of pakka-wood,  
jaws made of stainless steel

45481

**Klappmesser, mit Struktur-Klinge**

Einhand, schwarzer Griff, mit Gürtelclip

Länge/Length: 19,5 cm

Klinge/Blade: 8,5 cm

**Jack knife, structure blade**

one-handed, black handle, belt clip



45491

**Klappmesser, mit Struktur-Klinge**

Einhand, schwarzer Griff, mit Gürtelclip

Länge/Length: 20 cm

Klinge/Blade: 8,5 cm

**Jack knife, structure blade**

one-handed, black handle, belt clip



45501

**Klappmesser, Einhand**

Gurtschneider, schwarz, Metallgriff,

Gürtelclip, Dorn als Glasbrecher

Länge/Length: 24 cm

Klinge/Blade: 10 cm

**Jack knife, one-handed**belt cutter, black, metal handle,  
belt clip, spike as glass breaker

45511

**Klappmesser, Einhand**

Zackenrücken, schwarz,

Metallgriff mit Verzierung, Gürtelclip

Länge/Length: 23,5 cm

Klinge/Blade: 10 cm

**Jack knife, one-handed**prongs, black,  
metal handles with decoration, belt clip

45541

**Klappmesser, Einhand**

Chromgriff, geschlitzte Klinge u. Griff

Länge/Length: 19,5 cm

Klinge/Blade: 7,5 cm

**Jack knife, one-handed**

chrome handle, slit blade and handle



45621

**Klappmesser, Einhand**

mit Gürtelclip, Edelstahlgriff  
gelocht, schlanke Form

Länge/Length: 21 cm  
Klinge/Blade: 8,5 cm

**Jack knife, one-handed**

belt clip, stainless steel handle,  
perforated handle, slim form



45731

**Klappmesser**

Klinge gebogen, teilweise mit  
Sägezähnen, Griff mit Gummieinlage

Länge/Length: 16 cm  
Klinge/Blade: 7 cm

**Jack knife**

bent blade, partly saw teeth,  
handle with rubber inlay

**Fox**<sup>®</sup>  
Outdoor



45761

**Klappmesser, Einhand**

blau, Klinge teilweise mit Sägezähnen,  
geschlitzter Griff, mit Gürtelclip

Länge/Length: 20 cm  
Klinge/Blade: 8,5 cm

**Jack knife, one-handed**

blue, slit handle, saw blade,  
slit blade, belt clip



45811

**Klappmesser, Einhand**

Titan beschichtet, Gürtelclip

Länge/Length: 19,5 cm  
Klinge/Blade: 8 cm

**Jack knife, one-handed**

titanium coated, belt clip



45841A

**Klappmesser, Einhand**

schwarz, gelochter Griff, mit Gürtelclip,  
Damaststruktur-Klinge

Länge/Length: 19 cm  
Klinge/Blade: 7,5 cm

**Jack knife, one-handed**

black, perforated handle, belt clip,  
damask-structure blade



45851

**Klappmesser, Einhand**

Griff mit aufgesetzter Metallverzierung, Gürtelclip,  
Damaststruktur-Klinge

Länge/Length: 17,5 cm  
Klinge/Blade: 7,5 cm

**Jack knife, one-handed**

handle with superimposed metallic ornamentation,  
with belt clip, damask-structure blade



45861

**Klappmesser, Einhand**

Gurtschneider, schwarz, Gürtelclip,  
Klinge mit Wellenschliff,  
Dorn als Glasbrecher

Länge/Length: 20 cm  
Klinge/Blade: 8,5 cm

**Jack knife, one-handed**

belt cutter, black, belt clip,  
blade with serrated edge,  
spike as glass breaker



45871

**Klappmesser, Einhand**

Carbon, 8 verschiedene Biteinsätze, (2 Kreuzschlitz,  
2 Schlitzschrauben, 2 Torx, 2 Inbus)

Länge/Length: 20,5 cm  
Klinge/Blade: 8,5 cm

**Jack knife, one-handed**

carbon, 8 different bits,  
(2 cross recess, 2 slotted head, 2 torx, 2 hexagon)



45881

**Klappmesser, Einhand**

Gurtschneider, Gürtelclip, Metallgriff mit Kunststoffeinlage, Dorn als Glasbrecher  
 Länge/Length: 20 cm  
 Klinge/Blade: 8,5 cm

**Jack knife, one-handed**

belt cutter, belt clip, metal handle with artificial insole, spike as glass breaker



45901

**Klappmesser**

Metall-Edelholz-Griff, Edelstahl, gelochter Griff und Klinge  
 Länge/Length: 22,5 cm  
 Klinge/Blade: 9,5 cm

**Jack knife**

metallic fine wood handle, stainless steel, perforated blade and handle



45911

**Klappmesser, Einhand**

Chrom-Edelholzgriff, mit Gürtelclip  
 Länge/Length: 19,5 cm  
 Klinge/Blade: 8,5 cm

**Jack knife, one-handed**

chrome/precious timber handle, belt clip



45921

**Klappmesser, Einhand**

geschlitzte Klinge, Metall-Edelholz-Griff, mit Gürtelclip  
 Länge/Length: 23 cm  
 Klinge/Blade: 9,5 cm

**Jack knife, one-handed**

perforated blade, metallic/precious timber handle, belt clip



45931

**Klappmesser, Einhand**

Metall-Edelholz-Griff, mit Gürtelclip, Fingerrillen  
 Länge/Length: 21 cm  
 Klinge/Blade: 9,5 cm

**Jack knife, one-handed**

metallic/precious timber handle, belt clip, finger grooves



45941

**Klappmesser, Einhand**

grün-schwarzer Kunststoffgriff, schwarze Klinge, Gürtelclip  
 Länge/Length: 19,5 cm  
 Klinge/Blade: 8,5 cm

**Jack knife, one-handed**

blackish-green plastic handle, black blade, belt clip



45951

**Klappmesser, Einhand**

Edelstahlgriff mit grüner Kunststoffeinlage, Gürtelclip, gelochter Griff  
 Länge/Length: 20,5 cm  
 Klinge/Blade: 8,5 cm

**Jack knife, one-handed**

handle made of stainless steel with green plastic inlay, belt clip, perforated handle





46103

**Messerschärfer**

oliv, V-förmiger Abziehstahl,

Öse für Fangriemen

Material: Kunststoff/Plastic

Größe/Size: 14,5 x 1,5 cm

**Knife sharpener**

OD green, V-form detachable steel, eyelet for catch straps



46105

**Messerschärfer „DUO“**

oliv, für 2 unterschiedliche Schärfsysteme, Carbit für Grobschliff und Keramik für Feinschliff, Gehäuse mit Gummiauflage

Material: Kunststoff/Plastic

Größe/Size: 5,7 x 7,5 x 2,4 cm

**Knife sharpener „DUO“**

OD green, for 2 different sharpening systems, carbit for rude polish and ceramics for fine polish, box with rubber layer



46722

**Messer-Etui**

groß, schwarz, Nylon, quer und längs tragbar

**Knife case**

large, black, nylon, portable diagonally and alongside



46712

**Messer-Etui**

klein, schwarz, Nylon, quer und längs tragbar

**Knife case**

small, black, nylon, portable diagonally and alongside



46724A  
schwarz/black



46724B  
oliv/OD green



46724J  
CZ tarn/CZ camo

**Messer-Etui**

Nylon, quer und längs tragbar, Größe: 15 x 6 cm

**Knife case**

nylon, size: 15 x 6 cm

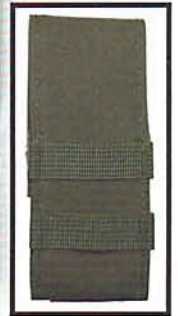

46732A  
schwarz/black



46732N  
braun/brown

**Messer-Etui**

Leder, Heftlänge bis 13 cm

**Knife case**

leather, length: 13 cm



46734A  
schwarz/black



46734N  
braun/brown

**Messer-Etui**

Leder, Heftlänge bis 11 cm

**Knife case**

leather, length: 11 cm

**Fox**<sup>®</sup>  
Outdoor



46736A  
schwarz/black



46736N  
braun/brown

**Messer-Etui**  
Leder, Heftlänge bis 13 cm, quer tragbar  
**Knife case**  
leather, length: 13 cm, transverse

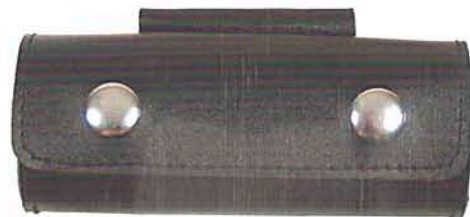

46738A  
schwarz/black



46738N  
braun/brown



## Größen / Sizes

### BW Hosen / BW pants

Natogr.:	1	2	3	4	5	6	7	8	9	10	11	12	13	14	15
Zivilgr.:	23	24	25	26	27	46	48	50	52	54	56	98	102	106	110

### BW Jacken, Parka, Kombis / BW jackets

Natogr.:	1	2	3	4	5	6	7	8	9	10	11	12	13	14
Zivilgr.:	23	24	25	26	46	48	50	52	54	94	98	102	106	110

### Kinderbekleidung / Children's wear

US-Gr.:	XXS	XS	S	M	L	XL	XXL
Deutsch:	98/104	110/116	122/128	134/140	146/152	158/164	170/176

### Shirts, Hosen, US Jacken, Westen / Shirts, Pants, US jackets, Vests

US-Gr.:	XXS	XS	S	M	L	XL	XXL	XXXL	4XL	5XL
Deutsch:	38/40	42/44	46	48/50	52/54	56	58/60	62	64	66

### Schuhe, Stiefel / Shoes, Boots

Gr.:	2	3	4	5	6	7	8	9	10	11	12	13
Deutsch:	36	37	38	39	40	41	42	43	44	45	46	47

### Kopfbedeckungen / Headpieces

US-Gr.:	XS	S	M	L	XL	XXL
Deutsch:	53/54	55/56	57/58	59/60	61/62	63/64

### Unterwäsche / Underclothing

Gr.:	4	5	6	7	8	9	10
Deutsch:	42/44	44/46	48/50	52/54	56/58	60/62	64/66

### Handschuhe / Gloves

US-Gr.:	S	M	L	XL	XXL
Deutsch:	7	8	9	10	11

### Damenhosen / Women pants

US-Gr.:	XXS	XS	S	M	L	XL	XXL
Deutsch:	32	34	36	38	40	42	44

### Girly-Hosen / Girly pants

US-Gr.:	26	27	28	29	30	31
Deutsch:	32	34	36	38	38/40	40

### Worker-Jeans-Hosen (Herren) / Worker-jeans-pants (men)

US-Gr.:	29	30	31	32	33	34	36
Deutsch:	40	42	44	46	48	50	52

### BW Schuhe, Stiefel / BW Shoes, Boots

Natogr.:	250	255	260	265	270	275	280	285	290	295	300	305	310
Zivilgr.:	39	40	40,5	41	42	43	43,5	44	45	46	46,5	47	48

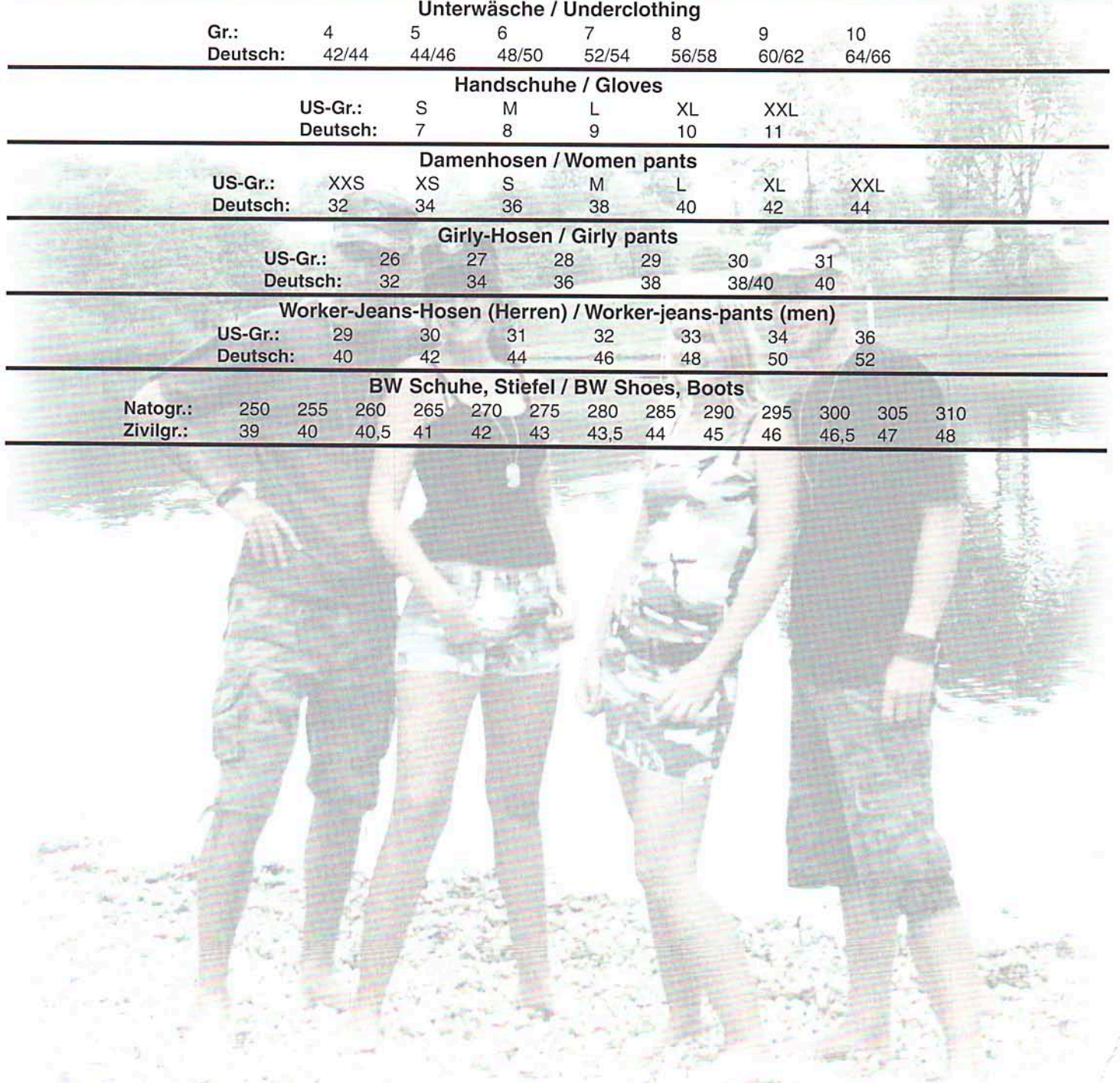

## Stickerei • Flock / Embroidery • Transfers

Nutzen Sie unseren Veredelungsservice!

### Stickerei & Flock

bieten eine attraktive Kooperation zur Herstellung von Promotionwear.

Geben Sie Ihren Kunden die Möglichkeit, sich, ihr Unternehmen oder Philosophie mittels Veredelung in den Mittelpunkt zu setzen! Wir helfen Ihnen dabei!

**Patches, Direkteinstickung, Flocktransfers, Nähservice und vieles mehr!**

Individuelle Beratung und Auftragsabwicklung nach DIN-Norm sind selbstverständlich.

**Direktimporte geben uns die Möglichkeit, Grossaufträge nach Ihren individuellen Wünschen kostengünstig auszuführen.**

Alle zur Veredelung geeigneten Produkte unseres Sortiments sind meist kurzfristig verfügbar.

Schnelle Lieferzeiten sind durch unseren "in-House" Veredelungs-Service garantiert.

**Sie benötigen T-Shirts, Caps etc. ausserhalb unseres Sortiments?**

**Frotteeware, Taschen, Kinderbekleidung oder Regenschirme?**

Gerne bieten wir Ihnen auf Anfrage Waren führender Hersteller zu günstigen Preisen.

**Sprechen Sie mit uns!**

### Embroidery & Transfers

build an attractive cooperation to create promotionwear.

Offer your customers the possibility to be always in the centre of interest. We are to your assistance.

**Patches, embroidery on any kind of textile, transfers, sewing-service and much more!**

Individual advice and order procedure in accordance with DIN is guaranteed.

**Direct imports of manufacturers offer the possibilities to order your design in big quantities on lower-cost.**

All products of our stock which can be refined by our "in-house" Service are available in short-term.

**You need T-Shirts, Caps etc. beyond our assortment? Terrycloth, bags, kidswear or umbrellas?**

We offer articles of leading producers on request.

**Always to your assistance!**



# Allgemeine Geschäftsbedingungen

## 1. Allgemein / Geltungsbereich

Unsere Lieferungen, Leistungen und Angebote erfolgen aufgrund unserer nachstehenden allgemeinen Geschäftsbedingungen. Alle unsere Angebote sind freibleibend und richten sich ausschließlich an Unternehmer und gewerbliche Wiederverkäufer, nicht jedoch an Verbraucher. Geschäftsbedingungen des Kunden (z. B. auf Auftrag) haben für uns keine Wirksamkeit, falls wir diese nicht schriftlich anerkannt haben! Sämtliche angegebene Preise (Preisliste, Onlineshop, Angebote u. a.) sind zuzüglich der geltenden Mehrwertsteuer. Ein Kaufvertrag kommt erst zustande, wenn wir die bestellte Ware an Sie versenden.

## 2. Lieferbedingungen

Die Lieferung erfolgt unfrei ab Lager Freyung. Mit der Übergabe der Ware an den Transporteur sind unsere Leistungen erfüllt, die Gefahr geht auf den Besteller über! Falls nicht ausdrücklich vereinbart, sind wir zu Teillieferungen berechtigt. Mangels anderweitiger Vereinbarung wählen wir den Beförderer.

## 3. Mindestbestellwert

Der Mindestbestellwert (ohne Mehrwertsteuer) pro Sendung beträgt EUR 100,-. Bei Bestellungen unter diesem Betrag werden EUR 5,- Mindermengenzuschlag berechnet. Bei der Erstbestellung ist der Mindestbestellwert EUR 500,-. Nachbestellungen zu bestehenden Aufträgen sind aus organisatorischen Gründen nicht möglich! Lieferung erfolgt nur in den angegebenen Verpackungseinheiten (VE)!

## 4. Zahlungsbedingungen

Die Lieferung erfolgt per Nachnahme oder Vorkasse.

## 5. Eigentumsvorbehalt

Die von uns gelieferte Ware bleibt bis zur vollständigen Bezahlung unser Eigentum, auch zukünftig entstehende Forderungen gegenüber dem Käufer, mit dem Recht der Aussonderung oder Ersatzaussonderung, auch im Falle der Vermischung, der Be- und Verarbeitung oder anderweitiger Veränderungen.

## 6. Mängelrügen und Haftung

Mängelrügen des Bestellers können nur berücksichtigt werden, wenn sie innerhalb von 14 Tagen nach Empfang der Ware, bzw. bei verborgenen Mängeln nach deren Entdeckung schriftlich beim Verkäufer angezeigt werden.

Rückgaben infolge berechtigter Mängel müssen innerhalb von 14 Tagen franko nach vorheriger Vereinbarung erfolgen. Eine Rückholung durch UPS ist nach vorheriger Absprache möglich!

Gebrauchtware wird verkauft wie sie „steht und liegt“ unter Ausschluss jeder Gewährleistung.

Dies gilt auch für ungebrauchte Original-Militär-Ware.

Wir vertreiben keine Produkte, von denen wir wissen, dass sie mit Rechten Dritter, insbesondere mit gewerblichen Schutzrechten (Patente, Gebrauchsmuster, Geschmacksmuster, Marke) belastet sind. Wir übernehmen jedoch keinerlei Haftung dafür, dass die von uns gelieferte Ware nicht frei von Rechten Dritter ist. Insbesondere haben wir die Waren nicht auf die Freiheit von Rechten Dritter geprüft. Wir schließen jede Verantwortung gegenüber dem Besteller für Fälle aus, in denen dieser wegen angeblicher oder tatsächlicher Verletzung von gewerblichen Schutzrechten Dritter in Anspruch genommen wird. Für den Fall, dass ein Verletzungsfall auftritt, haben wir das Recht, die Lieferung der verletzenden Produkte sofort einzustellen.

## 7. Datenschutz

Daten des Kunden erheben wir nur im Rahmen der Abwicklung von Verträgen. Dabei werden die gesetzlichen Vorgaben, insbesondere des Telemediengesetzes (TMG) und des Bundesdatenschutzgesetzes (BDSG) beachtet. Bestands- und Nutzungsdaten des Kunden werden nur erhoben, verarbeitet oder genutzt, soweit dies für die Abwicklung des Vertragsverhältnisses erforderlich ist.

Ohne die Einwilligung des Kunden werden wir Daten des Kunden nicht für Zwecke der Werbung, Markt- oder Meinungsforschung nutzen.

## 8. Gesetzliche Vorschriften

Es liegt in der Verantwortung des Kunden, die gesetzlichen Vorschriften hinsichtlich des Im- und Exportes sowie des Verkaufs der von uns gelieferten Waren zu beachten.

## 9. Veredelung von Fremdware

Die Veredelung von Fremdware als Lohnarbeit erfolgt grundsätzlich auf Gefahr des Auftraggebers. Für die anfallenden Schäden haften wir nur, wenn uns oder unserem Erfüllungsgehilfen Vorsatz oder grobe Fahrlässigkeit zur Last fällt. In keinem Fall haften wir, wenn der Schaden durch einen Maschinenfehler entsteht. Dies gilt für alle Bereiche der Veredelung: Stick - Flock

## 10. Erfüllungsort

Erfüllungsort für Lieferung und Zahlung ist Freyung. Gerichtsstand für beide Teile ist Passau.

## 11. Verkauf in Internet-Auktions-Portalen

Der Verkauf unserer Artikel in Internet-Auktions-Portalen ist nur mit schriftlicher Genehmigung zulässig.

## 12. Schlussbestimmungen

Sollte eine oder mehrere der zwischen den Vertragsparteien vereinbarten Bestimmungen unwirksam sein oder werden, wird die Wirksamkeit der übrigen Bestimmungen nicht berührt.

**Fox**<sup>®</sup>  
Outdoor



**Pro**  
Company

**PURE**<sup>®</sup>  
TRASH